

XCT25L4_Y TRUCK CRANE

Technical Specifications

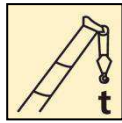

25 t

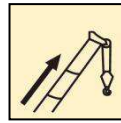

34 m

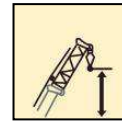

43.2 m



Dimensions (Right-hand drive)

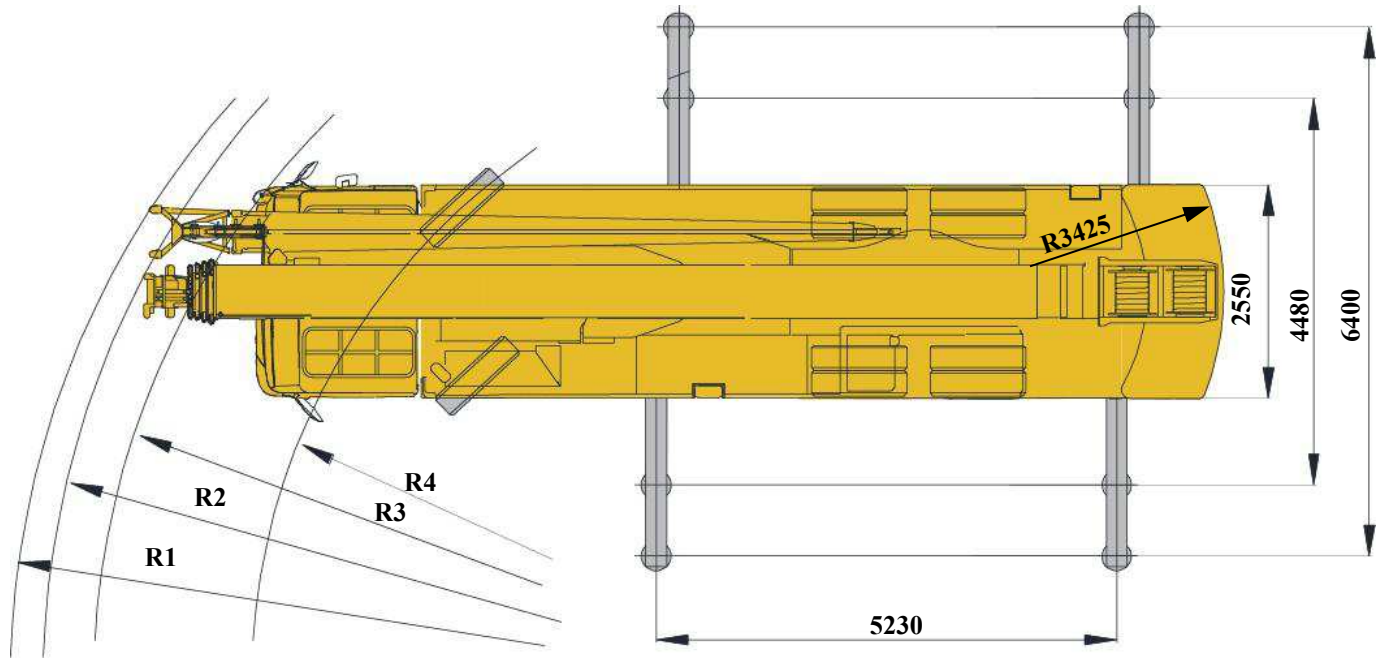
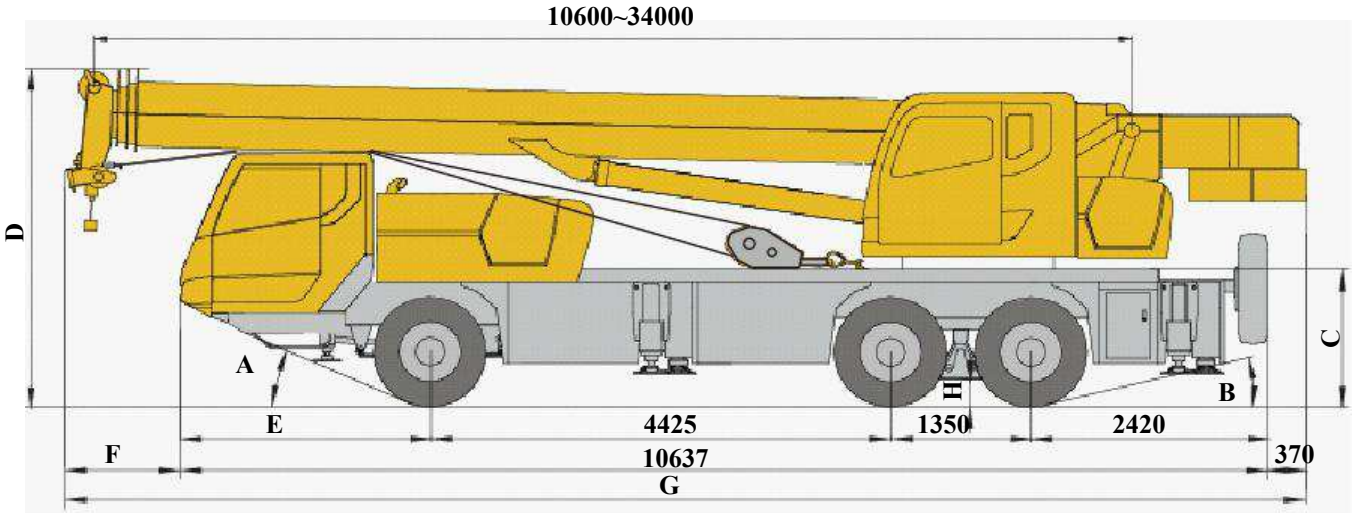

Type of Jib		A	B	C	D	E	F	G	R1	R2	R3	R4	H
Swing-away jib	11.00-20	16.5	13°	1392	3420	2442	1528	12535	12500	12250	11500	10000	261
Under slung jib	11.00-20	16.5	13°	1392	3920	2442	1935	12942	—	12500	11500	10000	261

Technical specifications

	Chassis	
Frame	Designed and manufactured by XCMG, it is made of high strength steel with fully covered walking surface and anti-torsion box-typed structure.	●
Outriggers	Four outriggers arranged in H-shape are hydraulically controlled by control levers. There is an outrigger control station located at each side of the chassis, and there is a level gauge on each control station. The outrigger movements can be simultaneously or separately controlled at any side of the chassis. There is a check valve fitted in each outrigger cylinder, and a double-way hydraulic valve fitted in each jack cylinder. Fifth jack is equipped. Longitudinal × lateral (fully-extended): 5.23 m×6.40 m Outrigger float diameter: φ400 mm 5th jack float diameter: φ260 mm Reaction force of outrigger at max. lifting load: 326 kN	●
Engine	SC7H260Q3, in-line, 6-cylinder, supercharged, intercooled diesel engine, made by Shanghai Diesel Engine, with rated power of 192 kW/2200 rpm, max. torque of 1000 Nm/1400 rpm, compliant with China III emission standard. Fuel tank capacity: 240 L.	● Right-hand drive
	SC7H260Q5, in-line, 6-cylinder, supercharged, intercooled diesel engine, made by Shanghai Diesel Engine, with rated power of 192kW/2300rpm, max. torque of 1000Nm/1200 ~ 1600rpm, compliant with China V emission standard. Fuel tank capacity: 240 L.	● Left-hand drive
Transmission	Mechanical transmission with a synchronizer, made by Shaanxi Fast Gear Co., Ltd., 8-forward speed and 2-reverse speed.	●
Axles	Three-axle chassis, Meritor single-stage reduction axle	● Right-hand drive
Tyres	11.00-20, suitable for heave load vehicles, strong commonality.	●
	Tyre specifications: 11.00 R20	○

Suspensions	Leaf springs with tapered cross-section are adopted for front suspensions, light dead weight and low noise; rubber spring suspensions with V-type push rods are adopted for rear axles, light dead weight and free of maintenance.	● Right-hand drive
Brakes	Double-circuit, air pressure brake, drum brake. Service brake: double-circuit air pressure brake acting on all wheels. Parking brake: air-release brake, acting on wheels of axles 2-3. Auxiliary brake: engine exhaust brake, which is safe and reliable, and will prolong the service life of brake lining.	●
Steering	Mechanically steering mechanism with a hydraulic booster	●
Drivers cab	New type, steel, full dimension cab with 4-point connecting structure, has swing-out doors at both sides. Manually adjustable driver's seat in height is available. A simple sleeper for the co-driver's seat is installed to supply comfort and reduce fatigue. The cab has better thermal insulation effect. Safety glass, electrically operated door window lifters, electrically adjusted mirrors make operation convenient and safe. Steering wheel is adjustable in height and angle. Heater and Air conditioner is standard.	●
Electrical system	24 V DC, two sets of 12 V battery in series. Generator output voltage is 28±0.3 V, and output current is 70 A.	●
S a f e t y devices	Double-way hydraulic valve	●
	ABS	○
	Yellow reflecting marking.	○
		● Right-hand drive

Technical specifications

	Superstructure	
Frame	Designed and manufactured by XCMG, made of high strength steel.	●
Hydraulic system	Constant displacement pump + load-sensing multi-way valve; with confluence technology adopted for multi-way valve, double-pump confluence can be realized when lifting, elevating or telescoping operation is carried out independently. Max. hoisting speed of main and auxiliary winches is up to 135 m/min. For simultaneous movements of main/auxiliary winch, telescoping or elevating, the two pumps supply oil separately.	●
Operating mode	Mechanical control	● Mechanical
	Pilot hydraulic proportional control through left and right levers is used for controlling the superstructure. Stepless speed regulation is available.	● Pilot
Main and Auxiliary Winch System	Hydraulic control is used for speed regulation. The system is driven by a hydraulic motor through a planetary gear reducer, with a normally closed brake, balance valve and a grooved drum equipped. It has features of high speed with a light load and low speed with a heavy load.	●
Slewing system	Single-row, contact-ball, external tooth slewing ring, with a single slewing gear located at right side, is driven by the planetary gear reducer of slewing mechanism, which is driven by a hydraulic motor, and may continuously slew 360°. Power control or free slewing function is available, and the slewing speed may be infinitely regulated.	●
Elevating system	Single cylinder with self-compensation balanced valve.	●
Operators Cab	Ergonomically designed, with swing-out door and adjustable seat. It is equipped with safe glass and roof protective grille. Windshield is equipped with sun visor. Air conditioning is standard.	●
	Extension of control lever	○ Mechanical

Counterweight	Fixed counterweight of 4.2 t.	●
Safety devices	Hydraulic balance valve; Hydraulic relief valve; Load moment limiter; Spring centering system for control levers; Lowering limiter for preventing wire rope from over releasing; Anti-two block at boom head for preventing wire rope from over-winding; Free sliding, slewing locking and tri colored light bar.	●
	Angle indicator	○
	winch monitoring device	○
	tri colored light bar	○
	beacon lamp	○
	Yellow reflecting marking.	○
	Hook block	25 t hook block , 3 t hook block 20 t hook block

Right-hand drive

Technical specifications

	Boom and jib system	
Boom	Four-section boom with U-shape profile, made of high strength steel, with special anti-deformation design. Single cylinder plus ropes is used to telescope the boom. Boom length: 10.6 m ~ 34 m	●
Single top	Fitted at boom head, used for single line operation. Its lifting performance is the same as that for boom, but the maximum lifting load does not exceed 2.8 t.	●
Swing-away jib	The jib consists of a connecting bracket, a rotating bracket and a foldable lattice jib. Three offset angles of 0°, 15° and 30° are available. It is stowed along the side of the boom. Fixed jib length: 8.3 m.	●
Under slung jib	Box-type under lung jib, with offset angles of 5°, 15° and 30°. Fixed jib length: 8.3 m.	○ Right-hand drive

Product parts list is as mentioned above. Please refer to the product quotation for specific parts.

Symbol explanation:

- —it means the standard configuration;
- —it means the optional configuration.

Weight





Axle	1	2	3	Total weight
t	5.90	10.80	10.80	27.50







Hook	Parts of line	Weight (kg)	Dimensions (mm)	Remarks
25t	10	297	1175×450×417	Single hook , Standard
20t	7	200	1249×430×268	Single hook , Optional
3t	1	60	518×236×236	Single hook , Standard

Working speeds



		
11.00-20	2 ~ 85	42%



Drive	Working speed	Max. single line pull	Rope diameter/ length
	0-135 m/min, single line, 4th layer	30 kN	14 mm/170 m
	0-135 m/min, single line, 4th layer	30 kN	14 mm/110 m
	0-3 r/min		
	Approx. 35 s for boom elevation from 0° to 80°		
	Approx. 53s for boom extension from 10.6 m to 34 m		

Boom / Jib combinations

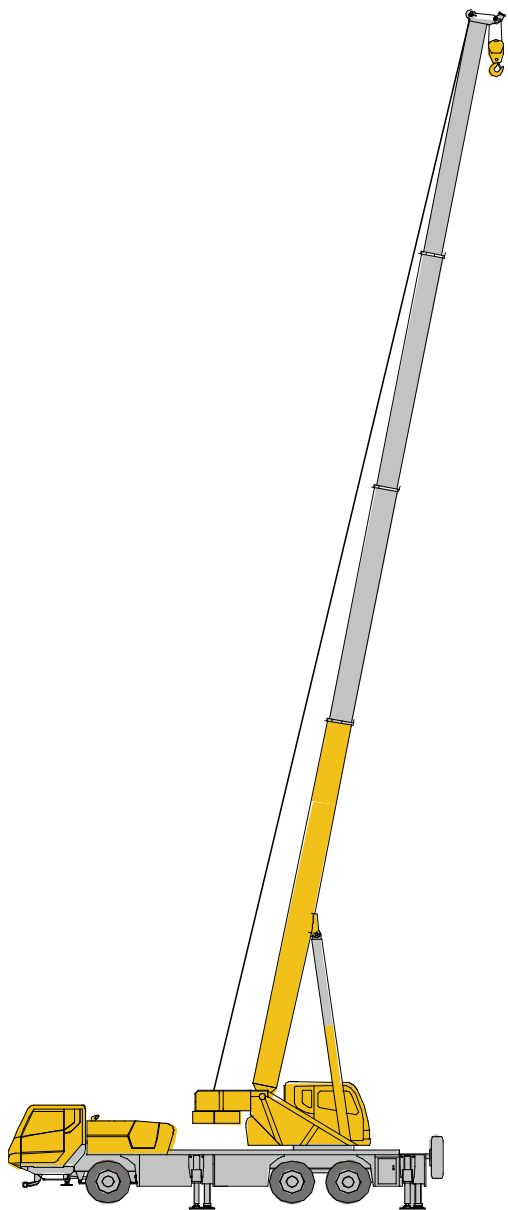

Telescopic boom

T: 10.6~34.0m

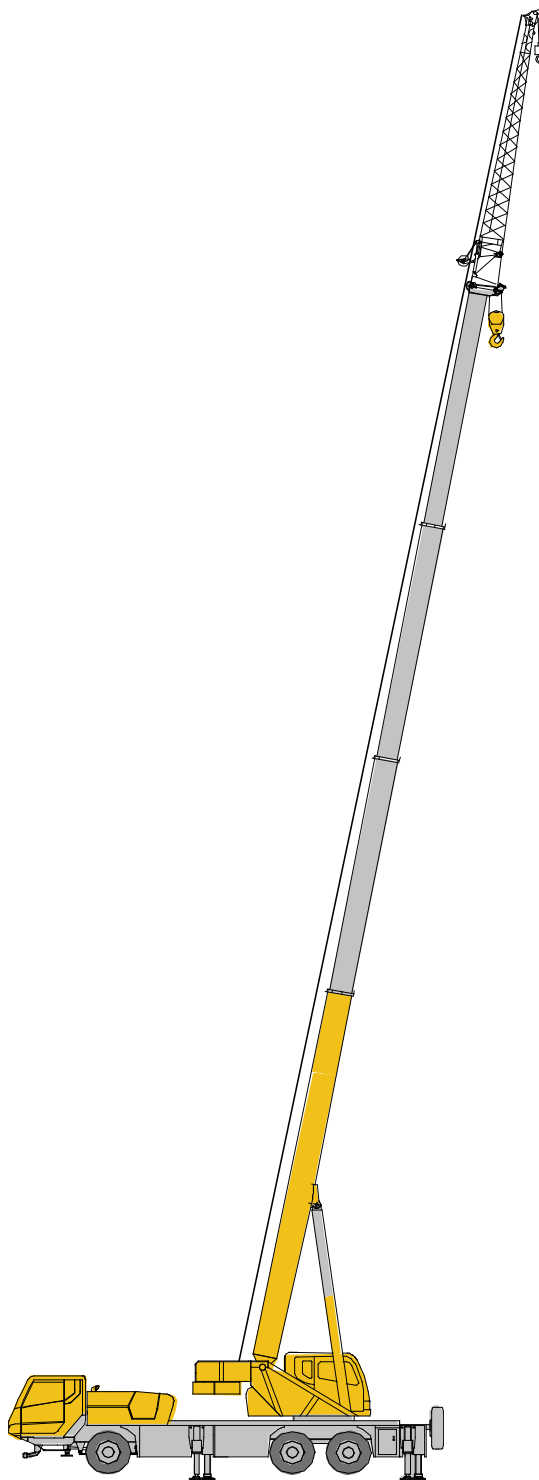

Jib

**T: 34.0m
J: 8.3 m**

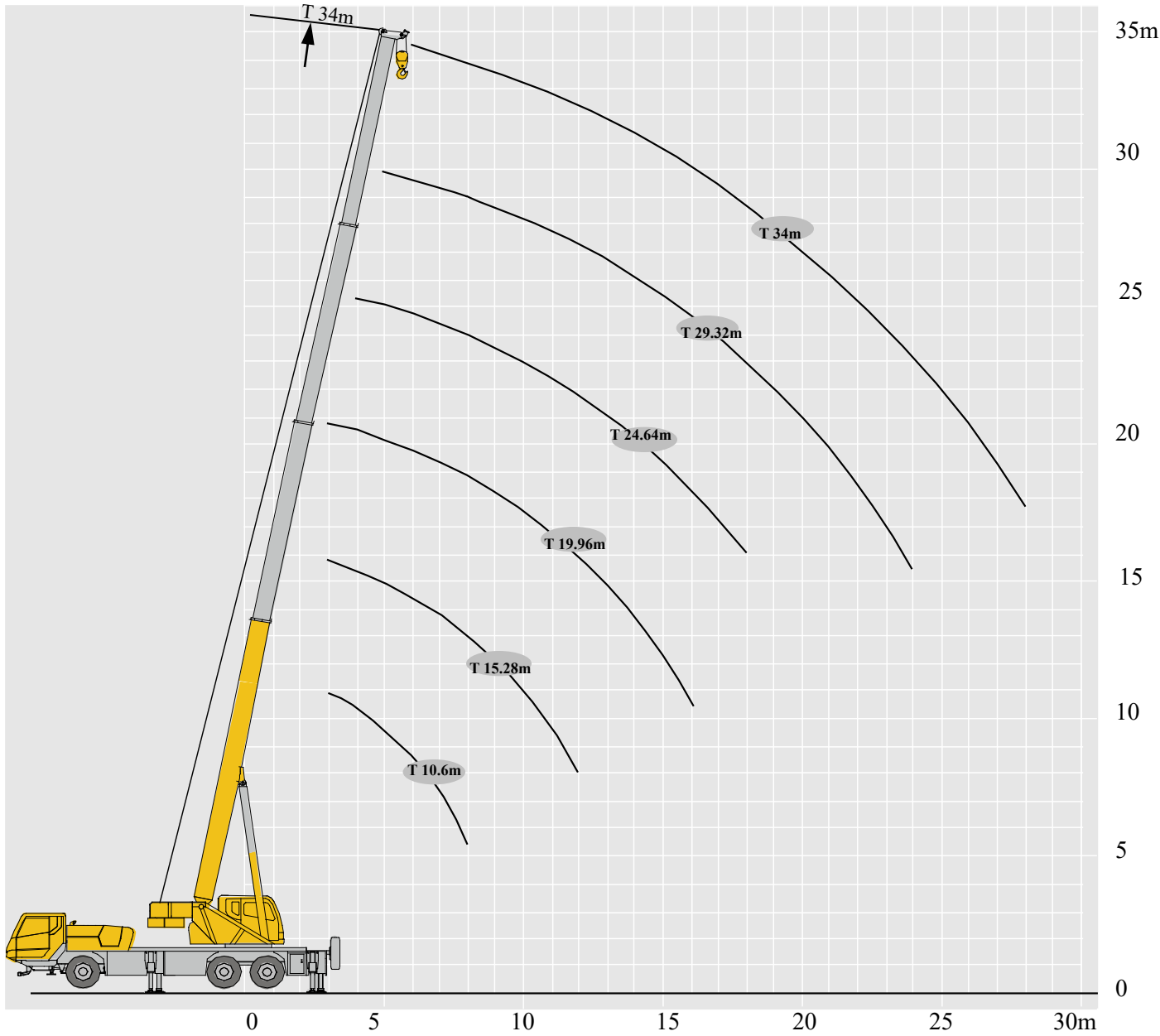





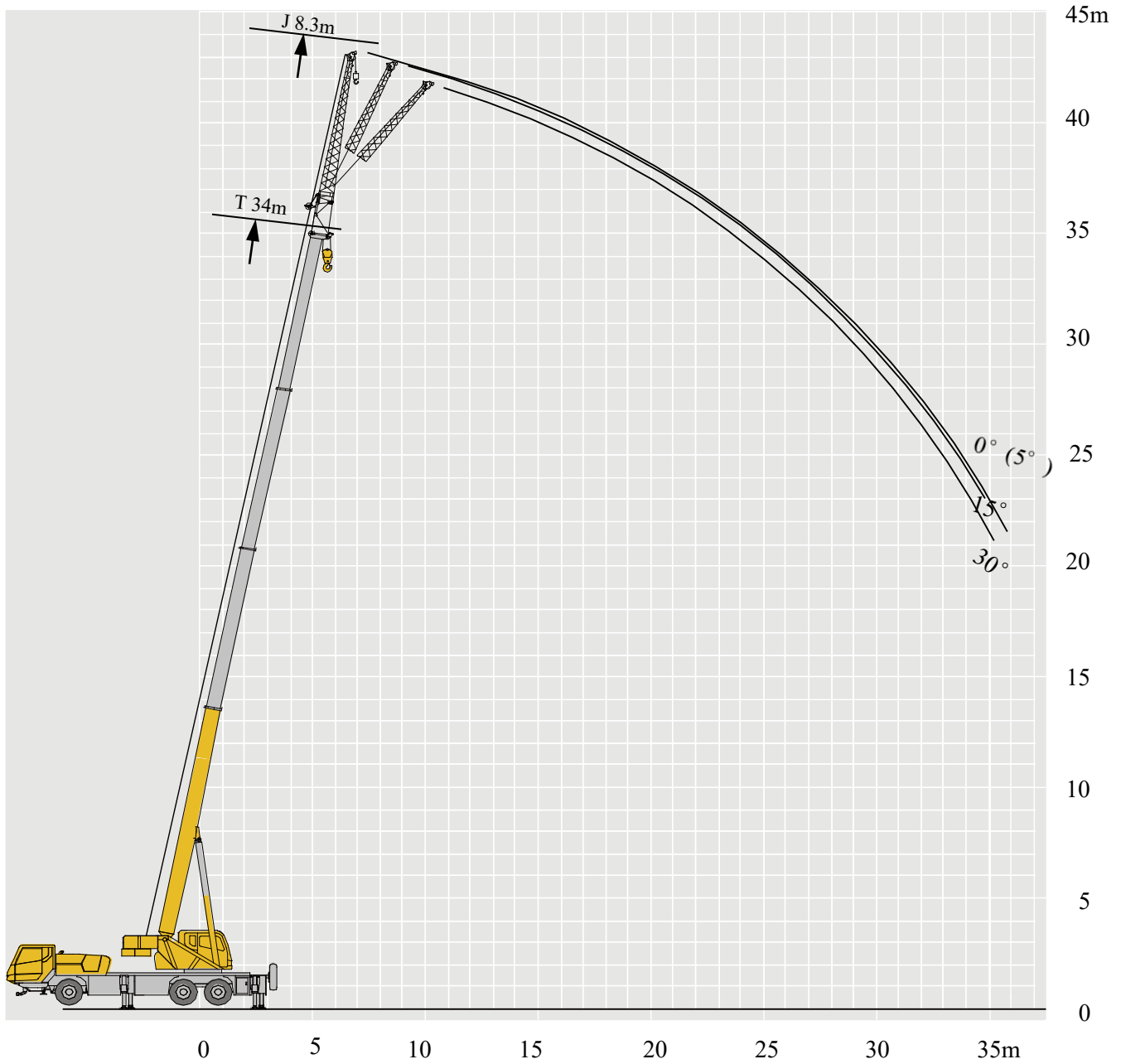

Lifting capacities

T 10.6~34m

	10.6m	15.28m	19.96m	24.64m	29.32m	34m	
3	25	16					3
3.5	23	16	16				3.5
4	22.5	16	16	13.5			4
4.5	21.7	16	16	13			4.5
5	19.7	16	16	12.8	10.5		5
5.5	17.7	16	15.2	12.5	10.5		5.5
6	15.9	15.5	14.3	11.8	10.5	6.9	6
7	12.1	12.6	12.8	10.8	10	6.9	7
8	9.9	10.4	10.6	9.8	9.2	6.9	8
9		8.5	8.7	8.8	8.4	6.7	9
10		7.1	7.3	7.4	7.5	6.3	10
12		5.2	5.3	5.4	5.5	5.3	12
14			4.1	4.2	4.2	4.3	14
16			3.2	3.3	3.3	3.4	16
18				2.6	2.7	2.75	18
20				2.1	2.1	2.2	20
22				1.6	1.7	1.8	22
24					1.4	1.45	24
26					1.1	1.2	26
28						0.9	28
30						0.7	30

The above rated load values are based on the crane being on firm level ground and are within 75% of tipping load



	   			
	0° (Swing-away jib) 5° (Under slung jib)	15°		30°
79	2.8	2	1.6	79
78	2.8	2	1.6	78
76	2.8	1.85	1.5	76
74	2.7	1.8	1.45	74
72	2.6	1.75	1.4	72
70	2.45	1.6	1.35	70
68	2.35	1.55	1.3	68
66	2.2	1.45	1.25	66
64	2.05	1.35	1.2	64
62	1.9	1.25	1.15	62
60	1.75	1.15	1.1	60
58	1.65	1.05	1.05	58
56	1.5	1	1	56
54	1.25	0.95	0.95	54
52	1.1	0.9	0.9	52
50	1	0.85	0.75	50
45	0.75	0.55	0.55	45
40	0.55	0.45	0.45	40
35	0.4	0.3	0.3	35
30	0.25			30

The above rated load values are based on the crane being on firm level ground and are within 75% of tipping load

Notes

1. The total rated loads given in the rated load charts are the maximum lifting capacity when the crane is set up on firm and level ground, which includes the weight of the hook block and slings. The weight of above-mentioned devices should be deducted from the rated lifting load. The above rated load values are based on the crane being on firm level ground and are within 75% of tipping load.
2. The working radius shown in the rated load charts is the radius when the load is lifted off the ground, and it is the actual value including loaded boom deflection. Take boom deflection into consideration before beginning a lifting operation.
3. A lifting operation is permissible only when the wind force is below grade 5 (instantaneous wind speed is 14.1 m/s, wind pressure is 125 N/m²).
4. Before beginning lifting operation, the operator should know the weight of the load to be lifted and its working range, and then select proper working conditions. Never operate the crane beyond the limit shown in the chart. Use the lower value from the chart when the boom length or working radius is between the range of values.
5. Observe the boom angle limit. Never operate the crane with the boom angle beyond the recommended limit even if a load is not being carried. Otherwise, the crane will tip.
6. The boom should be extended according to the telescoping code shown by percentage (or digits, which means the percentage of boom sections extended).

Description of symbols

General symbols





















	Superstructure		Chassis
	Lifting capacity		Axle
	Boom length		Driving speed
	Radius		Grade ability
	Boom angle		Tires
	Hoist height with boom		Outriggers
	Fixed jib length		Hook block
	Jib offset angle		Counterweight
	Hoist height with jib		Winch
	Boom over side or over rear of the crane without 5th jack		360° operation of the boom
	360° operation of the boom with 5th jack down		

Table of main technical parameters

Category	Item		Unit	Parameter
				(Right-hand drive)
Dimensions	Dimensions (length×width×height)		mm	12535×2550×3420 (Swing-away jib)
				12942×2550×3920 (Under lung jib)
	Wheel base		mm	4425+1350
	Track (Front/ Rear)		mm	2055/1834
	Front/ Rear overhang		mm	2442/2420
	Front/ Rear extension		mm	1528/370 (Swing-away jib)
1935/370 (Under lung jib)				
Weight	Total vehicle mass in travel configuration		kg	27500
	Axle load	1st axle	kg	5900
		2nd axle	kg	10800
		3rd axle	kg	10800
Power	Engine model		—	SC7H260Q3
	Engine rated power/rpm		kW/(r/min)	192/2200
	Max. net power/rpm		kW/(r/min)	188/2200
	Max. output torque/rpm		N.m/(r/min)	1000/1400
Travel	Max. travel speed		km/h	≥85
	Min. stable travel speed		km/h	2 ~ 3
	Min. turning diameter		m	≤20
	Min. turning diameter at boom tip		m	≤25
	Min. ground clearance		mm	261
	Approach angle		°	16.5
	Departure angle		°	13
	Braking distance (at 30 km/h)		m	≤10
	Max. grade ability		%	≥42
	Fuel consumption per 100 km		L	30
Noise	Exterior noise level		dB(A)	≤84
	Noise level at seated position		dB(A)	≤90

Table of main technical parameters

Category	Item		Unit	Parameter	
				Right-hand drive	
Main performance	Max. total rated lifting capacity		t	25	
	Min. rated working radius		m	3	
	Turning radius at turntable tail		mm	3425	
	Max. load moment	Base boom		kN.m	965
		Fully-extended boom		kN.m	623
		Fully-extended boom + Jib		kN.m	370
	Outrigger span	Longitudinal		m	5.23
		Lateral		m	6.4
	Hoist height	Base boom		m	10.9
		Fully-extended boom		m	34.5
		Fully-extended boom + Jib		m	43.2
	Boom length	Base boom		m	10.6
		Fully-extended boom		m	34
		Fully-extended boom + Jib		m	42.3
Jib offset angle			°	0, 15, 30 (Swing-away jib)	
				5, 15, 30 (Under slung jib)	
Working speed	Boom raising time		s	≤35	
	Boom fully extending time		s	≤53	
	Max. slewing speed		r/min	≥3	
	Outrigger extending and retracting time	Horizontal Outrigger	Retracting	s	≤20
			Extending	s	≤25
		Vertical Outrigger	Retracting	s	≤20
			Extending	s	≤25
	Hoisting speed (single line, 4th layer, no load)	Main winch		m/min	≥135
Auxiliary winch		m/min	≥135		
Noise	Exterior noise level		dB (A)	≤120	
	Noise level at seated position		dB (A)	≤90	



CRANES AUSTRALIA

KERRY FULLBROOK

TECHNICAL SALES

MOBILE: 0448 373 370

EMAIL: KERRY@XCMGCRANESAUS.COM.AU

HEAD OFFICE : 415 SOUTH GIPPSLAND

HWY, DANDENONG STH, VIC 3175

PH: 9799 8699

WWW.XCMGCRANESAUSTRALIA.COM.AU