

Slewing tower crane

WOLFF 7032.8 clear

Technical information

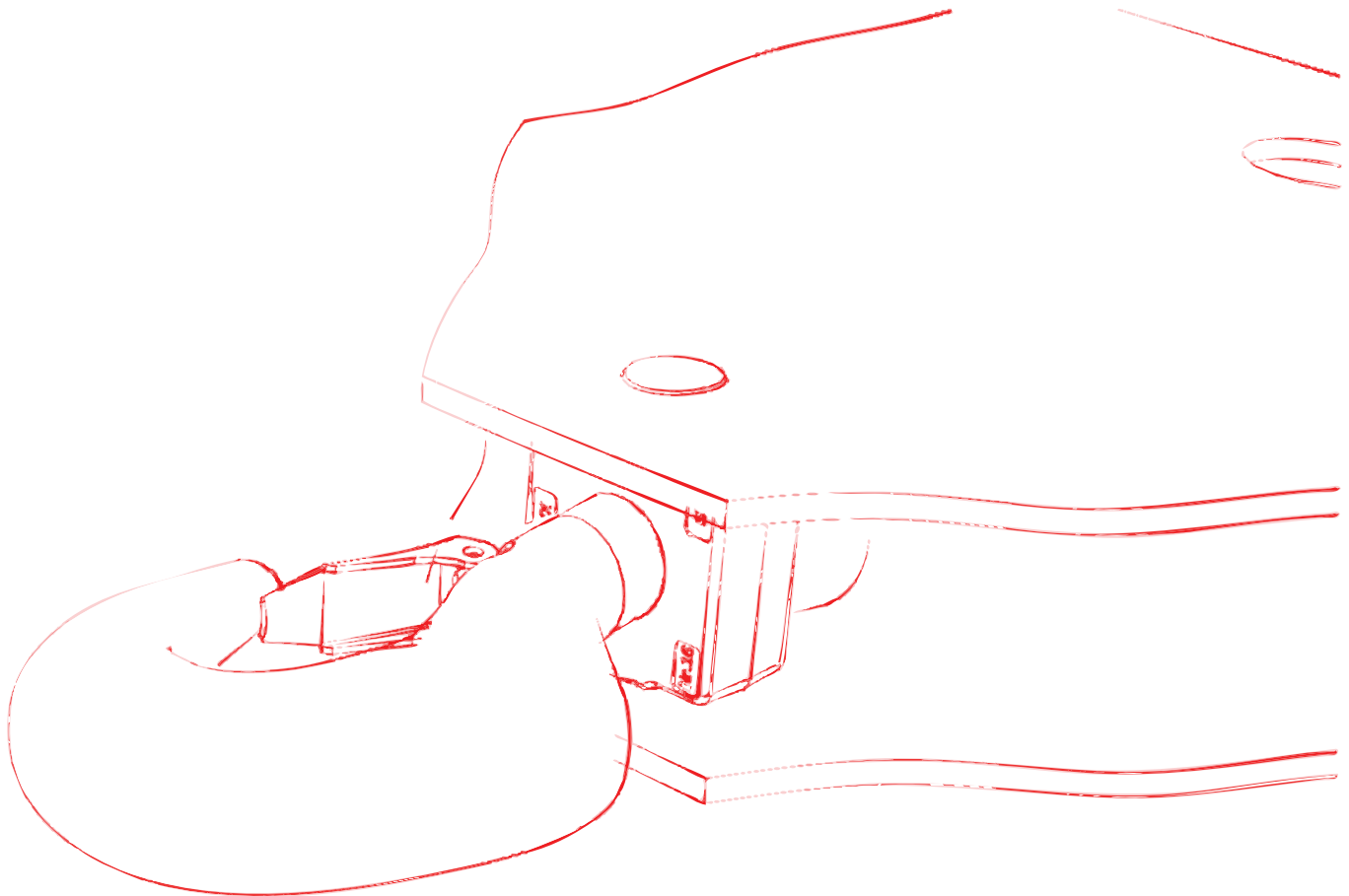

English

English



Published by

WOLFFKRAN GmbH

Austraße 72

74076 Heilbronn

Germany

Phone +49 7131 9815 0

Fax +49 7131 9815 355

www.wolffkran.com

info@wolffkran.de

Copyright

This documentation including all of its subsections is protected by copyright laws.

Any type of use or modification outside of the stringent limits of the copyright laws without permission of WOLFFKRAN GmbH is prohibited and subject to penalties.

This applies particularly for copying, translation, microfilming and storage and processing in electronic systems.

At the time of printing, the information, data, illustrations and notes comprised in this manual were up-to-date.

Subject to change of design, error and typos.

Stand: 03/2017

Table of contents

1	Schedule drawing	5
1.1	Schedule drawing WOLFF 7032.8clear	5
2	Load carrying capacities	6
2.1	Table of load carrying capacity WOLFF 7032.8 clear (8.5 t, 2 fall operation)	7
2.2	Table of load carrying capacities (kg) in meter intervals, WOLFF 7032.8 (8.5 t, 2 fall operation)	8
3	Tower combinations	9
3.1	Tower combinations on foundation (slewing section with UV 20 / TV 20 - connection)	10
3.2	Tower combinations on cross frame (slewing section with UV 20 - connection)	18
3.3	Tower combinations on cross frame element (slewing section with UV 20 - connection)	30
3.4	Tower combinations on city portal (slewing section with UV 20 - connection)	32
3.5	Tower combinations on mobile cross frame (slewing section with UV 20 - connection)	34
3.6	Tower combinations on undercarriage (slewing section with UV 20 - connection)	48
4	Foundation loads / central ballast weights / corner loads in compliance with EN 14439 / EN 13001	51
4.1	Foundation loads jib 25 m - 50 m	53
4.2	Foundation loads jib 52.5 m - 70 m	54
5	Operating speeds	55
6	Package list	57
6.1	Package list 7032.8	57
7	Assembly weights	59
7.1	Counterweight blocks	59
7.1.1	Counterweight block, 2.7 t	60
7.2	Total weight jib assembly	61
7.3	Assembly weight slewing section	62
7.4	Assembly weight cross frame	63
7.5	Assembly weights traveling cross frame	64
7.6	Assembly weight cross frame elements	66
7.7	Assembly weight undercarriage	67

7.8	Assembly weights city portal	68
7.9	Required hook height for mobile cranes	69
8	Assembly diagrams	70
8.1	Jib attachment diagram	70
8.1.1	Trolley jib - attachment diagram 70 m to 65 m	71
8.1.2	Trolley jib - attachment diagram 62.5 m to 57.5 m	72
8.1.3	Trolley jib - attachment diagram 55 m to 50 m	73
8.1.4	Trolley jib - attachment diagram 47.5 m to 42.5 m	74
8.1.5	Trolley jib - attachment diagram 40 m to 35 m	75
8.1.6	Trolley jib - attachment diagram 32.5 m to 27.5 m	76
8.1.7	Trolley jib - attachment diagram 25 m	77
8.2	Counterjib lifting diagram	78
8.3	Jib brace diagram	80
8.4	Counterjib brace diagram	81
8.5	Trolley jib mounting rig	82
8.6	Arrangement of standard railings	84
8.6.1	Standard railings (NG) and accessories	84
8.6.2	Arrangement of standard railings	85
9	Suitable climbing devices	87
9.1	Outer climbing devices	88
9.1.1	Outer climbing device KWH 20.3 / KWH 20.3.1	89
9.1.2	Outer climbing device KWH 20.6 / KWH 20.6.1 / KWH 20.6.2	90
9.2	Inner climbing devices	91
9.2.1	Inner climbing device KSH 20 SH	92
10	Arrangement of counterweight blocks	95

1 Schedule drawing

1.1 Schedule drawing WOLFF 7032.8clear

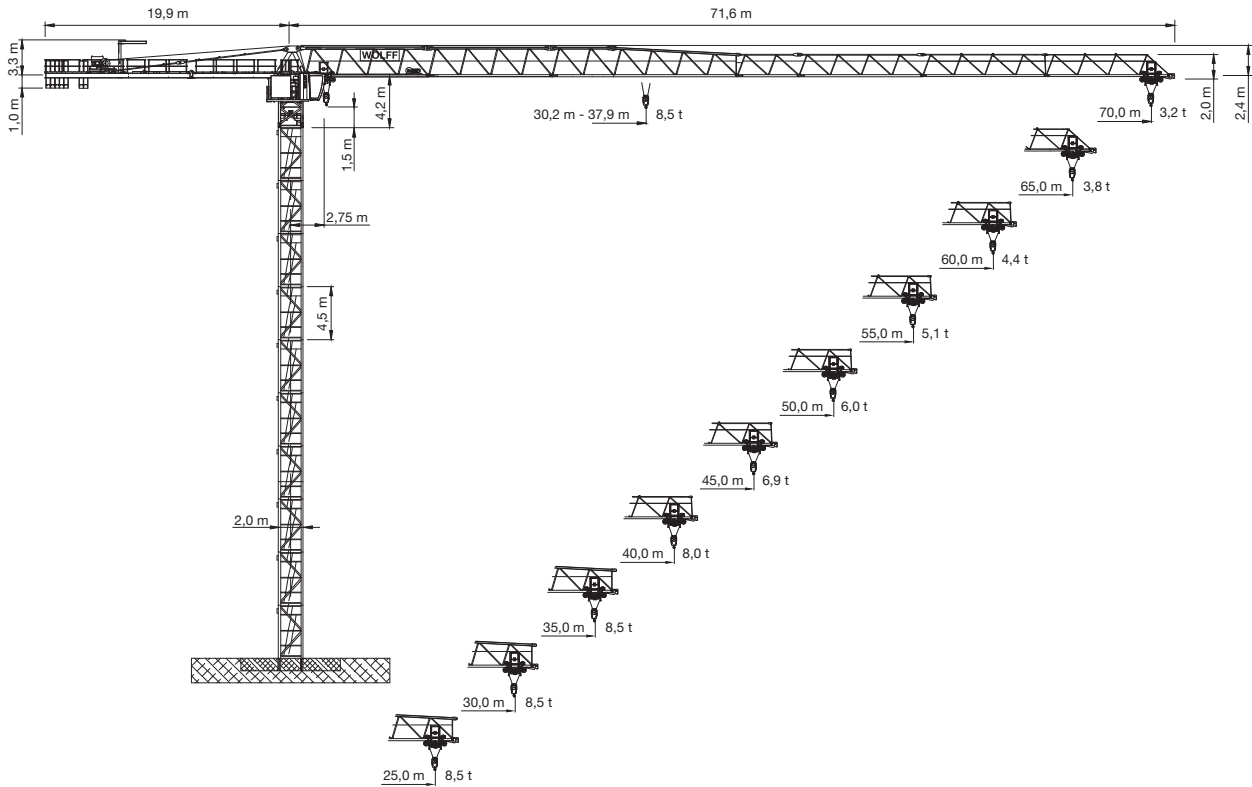

Data WOLFF 7032.8

Item	Data
Crane type	BGL GROUP C.0.10.0250
Design	Overhead travelling crane with top slewing trolley jib, with climbing feature
Type of setup	Stationary or travelling
Basis of calculation	EN 14439 (C25)
Payload torque	max. 3221 kNm
Hoist winch	Hw 845 FU / Hw 875 FU

2 Load carrying capacities

2 Load carrying capacities

	<h3>NOTICE</h3>
<p>WOLFF-Boost</p> <p>With the WOLFF-Boost function, the load is allowed to exceed the load torque range specified for the lifting capacities by up to 10%. This is, however, subject to the restriction that hoisting gear and trolley drive (trolley crane) respectively hoisting gear and derricking gear (luffing crane) must only be moved alternately.</p>	

2.1 Table of load carrying capacity WOLFF 7032.8 clear (8.5 t, 2 fall operation)

 8.5 t		Operating radius [m]	25.0	27.5	30.0	32.5	35.0	37.5	40.0	42.5	45.0	47.5	50.0	52.5	55.0	57.5	60.0	62.5	65.0	67.5	70.0
			JL [m]	70.0	2.75 - 30.2	8.5	8.5	8.5	7.9	7.2	6.7	6.2	5.8	5.4	5.1	4.8	4.5	4.3	4.1	3.9	3.7
	67.5	2.75 - 31.3	8.5	8.5	8.5	8.2	7.5	7.0	6.5	6.0	5.7	5.3	5.0	4.7	4.5	4.3	4.0	3.8	3.7	3.5	
	65.0	2.75 - 32.3	8.5	8.5	8.5	8.4	7.8	7.2	6.7	6.3	5.9	5.5	5.2	4.9	4.6	4.4	4.2	4.0	3.8		
	62.5	2.75 - 33.0	8.5	8.5	8.5	8.5	8.0	7.4	6.9	6.4	6.0	5.7	5.3	5.0	4.8	4.5	4.3	4.1			
	60.0	2.75 - 33.6	8.5	8.5	8.5	8.5	8.1	7.5	7.0	6.6	6.1	5.8	5.4	5.1	4.9	4.6	4.4				
	57.5	2.75 - 34.4	8.5	8.5	8.5	8.5	8.3	7.7	7.2	6.7	6.3	5.9	5.6	5.3	5.0	4.8					
	55.0	2.75 - 35.0	8.5	8.5	8.5	8.5	8.5	7.9	7.3	6.8	6.4	6.0	5.7	5.4	5.1						
	52.5	2.75 - 35.6	8.5	8.5	8.5	8.5	8.5	8.0	7.5	7.0	6.6	6.2	5.8	5.5							
	50.0	2.75 - 36.6	8.5	8.5	8.5	8.5	8.5	8.3	7.7	7.2	6.8	6.4	6.0								
	47.5	2.75 - 37.3	8.5	8.5	8.5	8.5	8.5	8.5	7.9	7.4	6.9	6.5									
	45.0	2.75 - 37.3	8.5	8.5	8.5	8.5	8.5	8.5	7.9	7.4	6.9										
	42.5	2.75 - 37.5	8.5	8.5	8.5	8.5	8.5	8.5	7.9	7.4											
	40.0	2.75 - 37.9	8.5	8.5	8.5	8.5	8.5	8.5	8.0												
	37.5	2.75 - 37.5	8.5	8.5	8.5	8.5	8.5	8.5													
	35.0	2.75 - 35.0	8.5	8.5	8.5	8.5	8.5														
	32.5	2.75 - 32.5	8.5	8.5	8.5	8.5															
	30.0	2.75 - 30.0	8.5	8.5	8.5																
	27.5	2.75 - 27.5	8.5	8.5																	
	25.0	2.75 - 25.0	8.5																		

Caption	
JL	Jib length
LCC	Load carrying capacity

The load carrying capacity is related to a hook range of 42.0 m. Hook ranges greater than that reduce the maximum load carrying capacity by the weight of the additional hoisting rope.

2 Load carrying capacities

2.2 Table of load carrying capacities (kg) in meter intervals, WOLFF 7032.8 (8.5 t, 2 fall operation)

Operating radius [m]	Jib length [m]																		
	25.0	27.5	30.0	32.5	35.0	37.5	40.0	42.5	45.0	47.5	50.0	52.5	55.0	57.5	60.0	62.5	65.0	67.5	70.0
25.0	8500	8500	8500	8500	8500	8500	8500	8500	8500	8500	8500	8500	8500	8500	8500	8500	8500	8500	8500
26.0		8500	8500	8500	8500	8500	8500	8500	8500	8500	8500	8500	8500	8500	8500	8500	8500	8500	8500
27.0		8500	8500	8500	8500	8500	8500	8500	8500	8500	8500	8500	8500	8500	8500	8500	8500	8500	8500
27.5		8500	8500	8500	8500	8500	8500	8500	8500	8500	8500	8500	8500	8500	8500	8500	8500	8500	8500
28.0			8500	8500	8500	8500	8500	8500	8500	8500	8500	8500	8500	8500	8500	8500	8500	8500	8500
29.0			8500	8500	8500	8500	8500	8500	8500	8500	8500	8500	8500	8500	8500	8500	8500	8500	8500
30.0			8500	8500	8500	8500	8500	8500	8500	8500	8500	8500	8500	8500	8500	8500	8500	8500	8500
31.0				8500	8500	8500	8500	8500	8500	8500	8500	8500	8500	8500	8500	8500	8500	8500	8270
32.0				8500	8500	8500	8500	8500	8500	8500	8500	8500	8500	8500	8500	8500	8500	8300	7990
32.5				8500	8500	8500	8500	8500	8500	8500	8500	8500	8500	8500	8500	8500	8430	8160	7850
33.0					8500	8500	8500	8500	8500	8500	8500	8500	8500	8500	8500	8500	8290	8030	7720
34.0					8500	8500	8500	8500	8500	8500	8500	8500	8500	8500	8400	8230	8020	7770	7470
35.0					8500	8500	8500	8500	8500	8500	8500	8500	8490	8340	8140	7970	7770	7520	7230
36.0						8500	8500	8500	8500	8500	8400	8230	8080	7890	7730	7530	7290	7010	
37.0						8500	8500	8500	8500	8500	8400	8150	7980	7840	7650	7500	7300	7070	6790
37.5						8500	8500	8500	8450	8450	8280	8030	7870	7730	7540	7390	7200	6960	6690
38.0							8460	8370	8320	8330	8160	7920	7750	7610	7430	7280	7090	6860	6590
39.0							8230	8140	8090	8100	7930	7690	7530	7400	7220	7070	6890	6660	6400
40.0							8000	7910	7870	7870	7710	7480	7320	7190	7020	6870	6690	6480	6220
41.0								7700	7650	7660	7500	7280	7120	7000	6820	6690	6510	6300	6050
42.0								7500	7450	7460	7300	7080	6940	6810	6640	6510	6340	6130	5890
42.5								7400	7350	7360	7210	6990	6840	6720	6550	6420	6250	6050	5810
43.0									7260	7270	7110	6900	6750	6630	6470	6340	6170	5970	5730
44.0									7080	7080	6930	6720	6580	6460	6300	6170	6010	5810	5580
45.0									6900	6910	6760	6560	6420	6300	6140	6020	5860	5670	5440
46.0										6740	6590	6390	6260	6150	5990	5870	5710	5520	5300
47.0										6580	6440	6240	6110	6000	5850	5730	5570	5390	5170
47.5										6500	6360	6170	6040	5920	5780	5660	5510	5320	5110
48.0											6280	6090	5960	5850	5710	5590	5440	5260	5050
49.0											6140	5950	5830	5720	5570	5460	5310	5130	4930
50.0											6000	5820	5690	5590	5450	5330	5190	5020	4810
51.0												5690	5570	5460	5320	5210	5070	4900	4700
52.0												5560	5440	5340	5200	5100	4960	4790	4600
52.5												5500	5380	5280	5150	5040	4900	4740	4540
53.0													5320	5220	5090	4980	4850	4680	4490
54.0														5210	5110	4980	4880	4740	4580
55.0														5100	5000	4880	4770	4640	4480
56.0															4900	4770	4670	4540	4390
57.0																4800	4680	4580	4450
57.5																4750	4630	4530	4400
58.0																	4580	4480	4360
59.0																	4490	4390	4270
60.0																	4400	4310	4190
61.0																		4220	4100
62.0																		4140	4020
62.5																		4100	3990
63.0																			3950
64.0																			3870
65.0																			3800
66.0																			3670
67.0																			3670
67.5																			3500
68.0																			3350
69.0																			3320
70.0																			3260
																			3200

3 Tower combinations



! DANGER

Usage of incorrect tower combinations.

The slewing tower crane may overturn.

- 1) Use the specified tower combinations.
- 2) If you need another tower combination that is not specified here, please contact WOLFFKRAN to get an approved alternative setup in writing.



NOTICE

All tower combinations apply to free standing slewing tower cranes without climbing gear.

3 Tower combinations

3.1 Tower combinations on foundation (slewing section with UV 20 / TV 20 - connection)

Jib length	25 m – 50 m				
Item					
1	4.5 m	UV 20.4	TV 20.4	UV 20.4	
2	9.0 m	UV 20.4	TV 20.4	UV 20.4	
3	13.5 m	UV 20.4	TV 20.4	UV 20.4	
4	18.0 m	UV 20.4	TV 20.4	UV 20.4	
5	22.5 m	UV 20.4	TV 20.4	UV 20.4	
6	27.0 m	UV 20.4	TV 20.4	UV 20.4	
7	31.5 m	UV 20.4	TV 20.4	UV 20.4	
8	36.0 m	UV 20.4	TV 20.4	TVA 20.4	
9	40.5 m	UV 20.4	TV 20.4	TV 20.4	
10	45.0 m		TV 20.4	TV 20.4	
11	49.5 m		TV 20.4	TV 20.4	
12	54.0 m		TV 20.4	TV 20.4	
13	58.5 m		TV 20.4	TV 20.4	
14	63.0 m		TV 20.4	TV 20.4	
15	67.5 m		TV 20.4	TV 20.4	
16	72.0 m			TV 20.4	
Foundation anchors		FUA 120 / Type C-120	FUA 140 / Type D-140	FUA 140 / Type D-140	
Tower height [m]		40.5	67.5	72.0	
Hook height 2 fall operation [m]		42.0	69.0	73.5	
Wind category		C 25			

3 Tower combinations

Jib length	52.5 m – 70 m				
Item					
1	4.5 m	UV 20.4	TV 20.4	UV 20.4	
2	9.0 m	UV 20.4	TV 20.4	UV 20.4	
3	13.5 m	UV 20.4	TV 20.4	UV 20.4	
4	18.0 m	UV 20.4	TV 20.4	UV 20.4	
5	22.5 m	UV 20.4	TV 20.4	UV 20.4	
6	27.0 m	UV 20.4	TV 20.4	UV 20.4	
7	31.5 m	UV 20.4	TV 20.4	UV 20.4	
8	36.0 m	UV 20.4	TV 20.4	TVA 20.4	
9	40.5 m	UV 20.4	TV 20.4	TV 20.4	
10	45.0 m		TV 20.4	TV 20.4	
11	49.5 m		TV 20.4	TV 20.4	
12	54.0 m		TV 20.4	TV 20.4	
13	58.5 m		TV 20.4	TV 20.4	
14	63.0 m		TV 20.4	TV 20.4	
15	67.5 m			TV 20.4	
Foundation anchors		FUA 120 / Type C-120	FUA 140 / Type D-140	FUA 140 / Type D-140	
Tower height [m]		40.5	63.0	67.5	
Hook height 2 fall operation [m]		42.0	64.5	69.0	
Wind category		C 25			

3 Tower combinations

Jib length	52.5 m – 70 m				
Item					
1	4.5 m	UV 20.4			
2	9.0 m	UV 20.4			
3	13.5 m	UV 20.4			
4	18.0 m	UV 20.4			
5	22.5 m	UV 20.4			
6	27.0 m	UV 20.4			
7	31.5 m	UV 20.4			
8	36.0 m	TVA 20.4			
9	40.5 m	TV 20.4			
10	45.0 m	TV 20.4			
11	49.5 m	TV 20.4			
12	54.0 m	TV 20.4			
13	58.5 m	TV 20.4			
14	59.5 m	VR 2023			
15	64.0 m	TV 23			
16	68.5 m	HTA 23			
17	73.0 m	HT 23			
18	77.5 m	HT 23			
19	88.8 m	BT 23			
Foundation anchors		FUA G 210			
Tower height [m]		88.8			
Hook height 2 fall operation [m]		90.3			
Wind category			C 25		

3 Tower combinations

3.2 Tower combinations on cross frame (slewing section with UV 20 - connection)

Jib length		25 m – 50 m			
Item					
1	4.5 m	UV 20.4	UV 20.4	UV 20.4	
2	9.0 m	UV 20.4	UV 20.4	UV 20.4	
3	13.5 m	UV 20.4	UV 20.4	UV 20.4	
4	18.0 m	UV 20.4	UV 20.4	UV 20.4	
5	22.5 m	UV 20.4	UV 20.4	UV 20.4	
6	27.0 m	UV 20.4	UV 20.4	UV 20.4	
7	31.5 m	UV 20.4	UV 20.4	UV 20.4	
8	36.0 m	UV 20.4	UV 20.4	TVA 20.4	
9	40.5 m	TVA 20.4	TVA 20.4	TV 20.4	
10	45.0 m	TV 20.4	TV 20.4	TV 20.4	
11	49.5 m	TV 20.4	TV 20.4	TV 20.4	
12	54.0 m	TV 20.4	TV 20.4	TV 20.4	
13	58.5 m	TV 20.4		TV 20.4	
14	63.0 m			TV 20.4	
15	67.5 m			TV 20.4	
Substructure		KR 10-46	KR 10-46/60	KRV 10-60	
Corner distance [m x m]		4.6 x 4.6	6.0 x 6.0	5.0 x 5.0 6.0 x 6.0	
Substructure height [m]		1.2	1.2	1.2	
Tower height [m]		59.7	55.2	68.7	
Hook height 2 fall operation [m]		61.2	56.7	70.2	
Wind category		C 25			

Jib length	25 m – 50 m			
Item				
1	4.5 m	UV 20.4		
2	9.0 m	UV 20.4		
3	13.5 m	UV 20.4		
4	18.0 m	UV 20.4		
5	22.5 m	UV 20.4		
6	27.0 m	UV 20.4		
7	31.5 m	UV 20.4		
8	36.0 m	TVA 20.4		
9	40.5 m	TV 20.4		
10	45.0 m	TV 20.4		
11	49.5 m	TV 20.4		
12	54.0 m	TV 20.4		
13	58.5 m	TV 20.4		
14	63.0 m	TV 20.4		
15	64.0 m	VR 2023		
16	68.5 m	TV 23		
17	73.0 m	TV 23		
Substructure		KRV 10-60		
Corner distance [m x m]		5.0 x 5.0 6.0 x 6.0		
Substructure height [m]		1.2		
Tower height [m]		74.2		
Hook height 2 fall operation [m]		75.7		
Wind category				C 25

3 Tower combinations

Jib length	25 m – 50 m			
Item				
1	4.5 m	UV 20.4		
2	9.0 m	UV 20.4		
3	13.5 m	UV 20.4		
4	18.0 m	UV 20.4		
5	22.5 m	UV 20.4		
6	27.0 m	UV 20.4		
7	31.5 m	UV 20.4		
8	36.0 m	TVA 20.4		
9	40.5 m	TV 20.4		
10	45.0 m	TV 20.4		
11	49.5 m	TV 20.4		
12	54.0 m	TV 20.4		
13	58.5 m	TV 20.4		
14	63.0 m	TV 20.4		
15	67.5 m	TV 20.4		
Substructure		KR 12-60 KR 12-60/80		
Corner distance [m x m]		6.0 x 6.0 8.0 x 8.0		
Substructure height [m]		1.4		
Tower height [m]		68.9		
Hook height 2 fall operation [m]		70.4		
Wind category			C 25	

Jib length	25 m – 50 m			
Item				
1	4.5 m	UV 20.4	UV 20.4	
2	9.0 m	UV 20.4	UV 20.4	
3	13.5 m	UV 20.4	UV 20.4	
4	18.0 m	UV 20.4	UV 20.4	
5	22.5 m	UV 20.4	UV 20.4	
6	27.0 m	UV 20.4	UV 20.4	
7	31.5 m	TVA 20.4	TVA 20.4	
8	36.0 m	TV 20.4	TV 20.4	
9	40.5 m	TV 20.4	TV 20.4	
10	45.0 m	TV 20.4	TV 20.4	
11	49.5 m	TV 20.4	TV 20.4	
12	54.0 m	TV 20.4	TV 20.4	
13	58.5 m	TV 20.4	TV 20.4	
14	63.0 m	TV 20.4	TV 20.4	
15	64.0 m	VR 2023	VR 2023	
16	68.5 m	TV 23	TV 23	
17	73.0 m	TV 23	HTA 23	
18	77.5 m	HTA 23	HT 23	
19	82.0 m	HT 23	HT 23	
20	86.5 m		HT 23	
Substructure		KR 12-60 KR 12-60/80	KR 16-80 KR 16-80/100	
Corner distance [m x m]		6.0 x 6.0 8.0 x 8.0	8.0 x 8.0 10.0 x 10.0	
Substructure height [m]		1.4	1.8	
Tower height [m]		83.4	88.3	
Hook height 2 fall operation [m]		84.9	89.8	
Wind category		C 25		

3 Tower combinations

Jib length	52.5 m – 70 m				
Item					
1	4.5 m	UV 20.4	UV 20.4	UV 20.4	UV 20.4
2	9.0 m	UV 20.4	UV 20.4	UV 20.4	UV 20.4
3	13.5 m	UV 20.4	UV 20.4	UV 20.4	UV 20.4
4	18.0 m	UV 20.4	UV 20.4	UV 20.4	UV 20.4
5	22.5 m	UV 20.4	UV 20.4	UV 20.4	UV 20.4
6	27.0 m	UV 20.4	UV 20.4	UV 20.4	UV 20.4
7	31.5 m	UV 20.4	UV 20.4	UV 20.4	UV 20.4
8	36.0 m	UV 20.4	UV 20.4	TVA 20.4	UV 20.4
9	40.5 m	TVA 20.4	TVA 20.4	TV 20.4	TVA 20.4
10	45.0 m	TV 20.4	TV 20.4	TV 20.4	TV 20.4
11	49.5 m	TV 20.4	TV 20.4	TV 20.4	TV 20.4
12	54.0 m	TV 20.4	TV 20.4	TV 20.4	TV 20.4
13	58.5 m	TV 20.4		TV 20.4	TV 20.4
14	63.0 m			TV 20.4	TV 20.4
15	67.5 m			TV 20.4	
Substructure		KR 10-46	KR 10-46/60	KRV 10-60	KRV 10-60
Corner distance [m x m]		4.6 x 4.6	6.0 x 6.0	5.0 x 5.0	6.0 x 6.0
Substructure height [m]		1.2	1.2	1.2	1.2
Tower height [m]		59.7	55.2	68.7	64.2
Hook height 2 fall operation [m]		61.2	56.7	70.2	65.7
Wind category		C 25			

Jib length	52.5 m – 70 m			
Item				
1	4.5 m	UV 20.4		
2	9.0 m	UV 20.4		
3	13.5 m	UV 20.4		
4	18.0 m	UV 20.4		
5	22.5 m	UV 20.4		
6	27.0 m	UV 20.4		
7	31.5 m	UV 20.4		
8	36.0 m	TVA 20.4		
9	40.5 m	TV 20.4		
10	45.0 m	TV 20.4		
11	49.5 m	TV 20.4		
12	54.0 m	TV 20.4		
13	58.5 m	TV 20.4		
14	63.0 m	TV 20.4		
15	64.0 m	VR 2023		
16	68.5 m	TV 23		
Substructure		KRV 10-60		
Corner distance [m x m]		5.0 x 5.0 6.0 x 6.0		
Substructure height [m]		1.2		
Tower height [m]		69.7		
Hook height 2 fall operation [m]		71.2		
Wind category	C 25			

3 Tower combinations

Jib length	52.5 m – 70 m			
Item				
1	4.5 m	UV 20.4		
2	9.0 m	UV 20.4		
3	13.5 m	UV 20.4		
4	18.0 m	UV 20.4		
5	22.5 m	UV 20.4		
6	27.0 m	UV 20.4		
7	31.5 m	UV 20.4		
8	36.0 m	TVA 20.4		
9	40.5 m	TV 20.4		
10	45.0 m	TV 20.4		
11	49.5 m	TV 20.4		
12	54.0 m	TV 20.4		
13	58.5 m	TV 20.4		
14	63.0 m	TV 20.4		
15	67.5 m	TV 20.4		
Substructure		KR 12-60 KR 12-60/80		
Corner distance [m x m]		6.0 x 6.0 8.0 x 8.0		
Substructure height [m]		1.4		
Tower height [m]		68.9		
Hook height 2 fall operation [m]		70.4		
Wind category	C 25			

Jib length	52.5 m – 70 m			
Item				
1	4.5 m	UV 20.4		
2	9.0 m	UV 20.4		
3	13.5 m	UV 20.4		
4	18.0 m	UV 20.4		
5	22.5 m	UV 20.4		
6	27.0 m	UV 20.4		
7	31.5 m	UV 20.4		
8	36.0 m	TVA 20.4		
9	40.5 m	TV 20.4		
10	45.0 m	TV 20.4		
11	49.5 m	TV 20.4		
12	54.0 m	TV 20.4		
13	58.5 m	TV 20.4		
14	63.0 m	TV 20.4		
15	64.0 m	VR 2023		
16	68.5 m	TV 23		
17	73.0 m	HTA 23		
18	77.5 m	HT 23		
Substructure		KR 12-60 KR 12-60/80		
Corner distance [m x m]		6.0 x 6.0 8.0 x 8.0		
Substructure height [m]		1.4		
Tower height [m]		78.9		
Hook height 2 fall operation [m]		80.4		
Wind category	C 25			

3 Tower combinations

Jib length	52.5 m – 70 m			
Item				
1	4.5 m	UV 20.4		
2	9.0 m	UV 20.4		
3	13.5 m	UV 20.4		
4	18.0 m	UV 20.4		
5	22.5 m	UV 20.4		
6	27.0 m	UV 20.4		
7	31.5 m	UV 20.4		
8	36.0 m	TVA 20.4		
9	40.5 m	TV 20.4		
10	45.0 m	TV 20.4		
11	49.5 m	TV 20.4		
12	54.0 m	TV 20.4		
13	58.5 m	TV 20.4		
14	59.5 m	VR 2023		
15	64.0 m	TV 23		
16	68.5 m	TV 23		
17	73.0 m	HTA 23		
18	77.5 m	HT 23		
19	82.0 m	HT 23		
Substructure		KR 16-80 KR 16-80/100		
Corner distance [m x m]		8.0 x 8.0 10.0 x 10.0		
Substructure height [m]		1.8		
Tower height [m]		83.8		
Hook height 2 fall operation [m]		85.3		
Wind category			C 25	

Jib length	52.5 m – 70 m			
Item				
1	4.5 m	UV 20.4		
2	9.0 m	UV 20.4		
3	13.5 m	UV 20.4		
4	18.0 m	UV 20.4		
5	22.5 m	UV 20.4		
6	27.0 m	UV 20.4		
7	31.5 m	UV 20.4		
8	36.0 m	TVA 20.4		
9	40.5 m	TV 20.4		
10	45.0 m	TV 20.4		
11	49.5 m	TV 20.4		
12	54.0 m	TV 20.4		
13	58.5 m	TV 20.4		
14	59.5 m	VR 2023		
15	64.0 m	TV 23		
16	68.5 m	HTA 23		
17	73.0 m	HT 23		
18	77.5 m	HT 23		
19	78.7 m	VR 23/25-29		
20	83.2 m	UV 29		
21	93.2 m	BT 29		
Substructure		KR 16-80 KR 16-80/100		
Corner distance [m x m]		8.0 x 8.0 10.0 x 10.0		
Substructure height [m]		1.8		
Tower height [m]		95.0		
Hook height 2 fall operation [m]		96.5		
Wind category			C 25	

3 Tower combinations

3.3 Tower combinations on cross frame element (slewing section with UV 20 - connection)

Jib length		25 m – 50 m			
Item					
1	4.5 m	UV 20.4	UV 20.4	UV 20.4	
2	9.0 m	UV 20.4	UV 20.4	UV 20.4	
3	13.5 m	UV 20.4	UV 20.4	UV 20.4	
4	18.0 m	UV 20.4	UV 20.4	UV 20.4	
5	22.5 m	UV 20.4	UV 20.4	UV 20.4	
6	27.0 m	UV 20.4	UV 20.4	UV 20.4	
7	31.5 m	UV 20.4	UV 20.4	UV 20.4	
8	36.0 m	UV 20.4	UV 20.4	TVA 20.4	
9	40.5 m	TVA 20.4	TVA 20.4	TV 20.4	
10	45.0 m		TV 20.4	TV 20.4	
11	49.5 m		TV 20.4	TV 20.4	
12	54.0 m		TV 20.4	TV 20.4	
13	58.5 m			TV 20.4	
14	63.0 m			TVÜ 20.4	
15	67.5 m			UVA 25	
Substructure		KRE 260.2	KRE 260.2	KRE 480	
Corner distance [m x m]		5.0 x 6.79	6.0 x 6.0	8.0 x 8.0	
Substructure height [m]		4.0	4.0	4.0	
Tower height [m]		44.5	58.0	71.5	
Hook height 2 fall operation [m]		46.0	59.5	73.0	
Wind category		C 25			

Jib length	52.5 m – 70 m				
Item					
1	4.5 m	UV 20.4	UV 20.4	UV 20.4	
2	9.0 m	UV 20.4	UV 20.4	UV 20.4	
3	13.5 m	UV 20.4	UV 20.4	UV 20.4	
4	18.0 m	UV 20.4	UV 20.4	UV 20.4	
5	22.5 m	UV 20.4	UV 20.4	UV 20.4	
6	27.0 m	UV 20.4	UV 20.4	UV 20.4	
7	31.5 m	UV 20.4	UV 20.4	UV 20.4	
8	36.0 m	UV 20.4	UV 20.4	TVA 20.4	
9	40.5 m	TVA 20.4	TVA 20.4	TV 20.4	
10	45.0 m		TV 20.4	TV 20.4	
11	49.5 m		TV 20.4	TV 20.4	
12	54.0 m		TV 20.4	TV 20.4	
13	58.5 m			TV 20.4	
14	63.0 m			TVÜ 20.4	
15	67.5 m			UVA 25	
Substructure		KRE 260.2	KRE 260.2	KRE 480	
Corner distance [m x m]		5.0 x 6.79	6.0 x 6.0	8.0 x 8.0	
Substructure height [m]		4.0	4.0	4.0	
Tower height [m]		44.5	58.0	71.5	
Hook height 2 fall operation [m]		46.0	59.5	73.0	
Wind category		C 25			

3 Tower combinations

3.4 Tower combinations on city portal (slewing section with UV 20 - connection)

Jib length	25 m – 50 m			
Item				
1	4.5 m	UV 20.4	UV 20.4	
2	9.0 m	UV 20.4	UV 20.4	
3	13.5 m	UV 20.4	UV 20.4	
4	18.0 m	UV 20.4	UV 20.4	
5	22.5 m	UV 20.4	UV 20.4	
6	27.0 m	UV 20.4	UV 20.4	
7	31.5 m	UV 20.4	TVA 20.4	
8	36.0 m	UV 20.4	TV 20.4	
9	40.5 m	TVA 20.4	TV 20.4	
10	45.0 m	TV 20.4	TV 20.4	
11	49.5 m	TV 20.4	TV 20.4	
12	54.0 m		TV 20.4	
13	58.5 m		TV 20.4	
14	63.0 m		TV 20.4	
15	64.0 m		VR 2023	
16	68.5 m		TV 23	
17	73.0 m		TV 23	
18	77.5 m		HTA 23	
19	82.0 m		HT 23	
Substructure		CP 520	CP 690	
Corner distance [m x m]		5.24 x 5.24	6.92 x 6.92	
Substructure height [m]		5.8	6.3	
Tower height [m]		55.3	88.3	
Hook height 2 fall operation [m]		56.8	89.8	
Wind category		C 25		

Jib length	52.5 m – 70 m				
Item					
1	4.5 m	UV 20.4	UV 20.4		
2	9.0 m	UV 20.4	UV 20.4		
3	13.5 m	UV 20.4	UV 20.4		
4	18.0 m	UV 20.4	UV 20.4		
5	22.5 m	UV 20.4	UV 20.4		
6	27.0 m	UV 20.4	UV 20.4		
7	31.5 m	UV 20.4	UV 20.4		
8	36.0 m	UV 20.4	TVA 20.4		
9	40.5 m	TVA 20.4	TV 20.4		
10	45.0 m	TV 20.4	TV 20.4		
11	49.5 m	TV 20.4	TV 20.4		
12	54.0 m		TV 20.4		
13	58.5 m		TV 20.4		
14	63.0 m		TV 20.4		
15	64.0 m		VR 2023		
16	68.5 m		TV 23		
17	73.0 m		HTA 23		
18	77.5 m		HT 23		
Substructure		CP 520	CP 690		
Corner distance [m x m]		5.24 x 5.24	6.92 x 6.92		
Substructure height [m]		5.8	6.3		
Tower height [m]		55.3	83.8		
Hook height 2 fall operation [m]		56.8	85.3		
Wind category		C 25			

3 Tower combinations

3.5 Tower combinations on mobile cross frame (slewing section with UV 20 - connection)

Jib length	25 m – 42.5 m				
Item					
1	4.5 m	UV 20.4	UV 20.4	UV 20.4	UV 20.4
2	9.0 m	UV 20.4	UV 20.4	UV 20.4	UV 20.4
3	13.5 m	UV 20.4	UV 20.4	UV 20.4	UV 20.4
4	18.0 m	UV 20.4	UV 20.4	UV 20.4	UV 20.4
5	22.5 m	UV 20.4	UV 20.4	UV 20.4	UV 20.4
6	27.0 m	UV 20.4	UV 20.4	UV 20.4	UV 20.4
7	31.5 m	UV 20.4	UV 20.4	TVA 20.4	TVA 20.4
8	36.0 m	UV 20.4	TVA 20.4	TV 20.4	TV 20.4
9	40.5 m		TV 20.4	TV 20.4	TV 20.4
10	45.0 m		TV 20.4	TV 20.4	TV 20.4
11	49.5 m		TV 20.4	TV 20.4	TV 20.4
12	54.0 m		TV 20.4	TV 20.4	TV 20.4
13	58.5 m		TV 20.4	TV 20.4	TV 20.4
14	63.0 m			TV 20.4	TV 20.4
15	67.5 m			TV 20.4	TV 20.4
16	68.5 m				VR 2023
17	73.0 m				TV 23
Substructure		KRF 10-46/60	KRF 10-46/60	KRF4 12-60/80	KRF4 12-60/80
Corner distance [m x m]		6.0 x 6.0	6.0 x 6.0	8.0 x 8.0	8.0 x 8.0
Substructure height [m]		2.0	2.0	2.5	2.5
Tower height [m]		38.0	60.5	70.0	75.5
Hook height 2 fall operation [m]		39.5	62.0	71.5	77.0
Wind category		C 25			

3 Tower combinations

Jib length	45 m – 57.5 m				
Item					
1	4.5 m	UV 20.4	UV 20.4	UV 20.4	UV 20.4
2	9.0 m	UV 20.4	UV 20.4	UV 20.4	UV 20.4
3	13.5 m	UV 20.4	UV 20.4	UV 20.4	UV 20.4
4	18.0 m	UV 20.4	UV 20.4	UV 20.4	UV 20.4
5	22.5 m	UV 20.4	UV 20.4	UV 20.4	UV 20.4
6	27.0 m	UV 20.4	UV 20.4	UV 20.4	UV 20.4
7	31.5 m	UV 20.4	UV 20.4	TVA 20.4	TVA 20.4
8	36.0 m	UV 20.4	TVA 20.4	TV 20.4	TV 20.4
9	40.5 m		TV 20.4	TV 20.4	TV 20.4
10	45.0 m		TV 20.4	TV 20.4	TV 20.4
11	49.5 m		TV 20.4	TV 20.4	TV 20.4
12	54.0 m		TV 20.4	TV 20.4	TV 20.4
13	58.5 m		TV 20.4	TV 20.4	TV 20.4
14	63.0 m			TV 20.4	TV 20.4
15	67.5 m			TV 20.4	TV 20.4
16	68.5 m				VR 2023
Substructure		KRF 10-46/60	KRF 10-46/60	KRF4 12-60/80	KRF4 12-60/80
Corner distance [m x m]		6.0 x 6.0	6.0 x 6.0	8.0 x 8.0	8.0 x 8.0
Substructure height [m]		2.0	2.0	2.5	2.5
Tower height [m]		38.0	60.5	70.0	71.0
Hook height 2 fall operation [m]		39.5	62.0	71.5	72.5
Wind category		C 25			

Jib length	45 m – 57.5 m				
Item					
1	4.5 m	UV 20.4			
2	9.0 m	UV 20.4			
3	13.5 m	UV 20.4			
4	18.0 m	UV 20.4			
5	22.5 m	UV 20.4			
6	27.0 m	UV 20.4			
7	31.5 m	TVA 20.4			
8	36.0 m	TV 20.4			
9	40.5 m	TV 20.4			
10	45.0 m	TV 20.4			
11	49.5 m	TV 20.4			
12	54.0 m	TV 20.4			
13	58.5 m	TV 20.4			
14	63.0 m	TV 20.4			
15	67.5 m	TV 20.4			
Substructure		KRF6 12-60/80			
Corner distance [m x m]		8.0 x 8.0			
Substructure height [m]		2.9			
Tower height [m]		70.4			
Hook height 2 fall operation [m]		71.9			
Wind category					C 25

3 Tower combinations

Jib length	45 m – 57.5 m				
Item					
1	4.5 m	UV 20.4			
2	9.0 m	UV 20.4			
3	13.5 m	UV 20.4			
4	18.0 m	UV 20.4			
5	22.5 m	UV 20.4			
6	27.0 m	UV 20.4			
7	31.5 m	TVA 20.4			
8	36.0 m	TV 20.4			
9	40.5 m	TV 20.4			
10	45.0 m	TV 20.4			
11	49.5 m	TV 20.4			
12	54.0 m	TV 20.4			
13	58.5 m	TV 20.4			
14	63.0 m	TV 20.4			
15	64.0 m	VR 2023			
16	68.5 m	TV 23			
17	73.0 m	TV 23			
18	77.5 m	HTA 23			
Substructure		KRF6 12-60/80			
Corner distance [m x m]		8.0 x 8.0			
Substructure height [m]		2.9			
Tower height [m]		80.4			
Hook height 2 fall operation [m]		81.9			
Wind category					C 25

3 Tower combinations

Jib length	60 m – 70 m				
Item					
1	4.5 m	UV 20.4	UV 20.4	UV 20.4	
2	9.0 m	UV 20.4	UV 20.4	UV 20.4	
3	13.5 m	UV 20.4	UV 20.4	UV 20.4	
4	18.0 m	UV 20.4	UV 20.4	UV 20.4	
5	22.5 m	UV 20.4	UV 20.4	UV 20.4	
6	27.0 m	UV 20.4	UV 20.4	UV 20.4	
7	31.5 m	UV 20.4	UV 20.4	TVA 20.4	
8	36.0 m	UV 20.4	TVA 20.4	TV 20.4	
9	40.5 m		TV 20.4	TV 20.4	
10	45.0 m		TV 20.4	TV 20.4	
11	49.5 m		TV 20.4	TV 20.4	
12	54.0 m		TV 20.4	TV 20.4	
13	58.5 m			TV 20.4	
14	63.0 m			TV 20.4	
15	67.5 m			TV 20.4	
Substructure		KRF 10-46/60	KRF 10-46/60	KRF4 12-60/80	
Corner distance [m x m]		6.0 x 6.0	6.0 x 6.0	8.0 x 8.0	
Substructure height [m]		2.0	2.0	2.5	
Tower height [m]		38.0	56.0	70.0	
Hook height 2 fall operation [m]		39.5	57.5	71.5	
Wind category		C 25			

3 Tower combinations

Jib length	60 m – 70 m			
Item				
1	4.5 m	UV 20.4		
2	9.0 m	UV 20.4		
3	13.5 m	UV 20.4		
4	18.0 m	UV 20.4		
5	22.5 m	UV 20.4		
6	27.0 m	UV 20.4		
7	31.5 m	TVA 20.4		
8	36.0 m	TV 20.4		
9	40.5 m	TV 20.4		
10	45.0 m	TV 20.4		
11	49.5 m	TV 20.4		
12	54.0 m	TV 20.4		
13	58.5 m	TV 20.4		
14	63.0 m	TV 20.4		
15	67.5 m	TV 20.4		
Substructure		KRF6 12-60/80		
Corner distance [m x m]		8.0 x 8.0		
Substructure height [m]		2.9		
Tower height [m]		70.4		
Hook height 2 fall operation [m]		71.9		
Wind category		C 25		

Jib length	60 m – 70 m				
Item					
1	4.5 m	UV 20.4			
2	9.0 m	UV 20.4			
3	13.5 m	UV 20.4			
4	18.0 m	UV 20.4			
5	22.5 m	UV 20.4			
6	27.0 m	UV 20.4			
7	31.5 m	TVA 20.4			
8	36.0 m	TV 20.4			
9	40.5 m	TV 20.4			
10	45.0 m	TV 20.4			
11	49.5 m	TV 20.4			
12	54.0 m	TV 20.4			
13	58.5 m	TV 20.4			
14	63.0 m	TV 20.4			
15	64.0 m	VR 2023			
16	68.5 m	TV 23			
17	73.0 m	HTA 23			
18	77.5 m	HT 23			
Substructure	KRF6 12-60/80				
Corner distance [m x m]	8.0 x 8.0				
Substructure height [m]	2.9				
Tower height [m]	80.4				
Hook height 2 fall operation [m]	81.9				
Wind category	C 25				

3 Tower combinations

3.6 Tower combinations on undercarriage (slewing section with UV 20 - connection)



Jib length	25 m – 42.5 m				
Item					
1	4.5 m	UV 20.4	UV 20.4	UV 20.4	UV 20.4
2	9.0 m	UV 20.4	UV 20.4	UV 20.4	UV 20.4
3	13.5 m	UV 20.4	UV 20.4	UV 20.4	UV 20.4
4	18.0 m	UV 20.4	UV 20.4	UV 20.4	UV 20.4
5	22.5 m	TVA 20.4	UV 20.4	UV 20.4	UV 20.4
6	27.0 m		UV 20.4	UV 20.4	UV 20.4
7	31.5 m		UV 20.4	UV 20.4	TVA 20.4
8	36.0 m		UV 20.4	TVA 20.4	TV 20.4
9	40.5 m		TVA 20.4	TV 20.4	TV 20.4
10	45.0 m			TV 20.4	TV 20.4
11	49.5 m			TV 20.4	TV 20.4
12	54.0 m			TV 20.4	TV 20.4
13	58.5 m				TV 20.4
14	63.0 m				TV 20.4
15	67.5 m				TVÜ 20.4
16	72.0 m				UVA 25
Substructure		UW 260.2	UW 260.3	UW 260.3	UW 480
Corner distance [m x m]		6.0 x 6.0	5.0 x 6.79	6.0 x 6.0	8.0 x 8.0
Substructure height [m]		4.5	4.5	4.5	5.0
Tower height [m]		27.0	45.0	58.5	77.0
Hook height 2 fall operation [m]		28.5	46.5	60.0	78.5
Wind category		C 25			

Jib length	45 m – 57.5 m				
Item					
1	4.5 m	UV 20.4	UV 20.4	UV 20.4	UV 20.4
2	9.0 m	UV 20.4	UV 20.4	UV 20.4	UV 20.4
3	13.5 m	UV 20.4	UV 20.4	UV 20.4	UV 20.4
4	18.0 m	UV 20.4	UV 20.4	UV 20.4	UV 20.4
5	22.5 m	TVA 20.4	UV 20.4	UV 20.4	UV 20.4
6	27.0 m		UV 20.4	UV 20.4	UV 20.4
7	31.5 m		UV 20.4	UV 20.4	TVA 20.4
8	36.0 m		UV 20.4	TVA 20.4	TV 20.4
9	40.5 m		TVA 20.4	TV 20.4	TV 20.4
10	45.0 m			TV 20.4	TV 20.4
11	49.5 m			TV 20.4	TV 20.4
12	54.0 m			TV 20.4	TV 20.4
13	58.5 m				TV 20.4
14	63.0 m				TVÜ 20.4
15	67.5 m				UVA 25
Substructure		UW 260.2	UW 260.3	UW 260.3	UW 480
Corner distance [m x m]		6.0 x 6.0	5.0 x 6.79	6.0 x 6.0	8.0 x 8.0
Substructure height [m]		4.5	4.5	4.5	5.0
Tower height [m]		27.0	45.0	58.5	72.5
Hook height 2 fall operation [m]		28.5	46.5	60.0	74.0
Wind category		C 25			

3 Tower combinations

Jib length	60 m – 70 m				
Item					
1	4.5 m	UV 20.4	UV 20.4	UV 20.4	UV 20.4
2	9.0 m	UV 20.4	UV 20.4	UV 20.4	UV 20.4
3	13.5 m	UV 20.4	UV 20.4	UV 20.4	UV 20.4
4	18.0 m	UV 20.4	UV 20.4	UV 20.4	UV 20.4
5	22.5 m	TVA 20.4	UV 20.4	UV 20.4	UV 20.4
6	27.0 m		UV 20.4	UV 20.4	UV 20.4
7	31.5 m		UV 20.4	UV 20.4	UV 20.4
8	36.0 m		UV 20.4	TVA 20.4	TVA 20.4
9	40.5 m		TVA 20.4	TV 20.4	TV 20.4
10	45.0 m			TV 20.4	TV 20.4
11	49.5 m			TV 20.4	TV 20.4
12	54.0 m				TV 20.4
13	58.5 m				TVÜ 20.4
14	63.0 m				UVA 25
Substructure		UW 260.2	UW 260.3	UW 260.3	UW 480
Corner distance [m x m]		6.0 x 6.0	5.0 x 6.79	6.0 x 6.0	8.0 x 8.0
Substructure height [m]		4.5	4.5	4.5	5.0
Tower height [m]		27.0	45.0	54.0	68.0
Hook height 2 fall operation [m]		28.5	46.5	55.5	69.5
Wind category		C 25			

4 Foundation loads / central ballast weights / corner loads in compliance with EN 14439 / EN 13001

	<p style="text-align: center;">! DANGER</p> <p>Usage of incorrect tower combinations. The slewing tower crane may overturn.</p> <ol style="list-style-type: none"> 1) Use the specified tower combinations. 2) If you need another tower combination that is not specified here, please contact WOLFFKRAN to get an approved alternative setup in writing.
	<p style="text-align: center;">NOTICE</p> <p>If you need foundation loads for tower combination with tower element TV 25 and UV 25, please contact WOLFFKRAN to get an approved alternative setup.</p>

Jib positions

The corner loads are given for two jib positions with the maximum corner load resulting from jib position 1.

For square setup, the following equation is true: $a = b$

For rectangular setup, the following equation is true: $a > b$

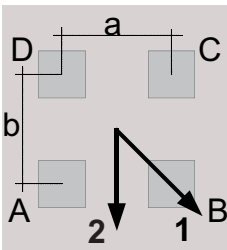

Cross frame or cross frame element

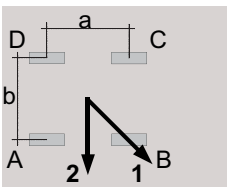

Undercarriage

NOTICE! For undercarriage details, please refer to the relevant operating manual.

Wind load with crane out of service

The stability for stormy weather is calculated on the basis of wind region C (EN 13001-2). The reference wind speed for zone C is 28 m/s (10 m above ground, averaged over 10 minutes). As a basis, a recurrence interval of 25 years is used. As a basis, a recurrence interval of 25 years is used.

4 Foundation loads / central ballast weights / corner loads in compliance with EN 14439 / EN 13001

Please contact WOLFFKRAN for stability calculations in other wind regions.

	NOTICE
	The 4 fall hook height is only for the crane 7032.12 <i>clear</i> in 4 fall operation.

For information on the different substructures, refer to Section 5 of the Operating Manual.

4.1 Foundation loads jib 25 m - 50 m

Slewing section 7032 *clear* with 25 m – 50 m jib on foundation.
Slewing tower crane without climbing device.

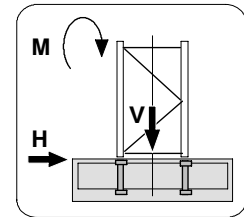

Foundation load in compliance with EN 14439 / EN 13001 – typical loads

Includes all dynamical factors under consideration of second-order theory for stationary slewing tower cranes on concrete foundation in compliance with a tower combination without climbing device.

HH		Crane in service			Crane out of service			Assembly		
4	2	Slewing torque: 360 kNm			Wind category C25			M	V	H
STR	STR	M	V	H	M	V	H	M	V	H
[m]	[m]	[kNm]	[kN]	[kN]	[kNm]	[kN]	[kN]	[kNm]	[kN]	[kN]
5.6	6.0	2280	473	21	2070	473	35	1860	299	7
10.1	10.5	2380	502	23	2250	502	41	1890	328	8
14.6	15.0	2490	530	25	2450	530	47	1930	356	9
19.1	19.5	2620	558	27	2680	558	53	1980	384	10
23.6	24.0	2830	680	30	2950	587	59	2030	412	11
28.1	28.5	3000	698	32	3250	615	65	2090	441	12
32.6	33.0	3200	716	33	3590	643	72	2160	469	13
37.1	37.5	3420	734	35	3970	672	78	2230	497	14
41.6	42.0	3660	753	36	4380	700	84	2320	526	15
46.1	46.5	3860	791	39	4830	728	90	2410	554	16
50.6	51.0	4150	900	44	5330	756	96	2510	582	18
55.1	55.5	4450	928	46	5880	785	102	2630	611	19
59.6	60.0	4850	1038	48	6480	813	109	2750	639	20
64.1	64.5	5240	1066	50	7140	841	115	2890	667	21
68.6	69.0	5670	1095	52	7930	964	172	3030	695	22
73.1	73.5	5980	1052	51	8210	922	169	3080	653	21
74.1	74.5	5890	1106	53	8390	976	176	3080	707	22
78.6	79.0	6280	1145	55	9580	1015	188	3220	746	24
83.1	83.5	6710	1185	57	10880	1055	200	3370	786	25
87.6	88.0	7170	1224	60	12300	1094	212	3530	825	26
89.9	90.3	7340	1259	61	12940	1129	219	3600	860	27
94.4	94.8	7850	1298	63	14530	1168	231	3780	899	28
Tower combination with base tower element BT 29										
94.3	94.7	7600	1323	64	14240	1193	234	3730	924	29
98.8	99.2	8070	1369	66	15860	1239	247	3900	970	30
103.3	103.7	8580	1415	69	17620	1285	261	4090	1016	31

Caption:

HH:	Hook height	V:	Vertical load	STR:	Number of falls
H:	Horizontal load	M:	Torque		

4.2 Foundation loads jib 52.5 m - 70 m

Slewing section 7032 *clear* with 52.5 m – 70 m jib on foundation.
Slewing tower crane without climbing device.

Foundation load in compliance with EN 14439 / EN 13001 – typical loads

Includes all dynamical factors under consideration of second-order theory for stationary slewing tower cranes on concrete foundation in compliance with a tower combination without climbing device.

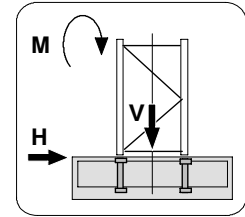



HH		Crane in service			Crane out of service			Assembly		
4	2	Slewing torque: 360 kNm			Wind category C25			M	V	H
STR	STR	M	V	H	M	V	H	M	V	H
[m]	[m]	[kNm]	[kN]	[kN]	[kNm]	[kN]	[kN]	[kNm]	[kN]	[kN]
5.6	6.0	2210	690	25	1470	602	38	2390	326	7
10.1	10.5	2330	708	26	1660	631	44	2430	355	8
14.6	15.0	2470	727	28	1880	659	50	2470	383	9
19.1	19.5	2620	745	29	2130	687	56	2520	411	10
23.6	24.0	2790	763	31	2410	716	63	2580	439	11
28.1	28.5	2980	781	32	2730	744	69	2640	468	13
32.6	33.0	3190	799	34	3080	772	75	2720	496	14
37.1	37.5	3420	818	35	3470	800	81	2800	524	15
41.6	42.0	3680	836	37	3910	829	87	2890	553	16
46.1	46.5	3890	855	43	4390	857	93	3000	581	17
50.6	51.0	4170	983	45	4910	885	100	3110	609	18
55.1	55.5	4490	1012	46	5580	951	145	3230	638	19
59.6	60.0	4840	1040	48	6570	980	155	3370	666	20
64.1	64.5	5230	1068	50	7670	1008	166	3520	694	21
68.6	69.0	5520	1026	49	8020	965	162	3590	652	21
69.6	70.0	5530	1053	51	8180	993	167	3600	679	21
74.1	74.5	5890	1098	53	9320	1037	178	3740	724	23
78.6	79.0	6280	1137	55	10560	1077	190	3890	763	24
83.1	83.5	6700	1177	57	11920	1116	202	4050	802	25
85.4	85.8	6780	1223	59	12460	1162	210	4100	849	26
89.9	90.3	7250	1262	61	14000	1202	222	4280	888	27
Tower combination with base tower element BT 29										
89.8	90.2	7100	1285	62	13890	1225	225	4240	911	28
94.3	94.7	7540	1332	64	15460	1271	239	4420	958	29
98.8	99.2	8010	1378	67	17170	1318	253	4610	1004	31

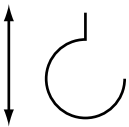
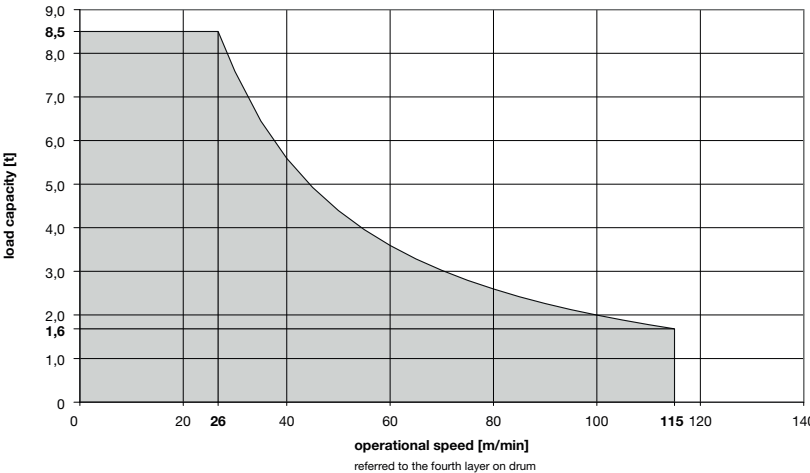
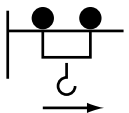
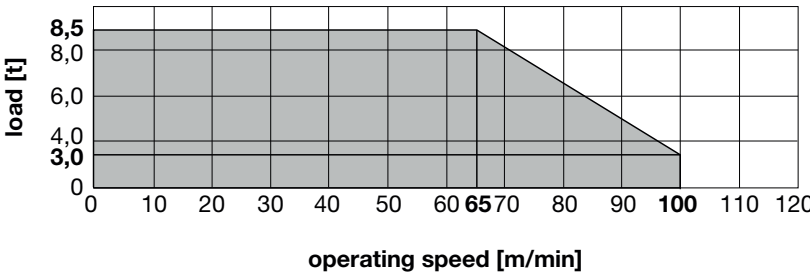

Caption:

HH:	Hook height	V:	Vertical load	STR:	Number of falls
H:	Horizontal load	M:	Torque		

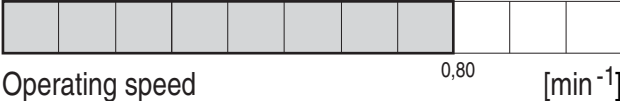
5 Operating speeds



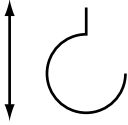
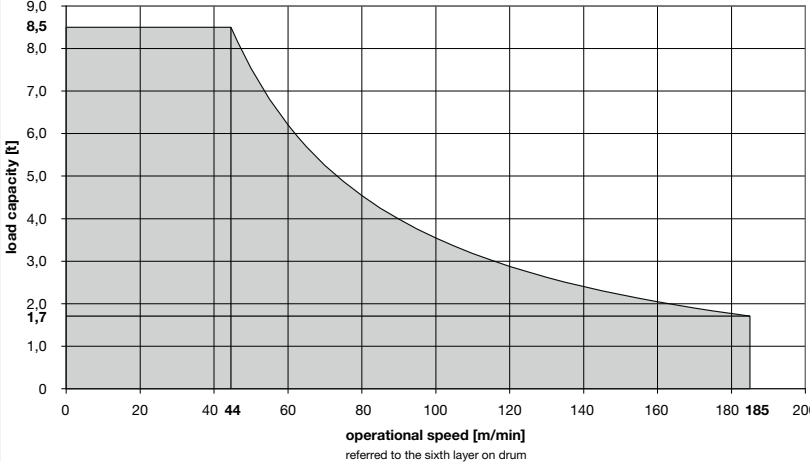
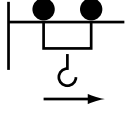
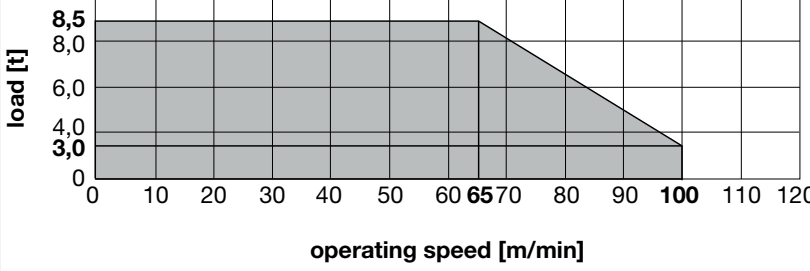

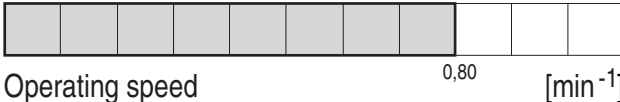





Drive unit [type]	Operating speed Carrying load		Hook travel distance max. [m]	Power [kW]	Total connected load [kVA]
Hw845FU	Lifting		190	45	62.0 Total connected load at coincidence factor of 0.7
					
KW	Trolley movement			7.5	
					
SG	Slewing			1 x 7.5	
					

5 Operating speeds

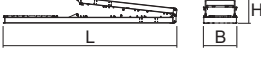

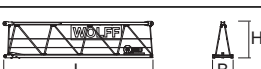
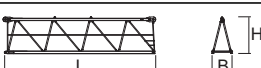

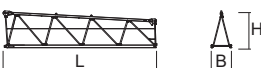

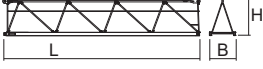
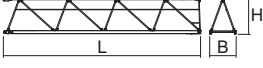
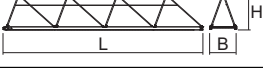

Drive unit [type]	Operating speed Carrying load		Hook travel distance max. [m]	Power [kW]	Total connected load [kVA]
Hw875FU	Lifting		460	75	62.0 Total connected load at coincidence factor of 0.7
	 <p>load capacity [t]</p> <p>operational speed [m/min] referred to the sixth layer on drum</p>				
KW	Trolley movement			7.5	
	 <p>load [t]</p> <p>operating speed [m/min]</p>				
SG	Slewing			1 x 7.5	
	 <p>Operating speed [min⁻¹]</p>				

6 Package list

6.1 Package list 7032.8

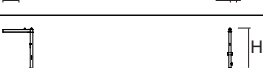
Quantity	Description	Package	L [m]	W [m]	H [m]	Weight [kg]	Volume [m ³]
1	Tower head section complete, with slewing frame, ball race bearing, slewing gear and slip ring system (brace parts for trolley jib and counterjib)		6.63	2.62	2.32	10940 (340)	40.30
1	Tower head section upper part (brace parts for trolley jib and counterjib)		2.23	0.71	2.20	1775 (340)	3.48
1	Tower head section lower part with slewing frame, ball race bearing, slewing gear and slip ring system		5.27	2.62	2.32	9165	32.03
1	Driver's cab station with driver's cab and control cabinet		4.73	2.12	2.56	2625	25.67
1	Counterjib in hinged position without railings and auxiliary crane, incl. brace (brace parts for counterjib)		11.97	2.30	2.22	10340 (1300)	61.12
1	Hoisting gear Hw 845 FU without 2nd brake and hoisting rope (2nd brake) (190 m hoisting rope)		1.69	1.72	1.04	2070 (648) (240)	4.45
1	Hoisting gear Hw 875 FU without 2nd brake and hoisting rope (2nd brake) (190 m hoisting rope)		1.95	1.68	1.23	2235 (648) (240)	4.03
1	Jib element 1		10.30	1.41	2.54	3920	36.89
1	Jib element 2		10.32	1.40	2.50	2380	36.12
1	Jib element 3		5.31	1.40	2.49	1035	18.51
1	Jib element 4		10.26	1.40	2.46	1740	35.34
1	Jib element 5		5.23	1.40	1.92	810	14.06

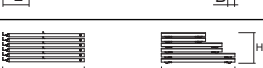
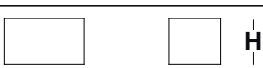
6 Package list

Quantity	Description	Package	L [m]	W [m]	H [m]	Weight [kg]	Volume [m³]
1	Jib element 6		2.73	1.40	1.92	510	7.34
1	Jib element 7		10.22	1.40	1.92	1370	27.47
1	Jib element 8		10.15	1.40	1.91	1000	27.14
1	Jib element 9		10.16	1.40	1.91	760	27.17
1	Rope swivel crossbeam		0.99	1.35	0.43	145	0.58
1	Trolley LK 8		1.87	1.60	0.83	330	2.48
1	Maintenance cage		0.75	0.50	1.70	52	0.64
1	Hook block U 6 (8)		0.50	0.22	1.11	350	0.12
1	Auxiliary crane		2.29	0.41	3.46	235	3.25
7	Counterweight blocks		1.41	0.36	2.30	2700	1.17
1	Standard railings		1.10	2.20	1.00	420	2.42
1	Box (small parts)		0.63	0.50	0.38	100	1.12

7 Assembly weights

7.1 Counterweight blocks



NOTICE

The described diagrams of the concrete counterweights and central ballast blocks only show sketches. Have them issue the reinforcement charts by experts.

7 Assembly weights

7.1.1 Counterweight block, 2.7 t

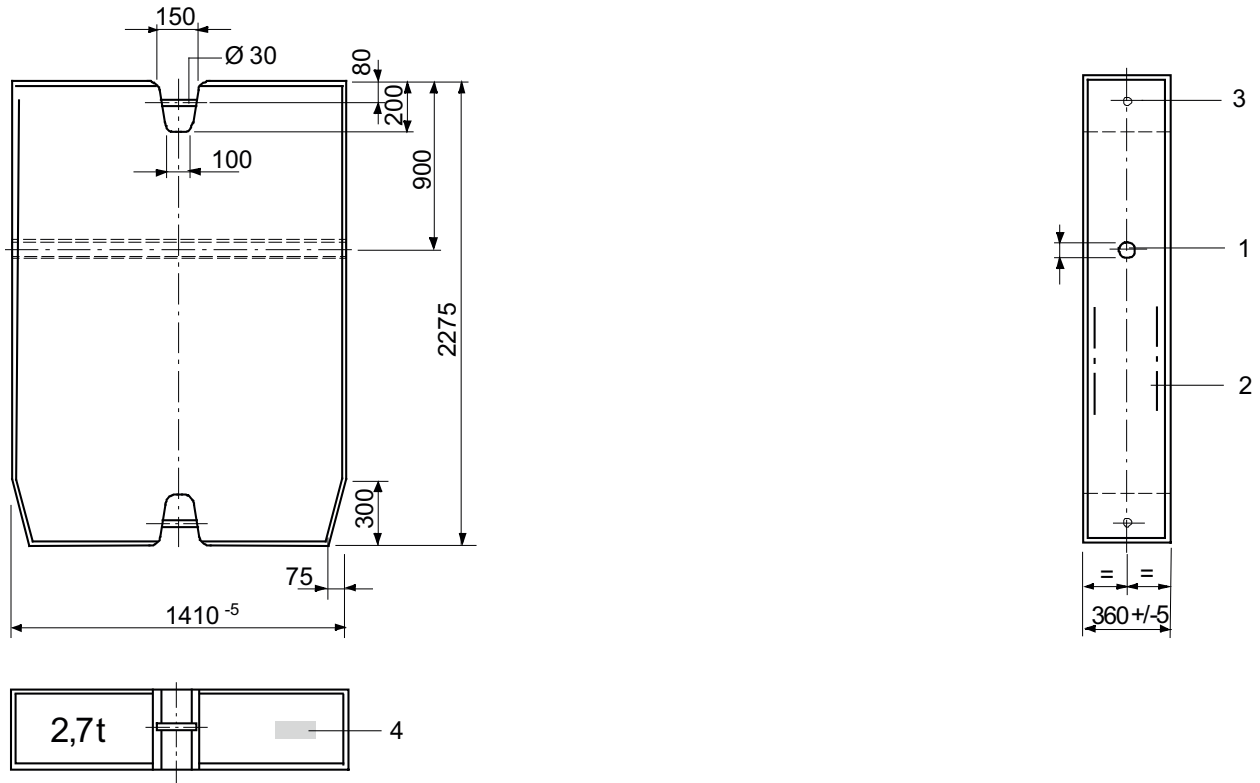

Data counterweight block 2.7 t

Item	Data
Material	Concrete, min. C 20/25
Max. permitted weight tolerance	+/- 3 %
Order number	30021887
1	Connection for stub shaft (Ø 40x 215 Item no.: 30024871)
2	Structural steel reinforcement
3	Suspension
4	Component identifier

7.2 Total weight jib assembly

Trolley jib, complete: trolley, trolley ropes, snatch block and rope swivel crossbeam

Jib length [m]	Weight [kg] WOLFF 7032.8clear
70.0	14050
67.5	13750
65.0	13240
62.5	13180
60.0	13290
57.5	12990
55.0	12480
52.5	12420
50.0	12280
47.5	11980
45.0	11470
42.5	11410
40.0	10900
37.5	10600
35.0	10090
32.5	9560
30.0	9050
27.5	8200
25.0	7690

7 Assembly weights

7.3 Assembly weight slewing section

Module	Crane parts	Weight [kg]
Tower head section, complete with driver's cab and driver's cab suspension		13605
Tower head section, complete		10980
	▪ Upper tower head section	1775
	▪ Slewing frame	5360
	▪ Tower head section lower part	3630
	▪ Ladder and connections to slewing frame	175
	▪ standard railings and standard posts	40
Driver's cab		2625
Counterjib, complete with auxiliary crane, braces, standard railings and platforms		10865
	▪ Counterjib	9040
	▪ Platforms and standard railings	290
	▪ Auxiliary crane	235
	▪ Counter jib brace	1300
Hoist winch frame Hw 845 FU complete with 2nd brake and 190 m hoisting rope		2958
	▪ Hoist winch platform Hw 845 FU	2070
	▪ 2nd brake incl. platform and standard railings	648
	▪ Hoisting rope Ø 16 mm x 190 m	240
Hoist winch frame Hw 875 FU complete with 2nd brake and 190 m hoisting rope		3123
	▪ Hoist winch platform Hw 875 FU	2235
	▪ 2nd brake incl. platform and standard railings	648
	▪ Hoisting rope Ø 16 mm x 190 m	240

7.4 Assembly weight cross frame

Module	Crane parts	Weight [kg]	
Cross frame KR 10-46 (without accessories)			
(4.6 m x 4.6 m)	▪ 4 bolted spigots AZR 120 E 15.5	552	7020
	▪ 4 bolted spigots AZ 140 M	698	
Cross frame KR 16 - 46/ 60 (without accessories)			
(6.0 m x 6.0 m)	▪ 4 bolted spigots AZR 120 E 15.5	552	8875
	▪ 4 bolted spigots AZ 140 M	698	
Cross frame KRV 10-60 (without accessories)			
(6.0 m x 6.0 m)	▪ AZ 140 M KRV 10-60	745	9990
	▪ AZ 120 E 15,5 KRV 10-60	685	
	▪ AZ 140 M for KRV 10-60	745	
	▪ AZ 140 E 10 KRV 10-60	745	
Cross frame KR 12-60 (without accessories)			
(6.0 m x 6.0 m)	▪ AZ 140 M KR 12-60/80	790	15650
	▪ AZ 120 E15,5 KR 12-60/80	730	
	▪ AZ 140 E17 KR 12-60/80	875	
	▪ AZ 160 M KR 12-60/80	905	
	▪ AZ 140 E 10 KR 12-60/80	790	
	▪ AZ 156 M KR 12-60/80	845	
Cross frame KR 12-60/ 80 (without accessories)			
(8.0 m x 8.0 m)	▪ AZ 140 M KR 12-60/80	790	19260
	▪ AZ 120 E15,5 KR 12-60/80	730	
	▪ AZ 140 E17 KR 12-60/80	875	
	▪ AZ 160 M KR 12-60/80	905	
	▪ AZ 140 E 10 KR 12-60/80	790	
	▪ AZ 156 M KR 12-60/80	845	
Cross frame KR 16-80 (without accessories)			
(8.0 m x 8.0 m)	▪ 4 bolted spigots AZ 140 E KR 16-80	620	21450
	▪ 4 bolted spigots AZ 156 M KR 16-80	680	
	▪ 4 bolted spigots AZ 156S M KR 16-80	675	
Cross frame KR 16-80/ 100 (without accessories)			
(10.0 m x 10.0 m)	▪ 4 bolted spigots AZ 140 E KR 16-80	620	25400
	▪ 4 bolted spigots AZ 156 M KR 16-80	680	
	▪ 4 bolted spigots AZ 156S M KR 16-80	675	

7 Assembly weights

7.5 Assembly weights traveling cross frame

Module	Crane parts	Weight [kg]	
Mobile cross frame KRF 10 – 46/60 complete			17500
(6.0 m x 6.0 m)	▪ Cross frame	7000	
	▪ Drive gear corners	2385	
	▪ Backing braces	1510	
	▪ Subframe	5645	
	▪ Platforms + ladders	510	
	▪ Control cabinet	130	
	▪ small items	320	
	▪ Set of bolted spigots AZR 120 E 15,5 KRF 10-46/60	605	
	▪ Set of bolted spigots AZR 140 M KRF 10-46/60	760	
Traveling cross frame KRF4 12-60/80 complete			32300
(8.0 m x 8.0 m)	▪ Cross frame	14170	
	▪ Backing braces	2875	
	▪ Drive gear corners	4560	
	▪ Subframe	9380	
	▪ Platforms and ladders	255	
	▪ Control cabinet	130	
	▪ small items	930	
	▪ Set of bolted spigots AZR 140 M KR 12-60/80	790	
	▪ Set of bolted spigots AZ 120 E 15,5 KR 12-60/80	730	
	▪ Set of bolted spigots AZ 140 E 15,5 KR 12-60/80	875	
	▪ Set of bolted spigots AZR 160 M KR 12-60/80	905	
	▪ Set of bolted spigots AZ 140 E 10 KR 12-60/80	790	
	▪ Set of bolted spigots AZR 156 M KR 12-60/80	845	
Traveling cross frame KRF6 12-60/80 complete			41200
(8.0 m x 8.0 m)	▪ Cross frame	14170	
	▪ Backing braces	2875	
	▪ Drive gear corners	4560	
	▪ Subframe	18270	
	▪ Platforms and ladders	255	
	▪ Control cabinet	130	
	▪ small items	940	
	▪ Set of bolted spigots AZR 140 M KR 12-60/80	790	

Module	Crane parts	Weight [kg]
	▪ Set of bolted spigots AZ 120 E 15,5 KR 12-60/80	730
	▪ Set of bolted spigots AZ 140 E 15,5 KR 12-60/80	875
	▪ Set of bolted spigots AZR 160 M KR 12-60/80	905
	▪ Set of bolted spigots AZ 140 E 10 KR 12-60/80	790
	▪ Set of bolted spigots AZR 156 M KR 12-60/80	845

7 Assembly weights

7.6 Assembly weight cross frame elements

Module	Crane part	Weight [kg]	
Cross frame element KRE 260.2, complete			10 900
	▪ Mast base with diagonal struts and tie rods	5 445	
	▪ Cross frame platform with jibs, corner plates and transport locks	5 455	
Cross frame element KRE 480 complete			24 250
	▪ Mast base	7 100	
	▪ Hinged sections with corner plates	6 250	
	▪ Diagonal struts and ballast carrier	9 260	
	▪ Assembly platform, ladder, and small parts	1 640	

7.7 Assembly weight undercarriage

Module	Crane part	Weight [kg]	
Undercarriage UW 260.2, complete			14 060
	▪ Mast base with diagonal struts and tie rods	4 250	
	▪ Undercarriage platform with hinged sections, subframes and transport locks	9 810	
Undercarriage UW 260.3, complete			17 100
	▪ Mast base with diagonal struts and tie rods	5 880	
	▪ Undercarriage platform with hinged sections, subframes and transport locks	11 220	
Undercarriage UW 480, complete			34 000
	▪ Mast base	7 100	
	▪ Hinged sections with mounting device and subframes	16 000	
	▪ Diagonal struts and ballast carrier	9 260	
	▪ Assembly platform, ladder, and small parts	1 640	

7 Assembly weights

7.8 Assembly weights city portal

Module	Crane parts	Weight [kg]	
City portal CP 520, complete (without bolted spigots)			13335
(5.24 m x 5.24 m)	▪ Cross frame (without accessories)	7000	
	▪ City Portal undercarriage	6335	
	▪ small items	425	
	▪ 4 bolted spigots AZ 120 E 15.5	560	
	▪ 4 bolted spigots AZ 140 M	684	
City portal CP 690, complete (without bolted spigots)			24735
(6.92 m x 6.92 m)	▪ Cross frame (without accessories)	14200	
	▪ City Portal undercarriage	10535	
	▪ small items	325	
	▪ AZ 140 M KR 12-60/80	790	
	▪ AZ 120 E15,5 KR 12-60/80	730	
	▪ AZ 140 E17 KR 12-60/80	875	
	▪ AZ 160 M KR 12-60/80	905	
	▪ AZ 140 E 10 KR 12-60/80	790	
	▪ AZ 156 M KR 12-60/80	845	

7.9 Required hook height for mobile cranes

For information about the height of the WOLFF slewing tower crane, refer to Tower combinations [9].

NOTICE! During assembly, allowances must be made for level differences (mobile crane to base of the slewing tower crane).

Hook height above ground required for mobile cranes (X) = height of the WOLFF slewing tower crane (A) + clearance of 12 m (B).

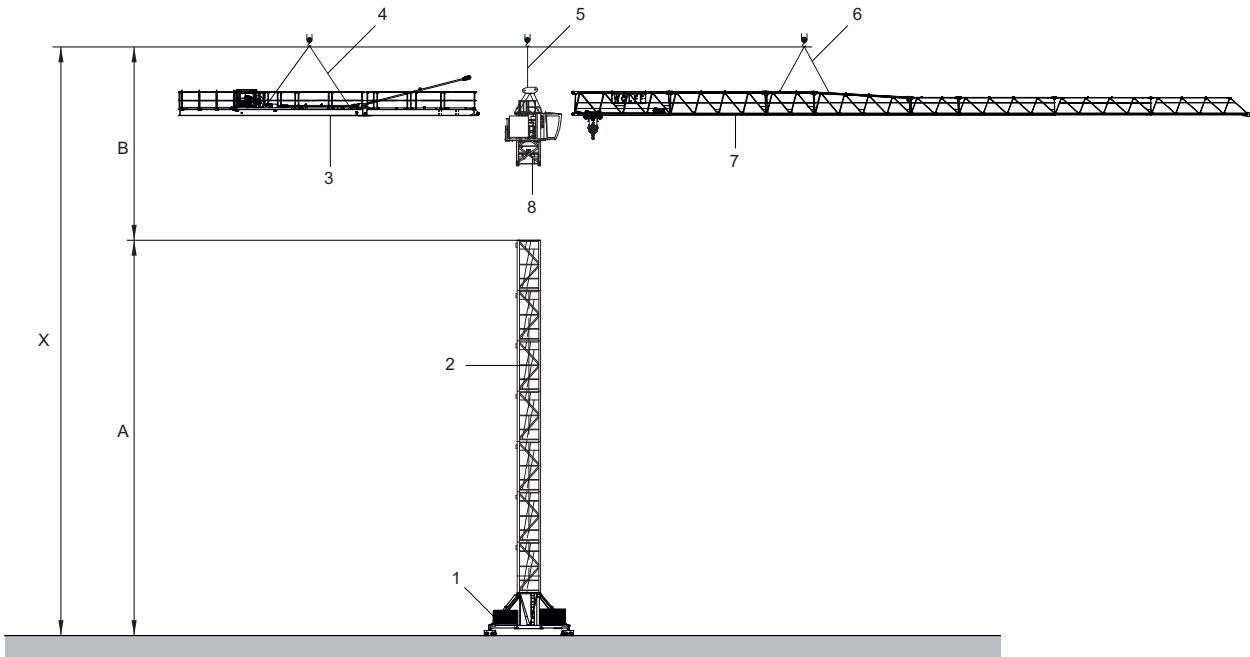

Exemplary illustration

[A]	Height of the WOLFF slewing tower crane	[B]	Clearance 12 m
[X]	Hook height above ground required for the mobile crane		
1	Undercarriage	5	Single-point lifting tackle (2 m with shackle)
2	Tower element	6	4-fall attachment (4 m with shackle)
3	Counterjib, complete	7	Jib, complete
4		8	Tower head section, complete

(see also):

- Tower combinations [9]

8 Assembly diagrams

8 Assembly diagrams

8.1 Jib attachment diagram

	NOTICE
	<p>Use of a wind sail.</p> <p>Use a wind sail for jib lengths of 25 m and 27,5 m. Please contact WOLFFKRAN for information.</p>

	NOTICE
	<p>For jib assembly, use a 4-fall attachment (4 m with shackle).</p>

Length of jib elements

Item	Length [m]
Jib element 1, 2, 4, 7, 8, 9	10.0
Jib element 3, 5	5.0
Jib element 6	2.5

8.1.1 Trolley jib - attachment diagram 70 m to 65 m

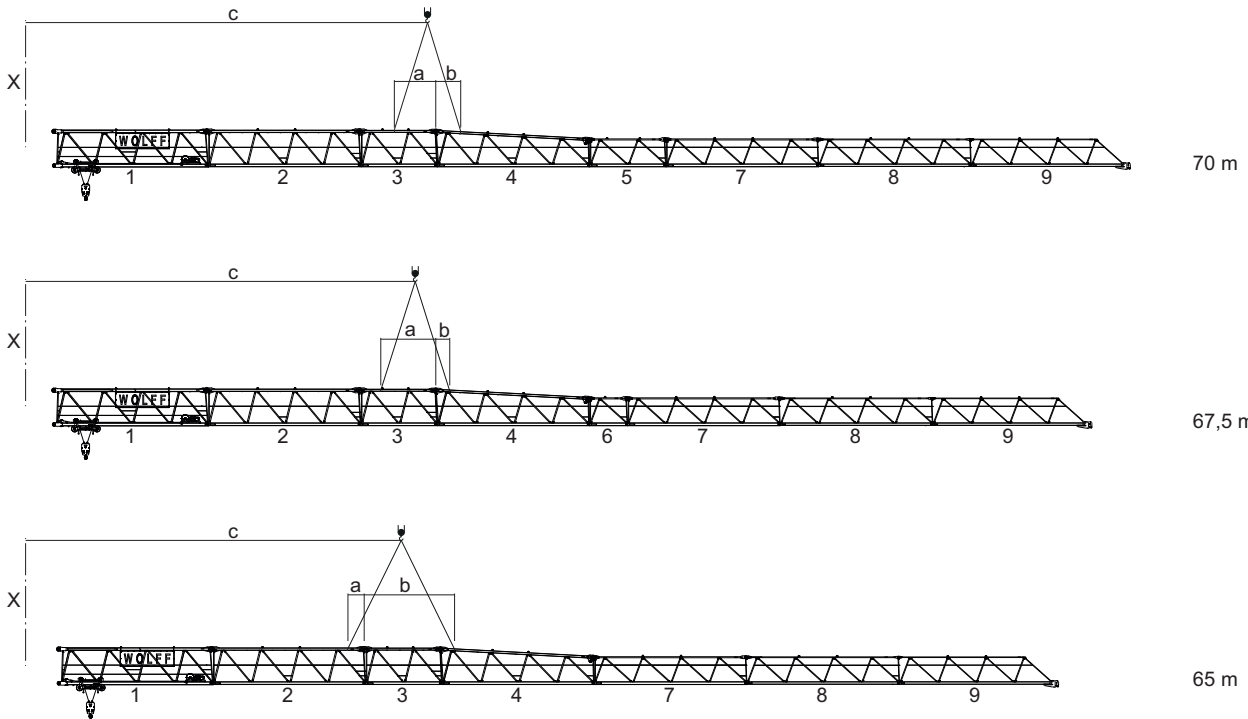

a	Dimension a	b	Dimension b
c	Dimension c	X	Middle of tower

Data	Jib length [m]		
	70	67.5	65
a [m]	2.80	3.68	1.15
b [m]	1.70	0.97	5.97
c [m]	25.52	24.71	23.48
Weight [kg]	13950	13650	13140

8 Assembly diagrams

8.1.2 Trolley jib - attachment diagram 62.5 m to 57.5 m

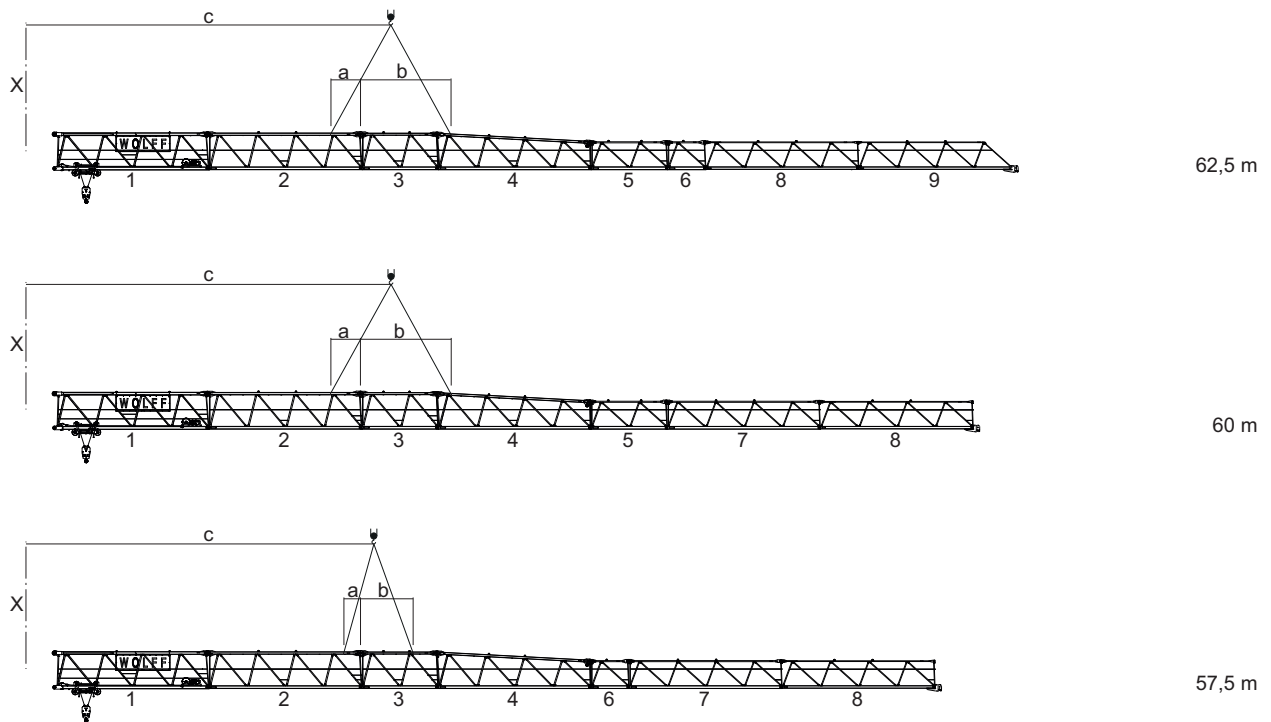

a	Dimension a	b	Dimension b
c	Dimension c	X	Middle of tower

Data	Jib length [m]		
	62.5	60	57.5
a [m]	1.98	1.98	1.15
b [m]	5.97	5.97	3.47
c [m]	23.06	23.06	22.23
Weight [kg]	13080	13190	12890

8.1.3 Trolley jib - attachment diagram 55 m to 50 m

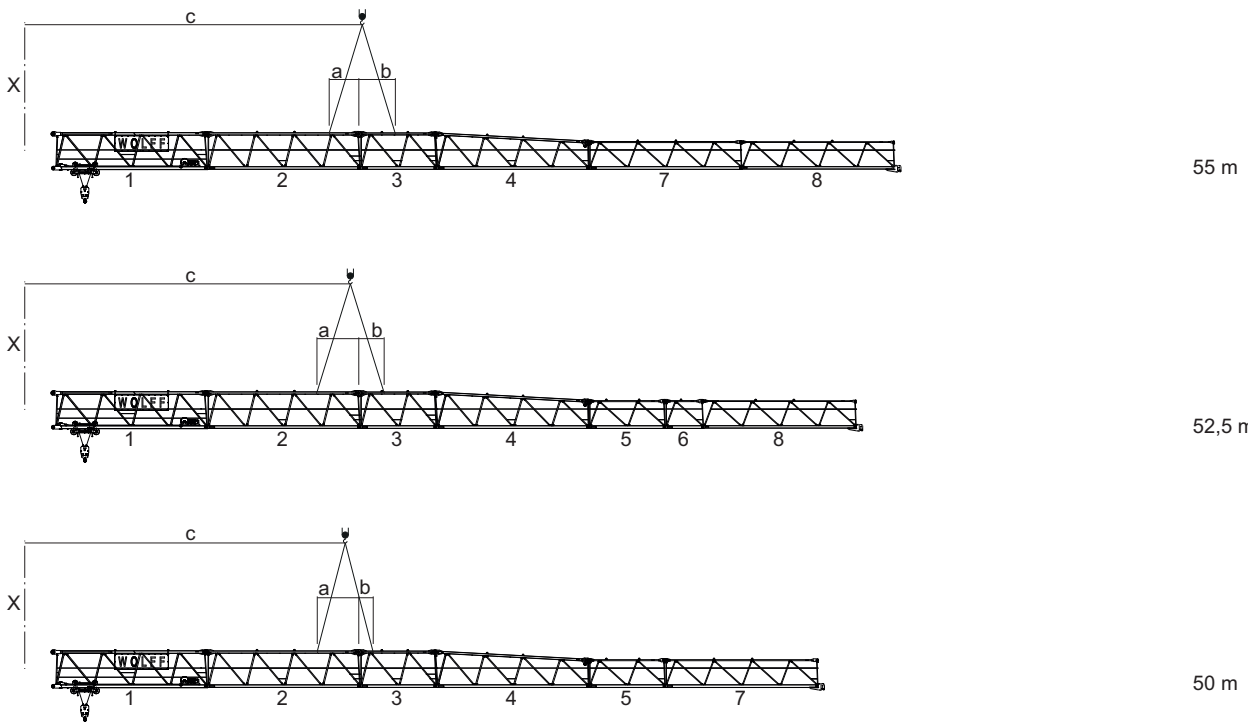

a	Dimension a	b	Dimension b
c	Dimension c	X	Middle of tower

Data	Jib length [m]		
	55	52.5	50
a [m]	1.98	2.80	2.80
b [m]	2.45	1.69	0.97
c [m]	21.30	20.51	20.15
Weight [kg]	12380	12320	12180

8 Assembly diagrams

8.1.4 Trolley jib - attachment diagram 47.5 m to 42.5 m

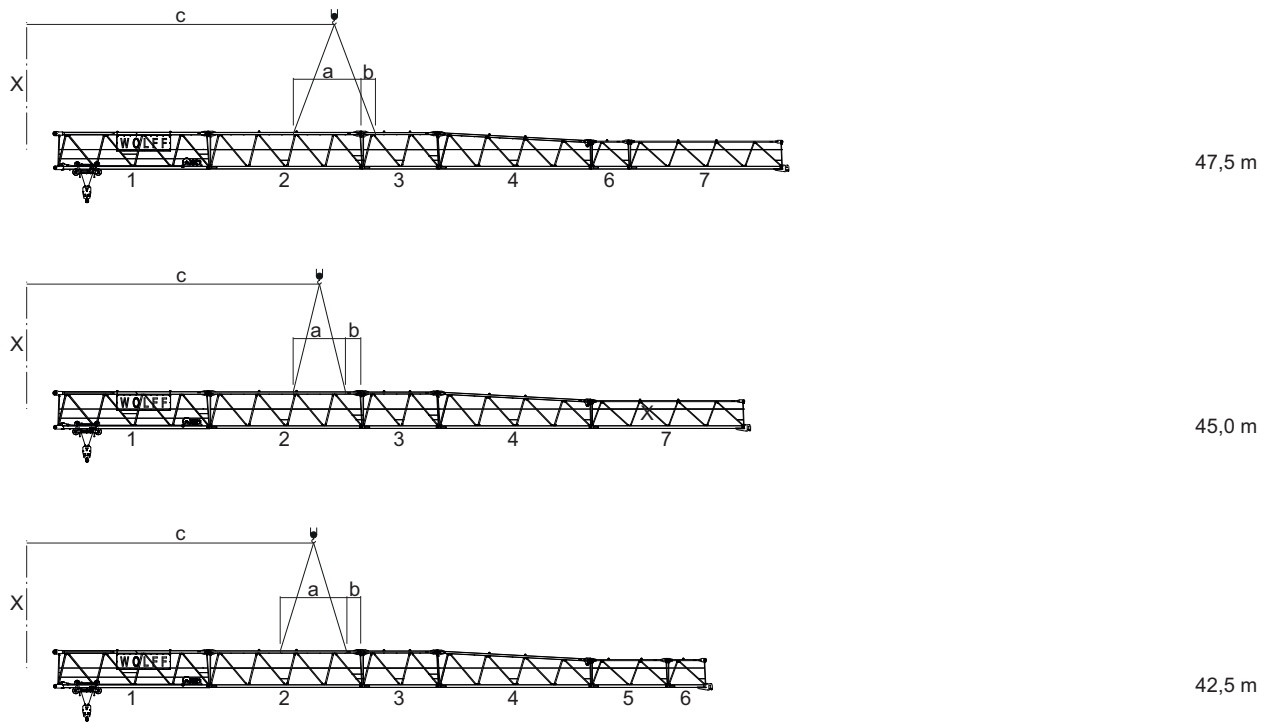

a	Dimension a	b	Dimension b
c	Dimension c	X	Middle of tower

Data	Jib length [m]		
	47.5	45	42.5
a [m]	4.48	3.58	4.40
b [m]	0.97	0.90	0.90
c [m]	19.31	18.38	17.97
Weight [kg]	11880	11370	11310

8.1.5 Trolley jib - attachment diagram 40 m to 35 m

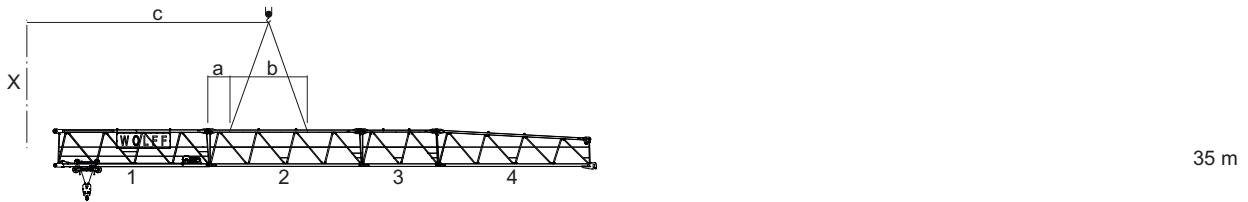
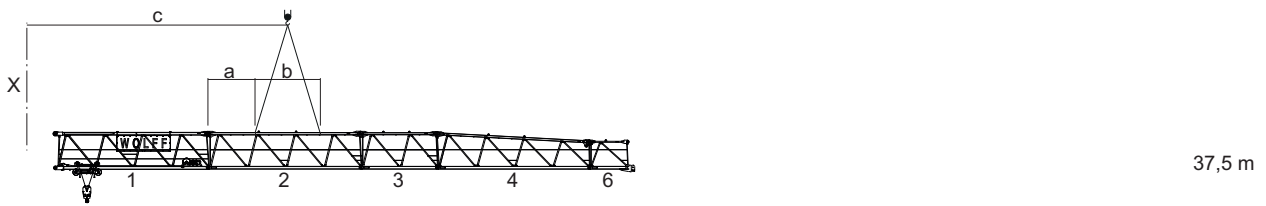
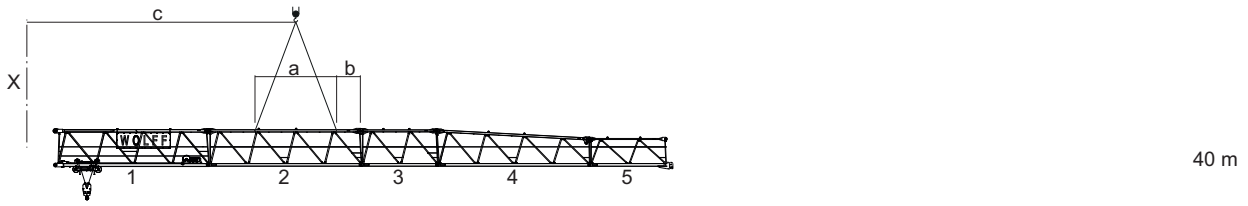

a	Dimension a	b	Dimension b
c	Dimension c	X	Middle of tower

Data	Jib length [m]		
	40	37.5	35
a [m]	5.45	3.02	1.37
b [m]	1.53	4.43	5.25
c [m]	16.81	16.30	15.06
Weight [kg]	10800	10500	9990

8 Assembly diagrams

8.1.6 Trolley jib - attachment diagram 32.5 m to 27.5 m

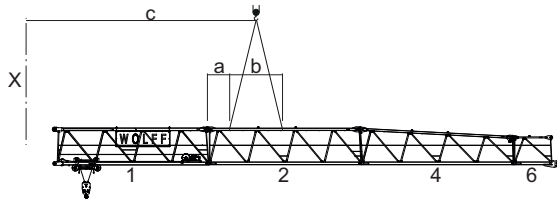

32,5 m

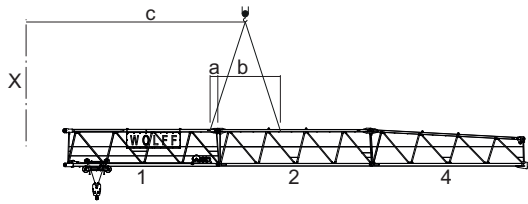

30 m

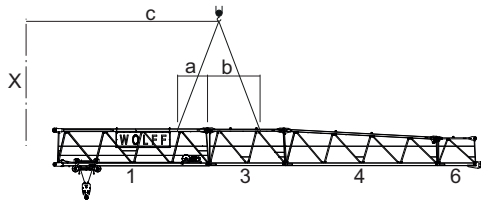

27,5 m

a	Dimension a	b	Dimension b
c	Dimension c	X	Middle of tower

Data	Jib length [m]		
	32.5	30	27.5
a [m]	1.37	0.54	1.98
b [m]	3.58	4.12	3.47
c [m]	14.23	12.86	11.81
Weight [kg]	9460	8950	8100

8.1.7 Trolley jib - attachment diagram 25 m

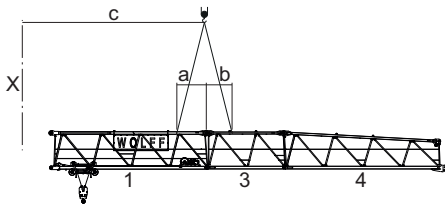

25 m

a	Dimension a	b	Dimension b
c	Dimension c	X	Middle of tower

Data	Jib length [m]		
	25		
a [m]	1.98		
b [m]	1.69		
c [m]	10.92		
Weight [kg]	7590		

8 Assembly diagrams

8.2 Counterjib lifting diagram

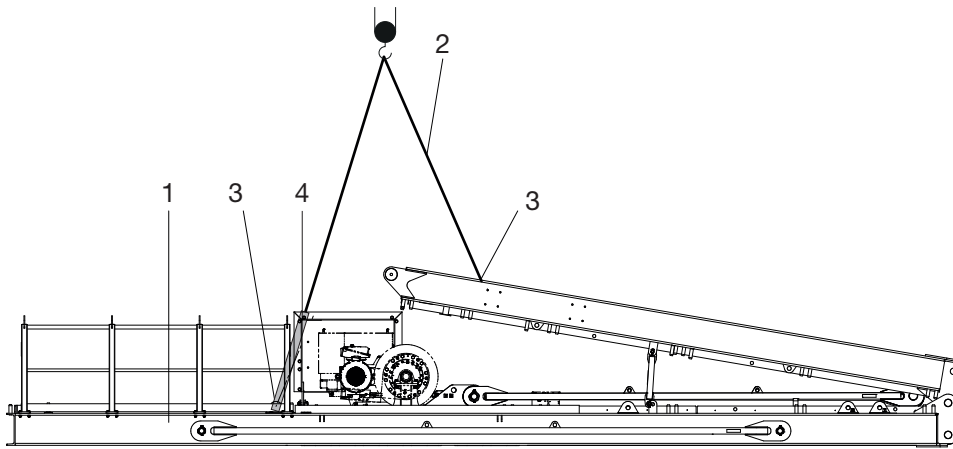

Lifting eyes for transport position marked with "2"

1	Counterjib in hinged position with hoisting gear	3	Lifting eyes
2	Four-fall attachment (4 m with shackle)	4	Attachment extension (attachment rope ; with shackle and sling, order-no.: 10031510)

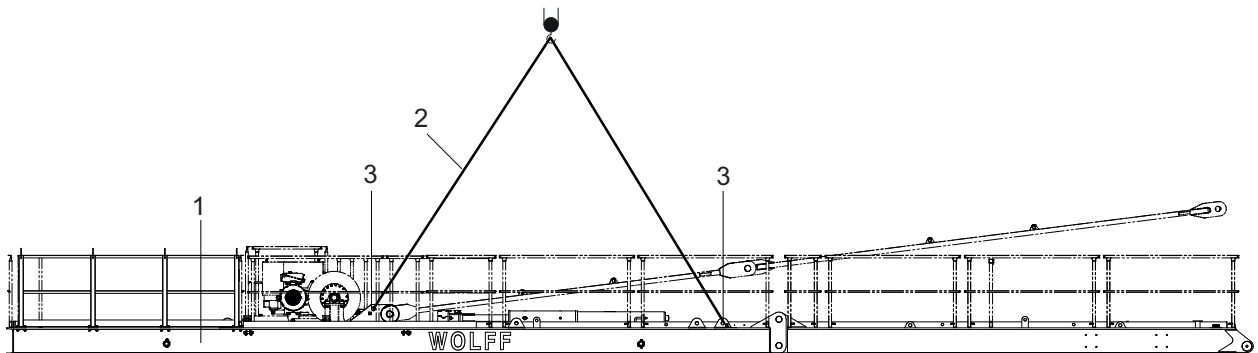

Lifting eyes for up to 500 m hoisting rope on drum marked with "1"

1	Counterjib with hoisting gear	3	Lifting eyes
2	Four-fall attachment (4 m with shackle)		

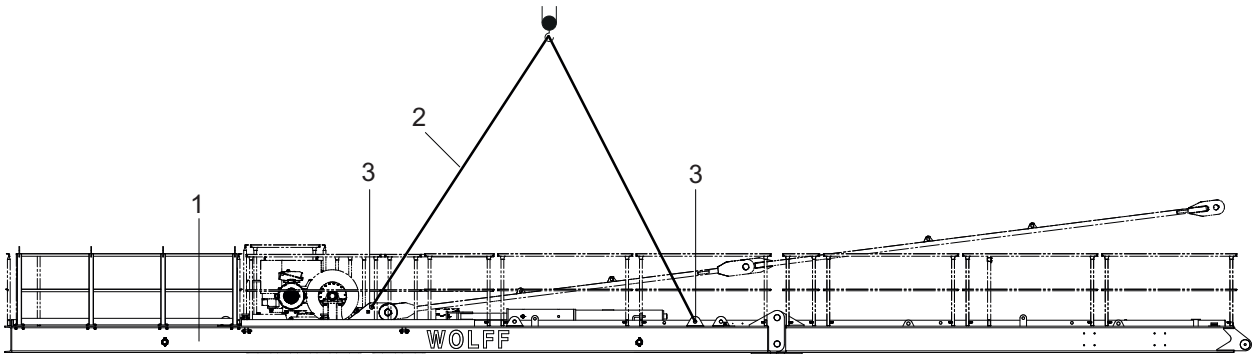

Lifting eyes for more than 500 m hoisting rope on drum marked with "3"

1	Counterjib with hoisting gear	3	Lifting eyes
2	4-fall attachment (4 m with shackle)		

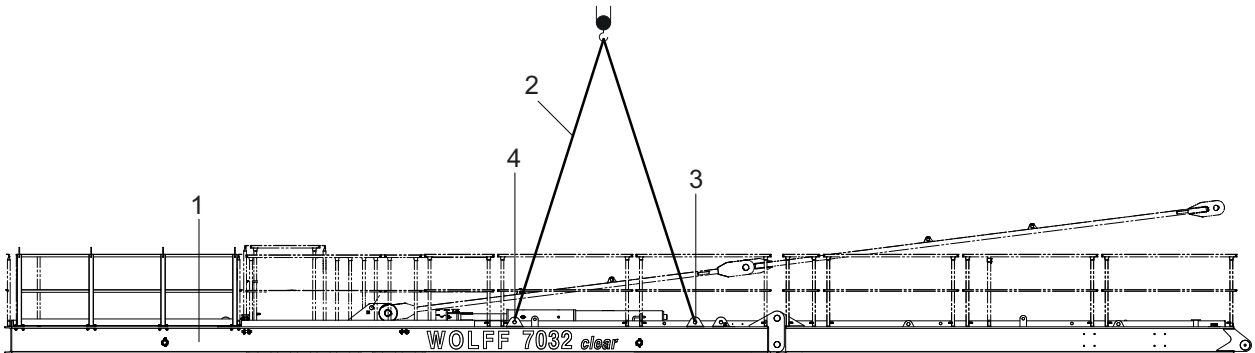

Counterjib lifting diagram: counterjib without mounted hoisting gear

1	Counterjib without hoisting gear	3	Lifting eye marked with "3"
2	Four-fall attachment (4 m with shackle)	4	Lifting eye not marked

8 Assembly diagrams

8.3 Jib brace diagram

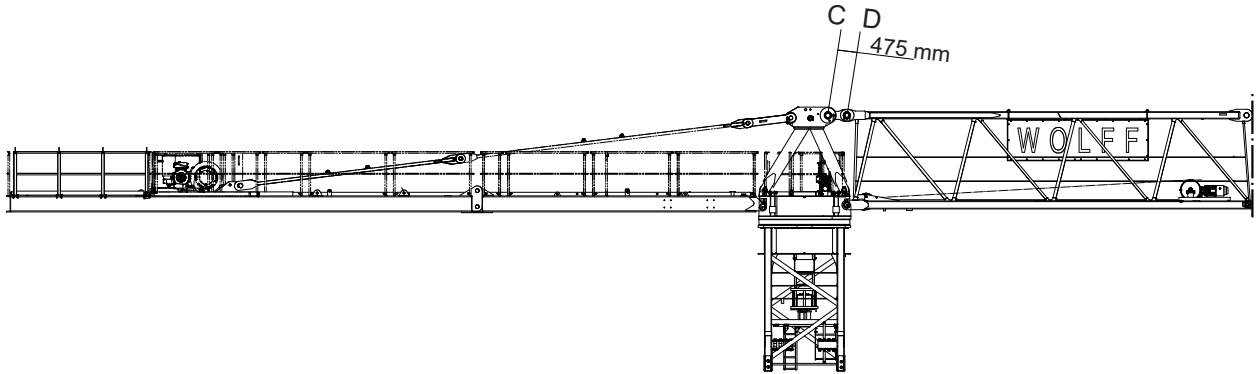

Bolt table

Jib length	Item	Bolts		Fuse	
		Quantity	Dimension [mm]	Quantity	Dimension [mm]
All	C	1	Ø 135 x 610	2	Washer Ø 180 / 136 x 4
				2	Cotter pin 16 x 160
				1	Distance bush Ø 152,4 / 135,2 x 270
	D	1	Ø 120 x 460	2	Washer Ø 180 / 121 x 4
				2	Locking pin 20x150

8.4 Counterjib brace diagram

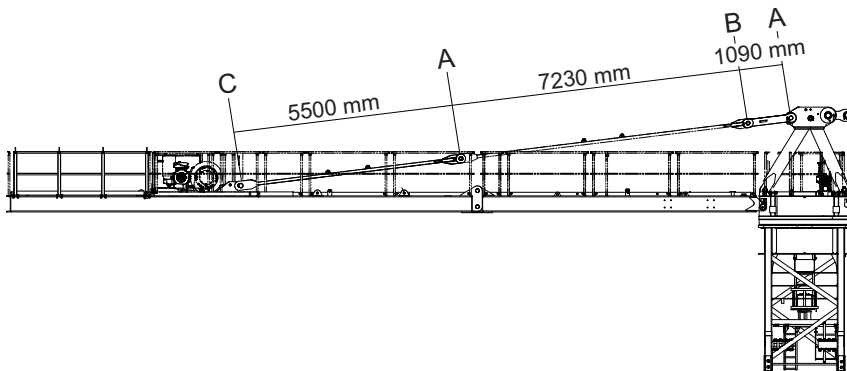

Bolt table

Bolts			Fuse	
Ref.	Quantity	Dimension [mm]	Quantity	Dimension [mm]
A	4	Ø 95 / 80 x 210	4	Locking pin 10 x 100
B	2	Ø 95 / 80 x 210	2	Locking pin 10 x 100
			4	Washer Ø 130 / 81 x 4
C	2	Ø 110 / 90 x 215	2	Locking pin 17 x 125

8 Assembly diagrams

8.5 Trolley jib mounting rig

	NOTICE
	<p>For information on the arrangement of the mounting rig, refer to the attachment diagram.</p> <p>Two mounting rigs are required per slewing tower crane.</p>

Elements required for each mounting rig

Mounting rig

Ref.	Quantity	Item	Dimensions
1	4	Hexagonal head screw	M16x270-8.8 ISO 4017
2	8	Hexagonal nut	M16-8 ISO 4032
3	8	Washer	A16-200HV ISO 7090
4	1	Flange plate	12x210x295

Mounting rig

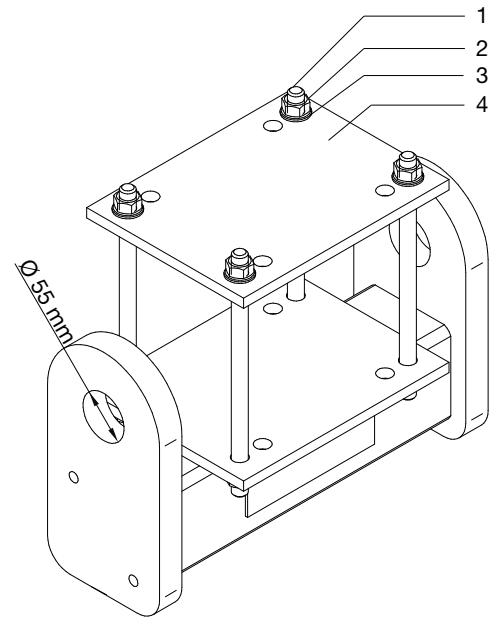
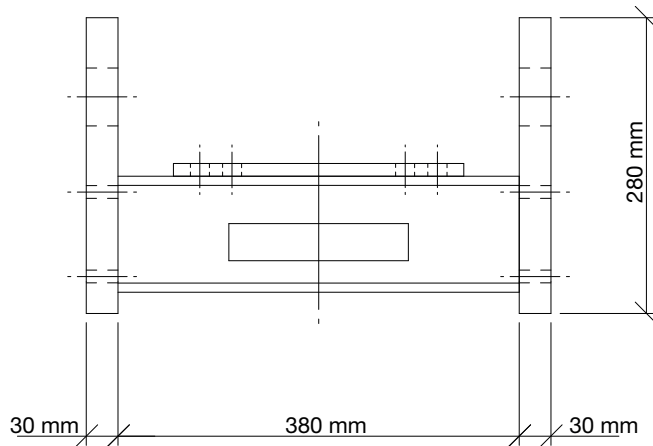

A	184 mm	B	245 mm
---	--------	---	--------

For mounting the screws (1) choose the pair of holes (A or B) in dependence to the profile of the top boom.

8 Assembly diagrams

8.6 Arrangement of standard railings

8.6.1 Standard railings (NG) and accessories

Quantity	Standard railings (NG)
1	Support block (A)
1	Flagpole holder (F)
8	Standard posts (NPF)
1	Hoop guard (RS)
11	Standard railing 350
4	Standard railing 500
5	Standard railing 750
4	Standard railing 1000
1	Standard railing 1500
12	Standard railing 2000

8.6.2 Arrangement of standard railings

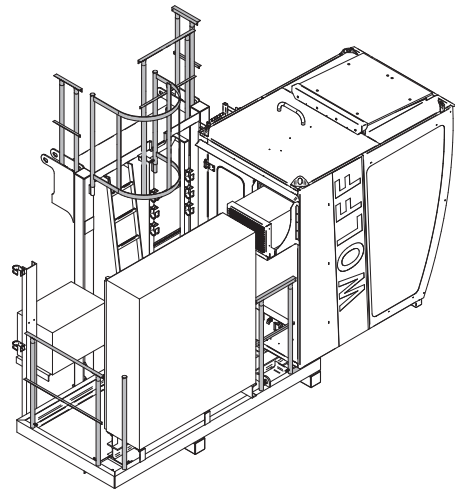
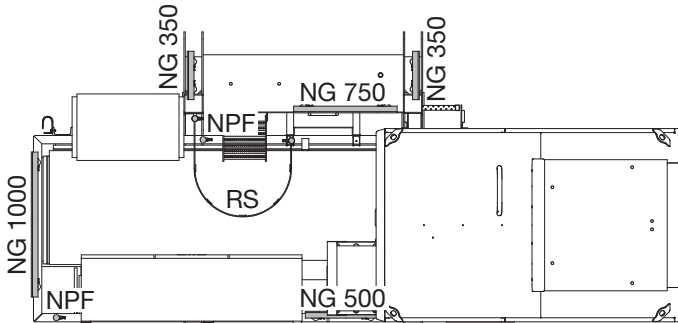

Standard railings at the driver's cab station

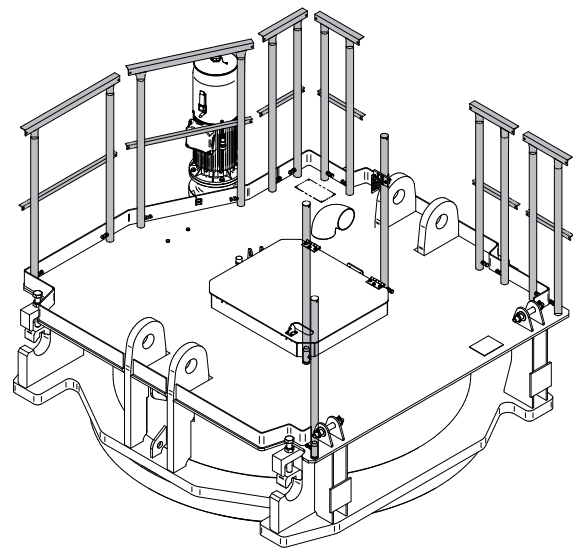
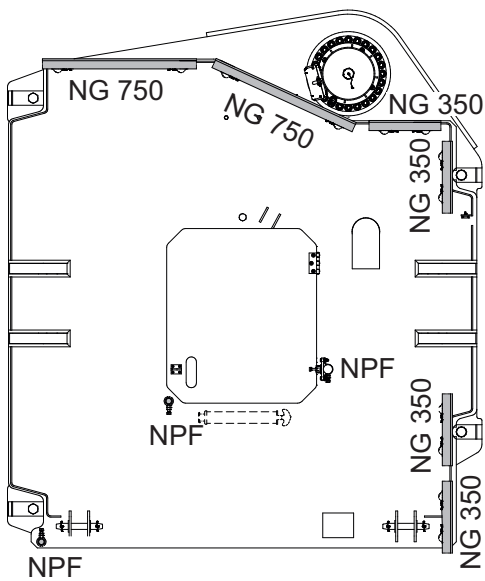

Standard railings at slewing frame

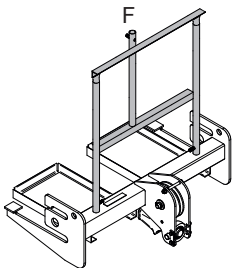

Flag pole mount at rope swivel crossbeam

8 Assembly diagrams

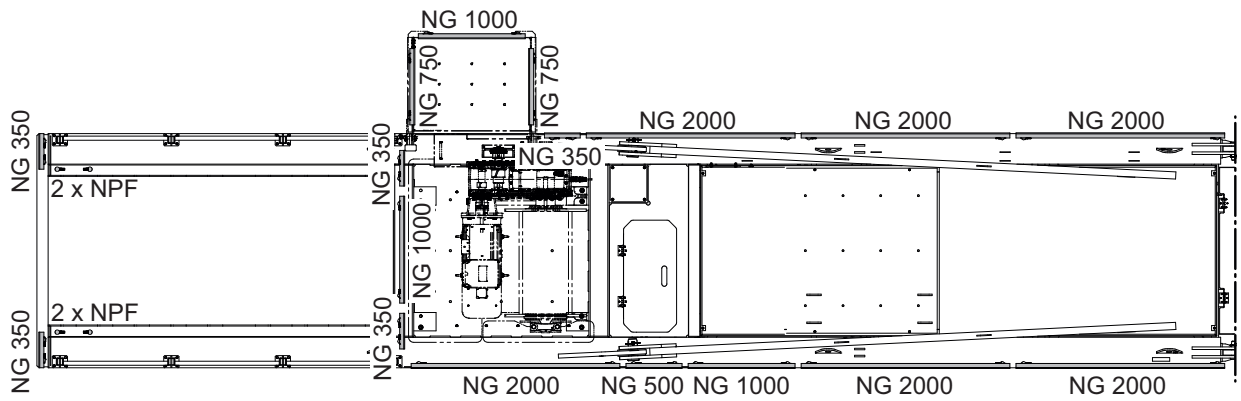
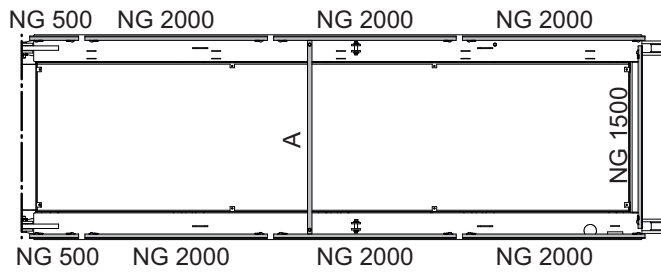



Standard railings at counterjib part 1 (above) and 2 (below)

9 Suitable climbing devices



This section contains information on

- Outer climbing devices (KWH)
- Inner climbing devices (KSH)

	<p style="text-align: center;">NOTICE</p> <p>Details on the climbing device Always refer to the details in the documentation of the climbing device.</p>
	<p style="text-align: center;">NOTICE</p> <p>The operating radius specified is measured from the tower center and is to be considered a reference value. Exact balancing can be achieved by changing the operating radius with the tower elements or loads specified in the table.</p>
	<p style="text-align: center;">NOTICE</p> <p>If feasible, preferably operate your climbing device without balancing weight.</p>

9 Suitable climbing devices

9.1 Outer climbing devices

	<p style="text-align: center;">! DANGER</p> <p>Climbing device attached to the lower part of the tower head section lower part.</p> <p>Increased wind surface. The slewing tower crane may overturn.</p> <ul style="list-style-type: none">▶ Dismantle the climbing device after the climbing procedure is finished or lower the climbing device down on the ground or lower the climbing device down to the uppermost tower brace.
	<p style="text-align: center;">NOTICE</p> <p>Tower element on the transfer carriage</p> <p>The data on climbing balance was specified under the assumption that a tower element is on the transfer carriage.</p>

9.1.1 Outer climbing device KWH 20.3 / KWH 20.3.1

Climbing radius [m] for the balancing weights

7032.8	Jib length [m]						
	70	67.5	65	62.5	60	57.5	55
no weight	-	-	-	-	-	-	-
UV 20 = 2.05 t	21.2	27.0	23.4	26.5	24.8	31.5	26.0
TV 20 = 2.98 t	14.7	19.0	16.3	18.7	17.4	22.4	18.3
Weight = 5.0 t	9.1	11.9	10.2	11.7	10.9	14.2	11.4

Climbing radius [m] for the balancing weights

7032.8	Jib length [m]					
	52.5	50	47.5	45	42.5	40
no weight	-	-	-	-	-	-
UV 20 = 2.05 t	28.4	31.1	37.0	-	-	-
TV 20 = 2.98 t	20.1	22.1	26.5	28.2	29.3	27.7
Weight = 5.0 t	12.6	14.0	16.8	17.9	18.6	17.6

Climbing radius [m] for the balancing weights

7032.8	Jib length [m]					
	37.5	35	32.5	30	27.5	25
no weight	-	-	-	-	-	-
UV 20 = 2.05 t	-	-	-	-	-	-
TV 20 = 2.98 t	29.8	-	-	-	-	-
Weight = 5.0 t	18.9	19.6	18.2	20.2	21.6	19.2

9 Suitable climbing devices

9.1.2 Outer climbing device KWH 20.6 / KWH 20.6.1 / KWH 20.6.2

Climbing radius [m] for the balancing weights

7032.8	Jib length [m]						
	70	67.5	65	62.5	60	57.5	55
no weight	-	-	-	-	-	-	-
UV 20 = 2.05 t	20.4	26.1	22.6	25.7	24.0	30.7	25.2
TV 20 = 2.98 t	14.1	18.4	15.7	18.0	16.8	21.8	17.7
Weight = 5.0 t	8.7	11.5	9.8	11.3	10.5	13.7	11.0

Climbing radius [m] for the balancing weights

7032.8	Jib length [m]					
	52.5	50	47.5	45	42.5	40
no weight	-	-	-	-	-	-
UV 20 = 2.05 t	27.6	30.3	36.1	-	-	-
TV 20 = 2.98 t	19.5	21.5	25.9	27.6	28.7	27.1
Weight = 5.0 t	12.2	13.5	16.4	17.5	18.2	17.2

Climbing radius [m] for the balancing weights

7032.8	Jib length [m]					
	37.5	35	32.5	30	27.5	25
no weight	-	-	-	-	-	-
UV 20 = 2.05 t	-	-	-	-	-	-
TV 20 = 2.98 t	29.1	-	-	-	-	-
Weight = 5.0 t	18.5	19.2	17.8	19.8	21.2	18.8

9.2 Inner climbing devices

	NOTICE
	The data required and the instructions for tower assemblies with inner climbing device is available in the separate description of the inner climbing device.

DANGER! Observe the special tower combination for the inner climbing device.

	NOTICE
	Clamping forces for the inner climbing device (KSH) are specified based on a building height of < 250m and wind category C 25.

9 Suitable climbing devices

9.2.1 Inner climbing device KSH 20 SH

Tower combinations for slewing tower cranes with inner climbing device.

Item				
1	UV 20.4	UV 20.4	UV 20.4	UV 20.4
2	UV 20.4	UV 20.4	UV 20.4	UV 20.4
3	UV 20.4	UV 20.4	UV 20.4	UV 20.4
4	UV 20.4	UV 20.4	UV 20.4	UV 20.4
5	UV 20.4	UV 20.4	UV 20.4	UV 20.4
6	UV 20.4	UV 20.4	UV 20.4	UV 20.4
7	UV 20.4	UV 20.4	UV 20.4	UV 20.4
8	TVA 20.4	UV 20.4	UV 20.4	TVA 20.4
9	TV 20.4	TVA 20.4	TVA 20.4	
10	TV 20.4	TV 20.4		
11	TV 20.4			
inner climbing device	KSH 20 SH	KSH 20 SH	KSH 20 SH	KSH 20 SH
Foundation	FUA TYPE FS-156 / FUA 156S	FUA TYPE FS-156 / FUA 156S	FUA TYPE FS-156 / FUA 156S	FUA TYPE FS-156 / FUA 156S
Tower height [m]	64.5	60.0	55.5	51.0
Hook height (2 fall operation) [m]	66.0	61.5	57.0	52.5

Climbing radius [m] for the balancing weights – WOLFF 7032.8

7032.8	Jib length [m]				
	70	67.5	65	62.5	60
UV 20.4 = 2.05 t	52.6	58.2	53.3	56.4	54.7
TV 20.4 = 2.98 t	39.5	43.7	40.1	42.4	41.1
Weight = 5.0 t	25.7	28.4	26.0	27.5	26.7
Weight = 8.0 t	-	-	-	-	-

Climbing radius [m] for the balancing weights – WOLFF 7032.8

7032.8	Jib length [m]				
	57.5	55	52.5	50	47.5
UV 20.4 = 2.05 t	-	-	-	-	-
TV 20.4 = 2.98 t	46.1	40.9	42.7	44.7	-
Weight = 5.0 t	29.9	26.5	27.7	29.0	31.8
Weight = 8.0 t	-	-	-	-	-

Climbing radius [m] for the balancing weights – WOLFF 7032.8

7032.8	Jib length [m]				
	45	42.5	40	37.5	35
UV 20.4 = 2.05 t	-	-	-	-	-
TV 20.4 = 2.98 t	-	-	-	-	-
Weight = 5.0 t	32.8	33.5	31.8	33.0	-
Weight = 8.0 t	-	-	-	-	22.1

Climbing radius [m] for the balancing weights – WOLFF 7032.8

7032.8	Jib length [m]			
	32.5	30	27.5	25
UV 20.4 = 2.05 t	-	-	-	-
TV 20.4 = 2.98 t	-	-	-	-
Weight = 5.0 t	-	-	-	-
Weight = 8.0 t	20.8	22.0	22.8	20.8

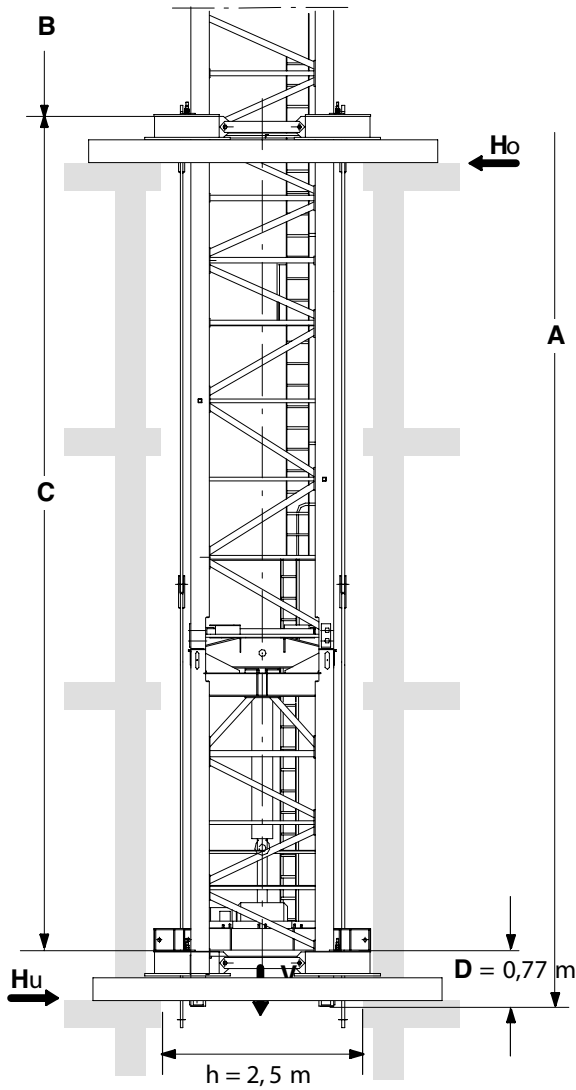

$$C_{\min} = 11,0 \text{ m}$$

$$C_{\max} = 14,0 \text{ m}$$

$$H_o = \frac{M}{C} + H$$

$$H_u = H_o - H$$

$$T = \frac{M_D}{2 \times b}$$

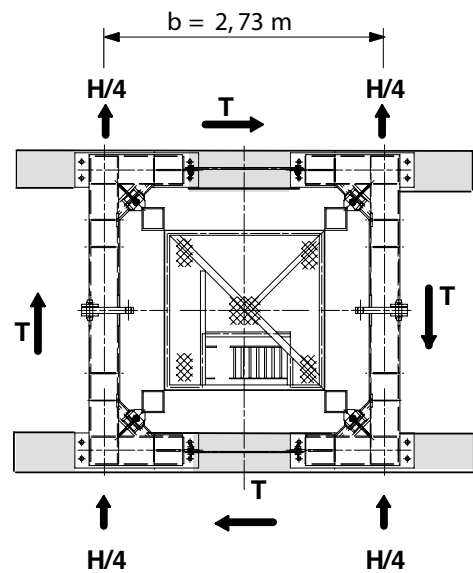

A	Tower height	C	Distance between guide frames
B	A-C-D		

9 Suitable climbing devices

In service clamping forces

In service clamping forces [kN] inside a building																
A [m]	64.5				60.0				55.5				51.0			
C [m]	11.0	12.0	13.0	14.0	11.0	12.0	13.0	14.0	11.0	12.0	13.0	14.0	11.0	12.0	13.0	14.0
V	1176				1138				1110				1091			
Ho	440	410	380	350	420	380	350	330	390	360	330	310	370	340	310	290
Hu	390	360	330	300	370	340	310	280	350	320	290	260	320	290	270	250
T	66				66				66				66			

Out of service clamping forces

Out of service clamping forces [kN] inside a building																
A [m]	64.5				60.0				55.5				51.0			
C [m]	11.0	12.0	13.0	14.0	11.0	12.0	13.0	14.0	11.0	12.0	13.0	14.0	11.0	12.0	13.0	14.0
V	1046				1008				980				961			
Ho	900	830	760	710	790	730	670	620	700	640	590	550	610	560	520	480
Hu	650	570	510	460	550	490	430	390	470	410	370	320	400	350	300	270
T	-				-				-				-			

10 Arrangement of counterweight blocks

L = 70 m	L = 67.5 m	L = 65 m	L = 62.5 m	L = 60 m
7 x 2.7 t	7 x 2.7 t	6 x 2.7 t	6 x 2.7 t	6 x 2.7 t
a →	a →	a →	a →	a →
W = 18.9 t	W = 18.9 t	W = 16.2 t	W = 16.2 t	W = 16.2 t
L = 57.5 m	L = 55 m	L = 52.5 m	L = 50 m	L = 47.5 m
6 x 2.7 t	5 x 2.7 t	5 x 2.7 t	5 x 2.7 t	5 x 2.7 t
a →	a →	a →	a →	a →
W = 16.2 t	W = 13.5 t	W = 13.5 t	W = 13.5 t	W = 13.5 t
L = 45 m	L = 42.5 m	L = 40 m	L = 37.5 m	L = 35 m
5 x 2.7 t	5 x 2.7 t	4 x 2.7 t	4 x 2.7 t	4 x 2.7 t
a →	a →	a →	a →	a →
W = 13.5 t	W = 13.5 t	W = 10.8 t	W = 10.8 t	W = 10.8 t
L = 32.5 m	L = 30 m	L = 27.5 m	L = 25 m	
3 x 2.7 t	3 x 2.7 t	3 x 2.7 t	2 x 2.7 t	
a →	a →	a →	a →	
W = 8.1 t	W = 8.1 t	W = 8.1 t	W = 5.4 t	

	Intermediate ballast 1 x 2.7 t		Counterweight block 1 x 2.7 t
	No counterweight	L	Jib length [m]
a	To the tower	G	Total weight [t]

WOLFFKRAN Group

Headquarter international:

WOLFFKRAN AG

Baarermattstraße 6

CH-6300 Zug

Switzerland

Phone +41 41 766 85 00

Fax +41 41 766 85 99

info@wolffkran.com

Manufacturing:

WOLFFKRAN GmbH

Austraße 72

D-74076 Heilbronn

Germany

Phone + 49 7131 9815 0

Fax + 49 7131 9815 355

info@wolffkran.de

WOLFFKRAN Werk Brandenburg GmbH

Frederik-Ipsen-Straße 5

D-15926 Luckau OT Alverno

Germany

Phone + 49 35456 674 0

Fax + 49 35456 674 200

info@wolffkran.de