



T 340-1 / T 340-1 XL
40 USt Lifting Capacity
Truck Crane
Datasheet
Imperial

T 340-1 T 340-1 XL



Features: T 340-1

- ▶ 40 USt maximum lifting capacity
- ▶ 94 ft maximum boom length
- ▶ 99 ft maximum tip height
- ▶ Engine power 300 hp
- ▶ Travel speeds up to 60 mph

Features: T 340-1 XL

- ▶ 40 USt maximum lifting capacity
- ▶ 105 ft maximum boom length
- ▶ 110 ft maximum tip height
- ▶ Engine power 300 hp
- ▶ Travel speeds up to 60 mph

WORKS FOR YOU.™

Key

..... 3

Dimensions

Crane dimensions 4, 5
Crane weights 6
Range diagram 7

Load charts, T 340-1

Main boom, outriggers fully extended (100%) 8
Main boom, outriggers fully fully retracted (0%) 8
Main boom, 32 ft offsettable jib 9
Main boom, 49 ft offsettable jib 9
Main boom, on tires 9

Load charts, T 340-1 XL

Main boom, outriggers fully extended (100%) 10
Main boom, outriggers fully fully retracted (0%) 10
Main boom, 32 ft offsettable jib 11
Main boom, 49 ft offsettable jib 11
Main boom, on tires 11

Technical description

Boom 12
Hoist, rope, and hook 12, 13
Cab, controls, operator aids and load limiter / load indicator 13
Superstructure 14
Counterweight 14
Tires 14
Vehicle performance 14
Hydraulic system 14
Carrier, engine, and drive-line 15

KEY

T 340-1 / T 340-1 XL

	Boom length		General performance
	Tip height		Hoist speed
	Boom with extension		Rope – Standard / Optional
	Telescoping mode		Rope diameter
	Boom angle		Rope length
	Working radius		Max. line pull
	Max. boom length with extension		Electrical system
	Main boom with aux head		Tires
	Hook and block		Engine
	Hook and ball		Steering
	Gradeability		Speed
	Crane / Crane in standard configuration		Slewing / Allowable slewing range
	Gross vehicle weight		Slewing brake
	Weight on front axle		Main hoist
	Weight on rear axle		Auxiliary hoist
	Counterweight		Cab
	Outriggers		Operator aids / Load limiter / Load indicator
	Swing/Rotation		Transmission
	Over rear		Hydraulics

CRANE DIMENSIONS

T 340-1 / T 340-1 XL

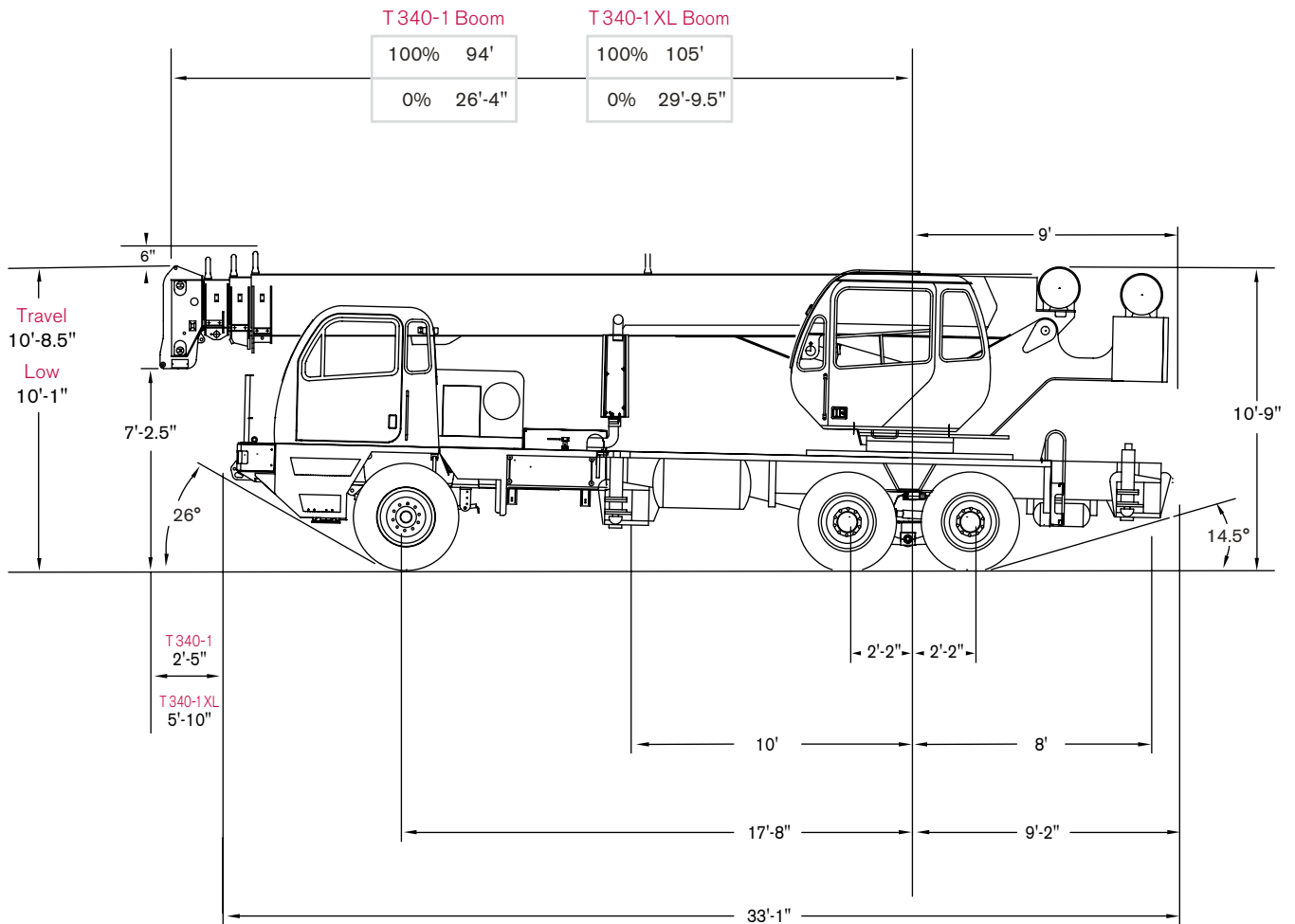

CRANE DIMENSIONS



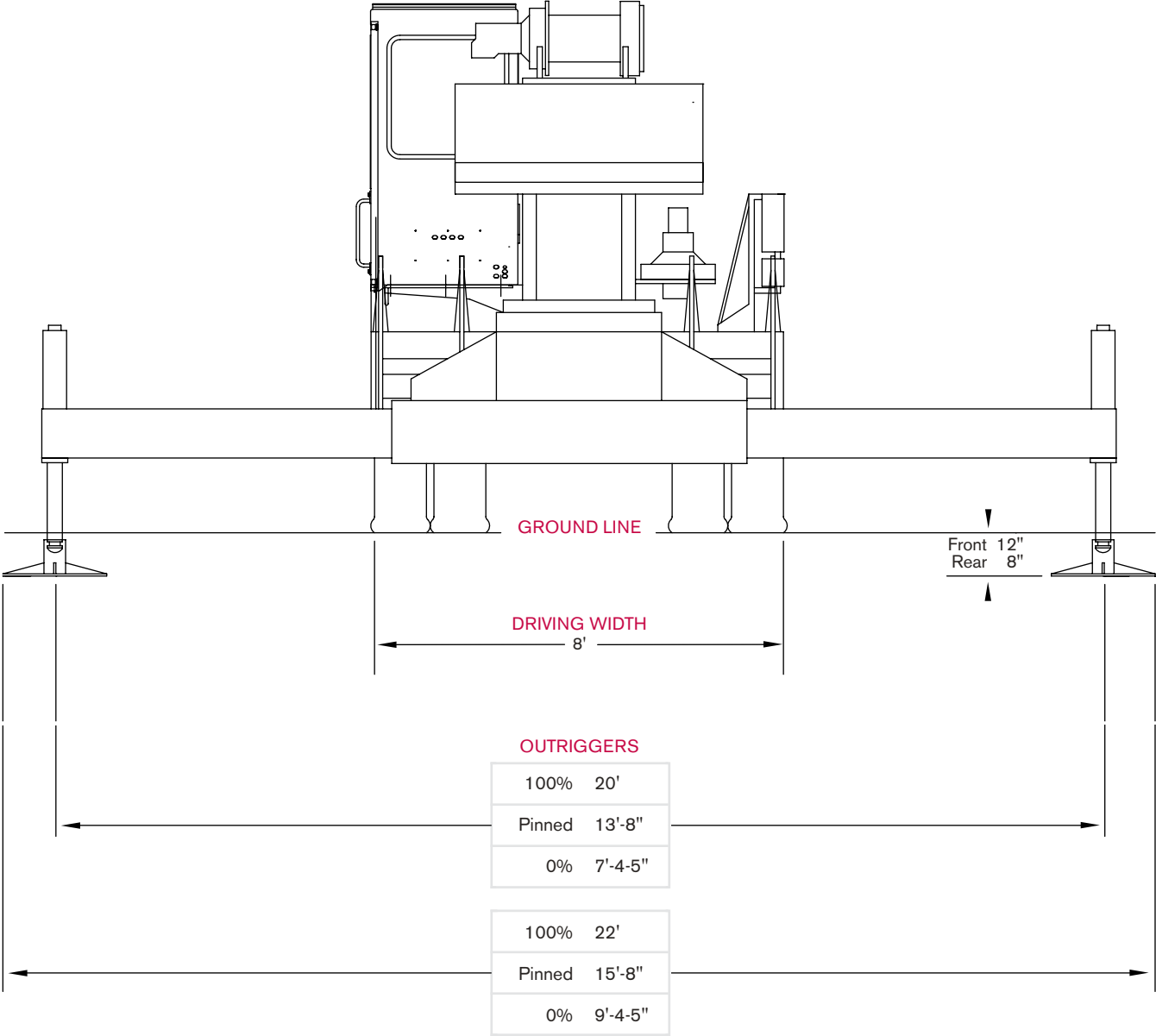





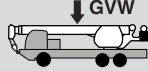
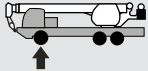
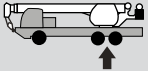
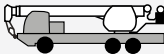

T 340-1 / T 340-1 XL



SPECIFICATIONS

T 340-1 / T 340-1 XL

Approximate Crane Weights

Boom in front travel position		 Gross Vehicle	 Front max. 22,000 lb	 Rear max. 45,000 lb
Configurations: 	T 340-1 1/4 tank fuel 200 lb operator seated in cab Front tires: 425/65 R22.5-20PR Rear tires: 11R22-14PR 94 ft boom/no jib 2,000 lb total counterweight	47,101	16,575	30,525
	T 340-1XL 1/4 tank fuel 200 lb operator seated in cab Front tires: 425/65 R22.5-20PR Rear tires: 11R22-14PR 105 ft boom/no jib 11,000 lb total counterweight	60,053	16,515	43,528
Add options				
	Full tank of fuel	+ 315	+ 120	+ 195
	Heater/defroster in upper cab	+ 60	- 5	+ 65
	Auxiliary hoist with drum roller and wire rope	+ 175	- 73	+ 248
	Electric remote control	+ 200	+ 100	+ 100
	32 ft swing-on jib - 94' boom	+ 1,368	+ 797	+ 571
	32 ft swing-on jib - 105' boom	+ 1,368	+ 1,117	+ 251
	32 ft to 49 ft extendable swing-on jib - 94' boom	+ 1,789	+ 1,007	+ 785
	32 ft to 49 ft extendable swing-on jib - 105' boom	+ 1,789	+ 1,343	+ 446
	Auxiliary boom head - 94' boom	+ 100	+ 154	- 54
	Auxiliary boom head - 105' boom	+ 100	+ 170	- 70
	40 USt hook block on bumper	+ 690	+ 973	- 283
	7 USt hook and ball at bottom rack	+ 240	+ 145	+ 95
Substitute options				
	7,200 lb counterweight with 1,850 lb front bumper counterweight - 94' boom	+ 6,636	- 619	+ 7,255
	Spin resistant wire rope (per winch)	+ 32	- 12	+ 44

RANGE DIAGRAM - MAIN BOOM

T 340-1 / T 340-1 XL

Outriggers Fully Extended (100%)

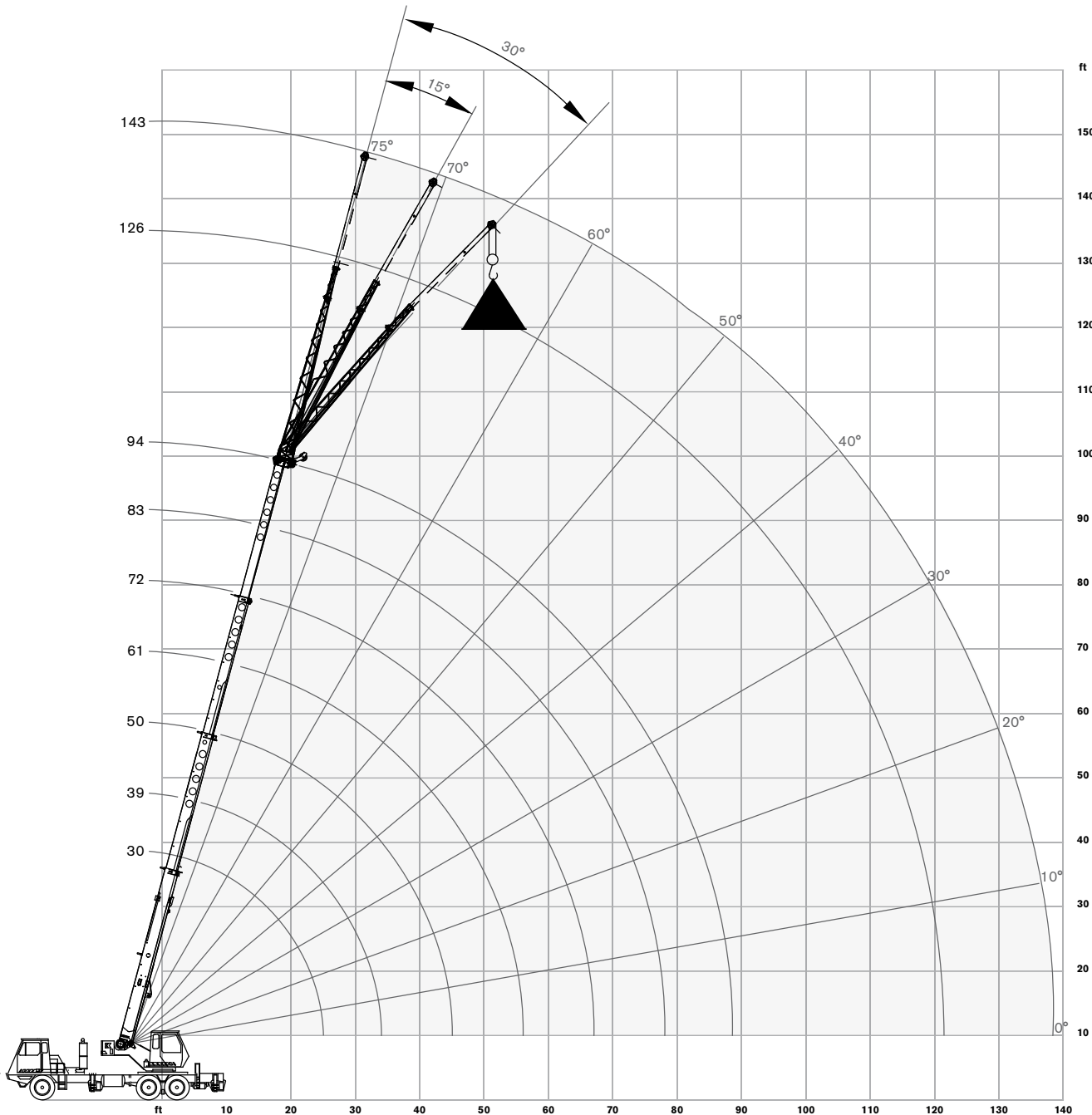

LOAD CHART - MAIN BOOM

T 340-1

Outriggers Fully Extended (100%)

 7,200 lbs

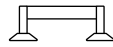
 100%

 360°

 30-94 ft

Standard ASME B30.5

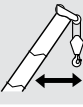
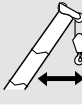
	Boom Length (ft)							
	30	39	50	61	72	83	94	
ft	lb	lb	lb	lb	lb	lb	lb	ft
9	80,000							9
10	70,000	46,500						10
12	60,900	46,500	46,500					12
15	49,300	46,500	44,200	38,000				15
20	35,200	36,000	36,500	32,900	27,300			20
25	26,600	27,500	28,000	27,800	23,000	21,700	17,400	25
30		19,800	20,300	20,600	19,800	18,200	14,900	30
35			15,200	15,500	15,700	15,800	13,000	35
40			11,700	12,100	12,200	12,400	11,400	40
45			9,200	9,600	9,800	9,900	10,000	45
50				7,700	7,900	8,100	8,200	50
55				6,300	6,500	6,600	6,700	55
60					5,300	5,500	5,600	60
65					4,400	4,500	4,600	65
70						3,700	3,900	70
75						3,100	3,200	75
80							2,600	80
85							2,100	85

Outriggers Fully Retracted (0%)

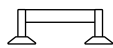

 7,200 lbs

 0%

 360°

 30-94 ft

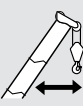
Standard ASME B30.5

	Boom Length (ft)							
	30	39	50	61	72	83	94	
ft	lb	lb	lb	lb	lb	lb	lb	ft
9	35,200							9
10	28,600	29,300						10
12	20,400	21,000	21,500					12
15	13,500	14,100	14,500	14,700				15
20	7,400	8,100	8,500	8,800	8,900			20
25	4,000	4,900	5,400	5,600	5,800	5,900	6,000	25
30		2,800	3,400	3,600	3,800	3,900	4,000	30
35			2,000	2,300	2,500	2,600	2,600	35

Notes to lifting capacity

Lifting capacities do not exceed 85% of tipping load. Weight of hook blocks and slings is part of the load, and is to be deducted from the capacity ratings. Consult operation manual for further details.

Note: Data published herein is intended as a guide only and shall not be construed to warrant applicability for lifting purposes. Crane operation is subject to the computer charts and operation manual both supplied with the crane.



LOAD CHART - MAIN BOOM

T 340-1

With Offset Jibs

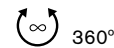
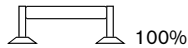
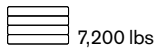

Standard ASME
B30.5

32 ft Offsettable Jib					
0° Offset		15° Offset		30° Offset	
ft	lb	ft	lb	ft	lb
38	9,000	46	7,600	52	5,800
42	8,500	49	7,200	55	5,700
45	8,100	52	6,900	58	5,500
50	7,300	58	6,100	63	5,000
56	6,200	63	5,400	68	4,500
61	4,900	68	4,600	73	4,100
66	4,000	73	3,900	77	3,700
73	3,400	79	3,200	83	3,000
79	2,800	85	2,500	88	2,400
86	2,200	91	2,000	94	2,000
92	1,800	97	1,600	99	1,600
100	1,300	103	1,200	105	1,200
106	800	109	800	110	800

49 ft Offsettable Jib					
0° Offset		15° Offset		30° Offset	
ft	lb	ft	lb	ft	lb
41	5,000	55	3,300	62	2,600
47	4,700	59	3,200	68	2,600
52	4,400	64	3,100	73	2,500
60	4,000	70	2,900	79	2,400
66	3,700	76	2,800	84	2,400
71	3,500	81	2,700	88	2,300
77	3,300	86	2,600	93	2,300
84	2,900	93	2,300	99	2,200
91	2,300	99	1,900	105	1,900
100	1,800	106	1,500	110	1,500
109	1,400	112	1,200	116	1,200
116	900	119	900	122	900
122	600	126	500	127	500

On Tires

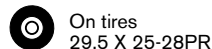
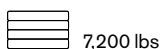

Standard ASME
B30.5

Boom		Travel Speed: Boom straight over rear		
ft	ft	0 mph	Creep	2.5 mph
		lb	lb	lb
10	30	19,200	19,200	19,200
12	30	15,800	15,800	15,800
15	39	12,100	12,100	12,100
20	39	7,600	7,600	7,600
25	50	5,100	5,100	5,100
30	50	3,600	3,600	3,600
35	50	2,600	2,600	2,600
40	50	1,700	1,700	1,700

Notes to lifting capacity

Lifting capacities do not exceed 85% of tipping load, (75% of tipping load on tires). Weight of hook blocks and slings is part of the load, and is to be deducted from the capacity ratings. Consult operation manual for further details.

Note: Data published herein is intended as a guide only and shall not be construed to warrant applicability for lifting purposes. Crane operation is subject to the computer charts and operation manual both supplied with the crane.

LOAD CHART - MAIN BOOM

T 340-1 XL

Outriggers Fully Extended (100%)

11,000 lbs

100%

360°

33.75–105 ft

Standard ASME
B30.5

	Boom Length (ft)							
	33.75	45	57	69	81	93	105	
ft	lb	lb	lb	lb	lb	lb	lb	ft
9	80,000							9
10	64,400	46,500						10
12	58,000	46,500	46,500					12
15	50,700	46,500	44,500	41,600				15
20	38,400	38,800	36,400	34,800	30,600			20
25	28,600	29,600	30,200	29,400	26,000	23,400		25
30		22,500	23,100	23,400	22,500	20,300	18,600	30
35		16,800	17,300	17,600	17,800	17,700	16,200	35
40		12,700	13,400	13,700	13,900	14,100	14,200	40
45			10,700	11,000	11,200	11,300	11,400	45
50			8,500	8,900	9,100	9,200	9,300	50
55				7,300	7,500	7,600	7,700	55
60				5,900	6,200	6,300	6,400	60
65					5,100	5,200	5,300	65
70					4,200	4,300	4,400	70
75					3,400	3,600	3,700	75
80						2,900	3,000	80
85						2,300	2,500	85
90							2,000	90
95							1,500	95
100							1,100	100

Outriggers Fully Retracted (0%)

11,000 lbs

0%

360°

33.75–105 ft

Standard ASME
B30.5

	Boom Length (ft)							
	33.75	45	57	69	81	93	105	
ft	lb	lb	lb	lb	lb	lb	lb	ft
10	36,400	37,300						10
12	26,000	26,800	27,300					12
15	17,200	18,100	18,500	18,800				15
20	9,600	10,600	11,000	11,300	11,400			20
25	5,500	6,500	7,000	7,300	7,400	7,600		25
30		3,900	4,500	4,800	4,900	5,100	5,200	30
35		2,100	2,700	3,000	3,200	3,400	3,500	35
40		700	1,400	1,800	2,000	2,100	2,200	40
45					1,000	1,200	1,300	45

Notes to lifting capacity

Lifting capacities do not exceed 85% of tipping load. Weight of hook blocks and slings is part of the load, and is to be deducted from the capacity ratings. Consult operation manual for further details.

Note: Data published herein is intended as a guide only and shall not be construed to warrant applicability for lifting purposes. Crane operation is subject to the computer charts and operation manual both supplied with the crane.



LOAD CHART - MAIN BOOM

T 340-1 XL

With Offset Jibs

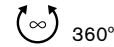
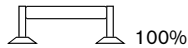
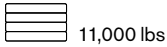

Standard ASME B30.5

32 ft Offsettable Jib					
0° Offset		15° Offset		30° Offset	
ft	lb	ft	lb	ft	lb
43	9,200	51	8,400	57	6,500
47	8,800	55	8,100	61	6,300
51	8,400	59	7,700	65	6,200
56	7,600	64	6,300	70	5,900
62	6,100	69	5,200	75	5,000
68	5,000	75	4,400	80	4,200
74	4,100	81	3,800	85	3,400
80	3,100	87	2,900	91	2,800
87	2,400	93	2,200	97	2,200
94	1,900	99	1,800	102	1,700
101	1,400	105	1,400	107	1,300
108	900	112	900	113	800

49 ft Offsettable Jib					
0° Offset		15° Offset		30° Offset	
ft	lb	ft	lb	ft	lb
47	5,000	57	3,300	66	2,600
52	4,700	63	3,200	71	2,600
58	4,400	69	3,100	76	2,500
65	4,000	76	2,900	82	2,400
72	3,700	83	2,800	89	2,400
79	3,500	89	2,700	95	2,300
86	3,300	95	2,600	101	2,300
93	2,600	102	2,400	107	2,200
101	2,000	108	1,900	113	1,700
108	1,500	114	1,400	119	1,200
115	1,100	120	1,000	125	900
122	700				

On Tires

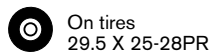
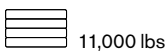

Standard ASME B30.5

Boom		Travel Speed: Boom straight over rear		
ft	ft	0 mph	Creep	2.5 mph
		lb	lb	lb
10	33.75	21,700	21,700	16,500
12	33.75	15,600	15,600	14,900
15	45	12,800	12,800	12,700
20	45	8,500	8,500	8,500
25	45	5,800	5,800	5,800
30	45	3,800	3,800	3,800
35	57	2,500	2,500	2,500
40	57	1,700	1,700	1,700
45	57	1,000	1,000	1,000









Notes to lifting capacity

Lifting capacities do not exceed 85% of tipping load, (75% of tipping load on tires). Weight of hook blocks and slings is part of the load, and is to be deducted from the capacity ratings. Consult operation manual for further details.



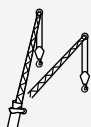
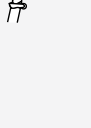

Note: Data published herein is intended as a guide only and shall not be construed to warrant applicability for lifting purposes. Crane operation is subject to the computer charts and operation manual both supplied with the crane.

TECHNICAL DESCRIPTION

Boom





Standard configuration:			
	Full power extension via foot pedal control		4 sections
	Minimum / Maximum	T 340-1 T 340-1 XL	30 ft / 94 ft 33.75 ft / 105 ft
	Maximum tip height	T 340-1 T 340-1 XL	99 ft 110 ft
	Boom elevation angle range (min. / max.)	T 340-1 T 340-1 XL	-4° / 77° -4° / 88°
Optional configuration:			
	32 ft swing-on jib, fixed length		
	Angular offsets		0°, 15°, 30°
	Maximum tip height with fixed jib	T 340-1 T 340-1 XL	129 ft 140 ft
	32–49 ft swing-on jib with 25 ft extension		
	Angular offsets		0°, 15°, 30°
	Maximum tip height with extended jib	T 340-1 T 340-1 XL	147 ft 158 ft
	3 or 4 metallic load sheaves Quick reeving design		
	Single nylon sheave Installs only on main boom head, compatible with extendable and fixed swing-on jibs		
	4 sheave Quick reeving design		40 USt
	Top swivel ball with hook and latch		7 USt

Hoist, Rope and Hook



Standard configuration:			
	Two speed ratios		
	1st layer without load (low range / high range)		167 ft/min / 335 ft/min
	5th layer without load (low range / high range)		242 ft/min / 487 ft/min
	Maximum line pull		
	1st layer (low speed/ high speed)		15,639 lb / 7,298 lb
	5th layer (low speed/ high speed)		10,827 lb / 5,052 lb
	Permissible line pull		9,000 lb
	6x19 IWRC XIPS		
	Rope diameter		5/8 in
	Maximum usable		455 ft

TECHNICAL DESCRIPTION

Hoist, Rope and Hook



Optional configuration:		
	Two speed ratios 1st layer without load (low range / high range) 5th layer without load (low range / high range)	167 ft/min / 335 ft/min 242 ft/min / 487 ft/min
	Maximum line pull 1st layer (low speed/ high speed) 5th layer (low speed/ high speed) Permissible line pull	15,639 lb / 7,298 lb 10,827 lb / 5,052 lb 9,000 lb
	Rotation resistant compacted strand 18 x 19	
	Rope diameter	5/8 in

Cab, Controls, Operator aids and Load limiter / Load indicator

Standard configuration:	
	<p>Upper cab: Sliding door on left side Sliding window on the right side Tilting, tinted glass skylight Removable front windshield Six-way adjustable seat with armrest dual-axis electro-proportional joysticks Joystick control for hoist(s), swing and boom elevation Foot pedals for swing brake, boom telescope and engine rpm Hand control for engine rpm</p> <p>Lower cab: Hinged door on left side with roll-down window Sliding window on the right side Six-way adjustable seat with seatbelt Cruise control Two speed windshield wiper with washer</p>
	<p>Rated capacity indicator with pictograph display of boom radius, boom angle, boom length, allowable load, actual load and % of allowable load</p> <p>Settable alarms for swing angle, boom length, boom angle, tip height and work area exclusion zone</p>
Optional configuration:	
	<p>Upper cab: Air conditioning – hydraulically powered Heater and air conditioning package – hydraulically powered Liquid Propane (LP) Cab Heater Single-Axis armrest mounted controls Work Lights Upper cab remote carrier control AM/FM radio with cassette</p> <p>Lower cab: Jacobs engine brake</p>

TECHNICAL DESCRIPTION

Superstructure

Standard configuration:		
	Foot pedal actuated multi-disc brake and air actuated house lock	360°
	Hydraulic driven double planetary reduction gear drive	2.5 rpm



Counterweight

	Three counterweight packages available	2,000 / 7,200 / 11,000 lbs
---	--	----------------------------

Tires

Standard configuration:		
	Aluminium wheels with stainless hub covers	
	Front Tires	445 / 65 R22.5-20PR
	Rear Tires	11 R22-14PR

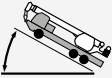
Vehicle performance

Standard configuration:		
	Theoretical maximum	
	Manual transmission	56%
	Automatic transmission	64%
	Manual transmission	60 mph
	Automatic transmission	60 mph

Hydraulic system

Standard configuration:		
	Triple Pumps:	
	Hoist pump	60.3 gal/min @ 3,500 psi
	Boom lift / telescope	45.1 gal/min @ 3,500 psi
	Outriggers / swing	22 gal/min @ 2,500 psi
	Single pump:	
	Power Steering	8 gal/min @ 2,000 psi
	Full Flow with bypass protection:	
	Suction	52.7 gal/min @ 4,500 psi
	Return	250 micron screen 5 micron filter
	Pressurized tank with sight level gauge	91 gal

TECHNICAL DESCRIPTION

Carrier, Engine and Drive-line

Standard configuration:	
	<p>Turn radius to centerline of tires 34 ft</p>
	<p>Axle drive system 6 x 4 drive Air brakes with ABS, Air release / spring set</p>
	<p>Engine and transmission, EPA 2010 compliant 8.3 L / 300 hp @ 2,000 rpm Cummins ISC Intake: Turbocharger with intercooler Rated power Eaton Fuller 10-speed manual transmission Fuel type: Diesel</p>
	<p>Fuel tank capacity 60 gallon</p>
	<p>Voltage 12 VDC 2 Batteries 1,000 CCA each Alternator 130 amp</p>
Optional configuration:	
	<p>Engine and transmission, EPA 2010 compliant 8.3 L / 300 hp @ 2,000 rpm Cummins ISC Intake: Turbocharger with intercooler Rated power Allison 7-speed automatic transmission with lock-up torque converter Fuel type: Diesel</p>
	<p>Engine and transmission, Non-EPA 2010 compliant 8.3 L / 275 hp @ 2,200 rpm Cummins QSC Intake: Turbocharger with intercooler Rated power Eaton Fuller 10-speed manual transmission Fuel type: Diesel</p>

Effective Date: September 2012. Product specifications and prices are subject to change without notice or obligation. The photographs and/or drawings in this document are for illustrative purposes only. Refer to the appropriate Operator's Manual for instructions on the proper use of this equipment. Failure to follow the appropriate Operator's Manual when using our equipment or to otherwise act irresponsibly may result in serious injury or death. The only warranty applicable to our equipment is the standard written warranty applicable to the particular product and sale and Terex makes no other warranty, express or implied. Products and services listed may be trademarks, service marks or trade-names of Terex Corporation and/or its subsidiaries in the USA and other countries. All rights are reserved. Terex® is a registered trademark of Terex Corporation in the USA and many other countries. Copyright 2012 Terex Corporation.

Terex Cranes, Global Marketing, Dinglerstraße 24, 66482 Zweibrücken, Germany
Tel. +49 (0) 6332 830, Email: info.cranes@terex.com, www.terexcranes.com



www.terexcranes.com

Brochure Reference: TC-DS-I-E-TC 340-1XX 09/12



WORKS FOR YOU.™

Courtesy of Crane.Market