

# GTC-1300

## 130 Ton Telescopic Boom Crawler Crane

SPECIFICATION SHEET NO. TMC-DI-02-001-06/20

### GENERAL DATA

<b>CRANE CAPACITY</b>	130 ton at 10 feet (120t at 3.0m)
<b>BOOM</b>	5-section, 42'1" – 155'0" (12.8 m – 47.2 m)
<b>DIMENSION</b>	
Overall Length	51' 9" (15.8 m)
Overall Width (tracks extended)	19' 1" (5.8 m)
Overall Width (tracks retracted)	12' 0" (3.66 m)
Overall Width (tracks removed)	9' 9" (2.97 m)
Overall Height (working)	14' 10" (4.5 m)
<b>MASS</b>	
Gross Vehicle Mass (Standard Equipment Package)	259,993 lb (117,931 kg)
Maximum Counterweight	Upper = 70,000 lb (31750 kg) Carbody = 20,000 lb (9070 kg)
<b>PERFORMANCE</b>	
Travel Speed	0.5 mph (0.7 km/hr)/ 1.4 mph (2.2 km/h)
Gradeability	70%

### CRANE SPECIFICATION

<b>MODEL</b>	<b>CAPACITY</b>
GTC-1300	130 ton at 10 feet (120t at 3.0m)

#### BOOM

5-section full power telescoping boom with 2 extension modes. System consists of three double acting hydraulic cylinders with load holding valves and extension and retraction cables.

- Retracted Length: 42' 1" (12.8m)
- Extended Length: 155' 0" (47.2 m)
- Extension Time: 200 s
- Elevating Angles: -2° to 82°
- Elevating Time: 89 s
- Boom Head: Eight, 21.4 inch (543 mm) diameter cast nylon sheaves on heavy-duty roller bearings (6 load bearing and 2 lead in sheaves). Designed for quick reeving of head and load block.

#### AUXILIARY BOOM HEAD

Quick reeve, single 21.4 inch (543 mm) diameter high-strength, cast nylon sheave mounted on a heavy-duty roller bearing. Allows single or 2 part reeving.

### COUNTERWEIGHT

6 piece counterweight design. Three upper counterweight configurations

- "A" Configuration = 23,350lb (10590 kg)
- "B" Configuration = 46,700lb (21180 kg)
- "C" Configuration = 70,000lb (31750 kg)
- Two carbody counterweights, 10,000lb (4535kg) each

### WINCHES

Planetary geared two-speed winch includes a hydraulic motor, multi-disc internal brake, counterbalance valve, grooved drum, cable follower, and 3rd wrap indicator. Drum rotation indicator is included (complete winch performance specs on Page 3)

- Main Winch
  - o Rope Diameter and Length: 7/8" x 758 ft (22mm x 231m)
  - o Single line pull: 23,560 lb (104.8 kN)(first layer)
  - o Single line speed: 293 ft/min (89.4 m/min)(5th layer)
- Auxiliary Winch
  - o Rope Diameter and Length: 7/8" x 613 ft (22mm x 187m)
  - o Single line pull: 23,560 lb (104.8 kN)(first layer)
  - o Single line speed: 293 ft/min (89.4 m/min)(5th layer)

### TRAVEL

Each side frame contains a pilot controlled, two-speed track drive with hydraulic axial piston motor and parking brake. Travel system provides skid steering and counter rotation.

- Travel speed - 0.5 mph (0.7 km/h) High: 1.4 mph (2.2 km/h)
- Gradeability (unladen): 70%

### SWING

Closed loop hydrostatic transmission with electronic displacement controlled piston pump. Operator selectable modes allow for either free swing with counter-swing or closed loop swing. Swing motor drives planetary gear reducer with a shaft mounted pinion, external gear shear ball slew bearing bolted to the superstructure and the carbody allows the superstructure to rotate 360°.

- Swing Speed: 0 - 1.5 rpm
- Swing Parking Brake: Spring applied failsafe brake with hydraulic release that is controlled from the operators cab
- Swing Service Brake: Hydraulically applied, controlled through foot actuated pedal
- House Lock Systems:
  - o 4-position house lock (boom over front, rear or either side). Actuated from the operator's cab.

### LOAD MOMENT INDICATOR

TADANO AML-C Rated Capacity Limiter and Anti-Two Block system

- OPTI-WIDTH™ - OPTIMAL lifting performance at any track width.
- Control function shutdown. Audible and visual warnings
- LCD screen provides a continuous display of working boom length, boom angle, working load radius, tip height, swing position, parts-of-line (operator set), machine track configuration, relative load moment, maximum permissible load and actual load.
- Anti-two block weight allows quick reeving of hook block
- Operator configurable working range limits with automatic soft stop.

## FRAME

The frame is an all-steel, welded structure, precision machined to accept attachment of the boom and swing components.

## OPERATORS CAB

Fully-enclosed, air conditioned all-steel modular cab with lockable sliding door, acoustical lining, anti-slip floor and tinted safety glass.

- Cab tilts 20°.
- Rear view, winch view, and right side view cameras are appropriately located as are three remote control work lights.
- Grab bars and steps are located for easy access to the cab.
- Defroster, heater, circulating fan
- 2-speed windshield wiper, top glass wiper
- Six-way adjustable fabric seat with headrest, seat belt
- Dome light
- Dry-chemical fire extinguisher
- Four-way electronic armrest mounted joysticks control swing, main winch, auxiliary winch, boom extend, and boom hoist. Electronic foot pedals control the travel. Hydraulic brake pedal controls swing service brake function.
- Selectable modes for Fine Control and Travel (using hand control for crane travel)
- Seat termination switch immediately disable all hydraulic functions as the operator rises from the seat. Functions can also be disabled by switch on console.
- Dash instrumentation: tachometer, hour meter, fuel gauge, and DEF level gauge. Indicators are provided for crane level, swing position, load moment, drum rotation, air filter restriction, engine oil temperature and pressure, hydraulic oil temperature and level, and hydraulic and air filter restriction, and low voltage.

## ENGINE

- Make/ Model: Cummins QSL9
- Type: 6 Cylinder, Water cooled, 4 Cycle
- Aspiration: Turbocharged and Aftercooled
- Max. Output: 350 hp (261 kW) @ 2100 RPM
- Max Torque: 1,201Lb-ft (1,628 Nm) @ 1500 RPM
- Piston Disp: 8.9 L
- Emission Cert: U.S. EPA Tier 4f, Euromot Stage IV
- Alternator: 70 amp
- Throttle control by: accelerator pedal, auto-idle, or adaptive throttle control.

## ELECTRICAL SYSTEM

24 VDC

## FUEL SYSTEM

- Capacity: 125 gallon (473 liter)
- Filtration: Inline fuel/water separator and engine mounted fuel filter

## SIDE FRAMES

Two welded steel side frames are paired with a track group. The side frames extend and retract hydraulically and are controlled from the cab.

- Track Rollers: Two top and fourteen bottom sealed rollers on each track frame Idler: Oil filled, self lubricating with nitrogen type tensioner
- Track Shoes: 36 inch (900 mm), 3-bar semi grouser

## HYDRAULIC SYSTEM

- Hydraulic Pumps: Two high pressure, variable axial piston pumps with load sense and power limiting control for crane functions. One axial piston pump for swing function.
- Directional Valves: Multiple pressure and flow compensated valves with integrated relief valves controlled by electrical signals.
- Pump output: 222 gpm (840 l/min) @ 2100 RPM engine speed. 5,000 psi (345 bar) maximum pressure
- Reservoir: 366 gallon (1385 liter) capacity, filler breather cap, sight gauge, cleanout, and sump drain.
- Filtration: Three 5 micron, full flow tank mounted return filters with electrical clogging indicator. 2 micron pilot oil in-line pressure filter
- Diagnostic Ports Provided for system, load sense, and pilot pressure

## OPTIONAL EQUIPMENT

- Jibs
  - o Heavy lift jib:
    - Total Length: 12.5ft (3.8m) • Offset Angles: 20° & 40°
    - Max. Lifting Height: 166.5 ft (50.7 m)
  - o Main jib:
    - Total Length: 33.5ft (10.2m) • Offset Angles: 20° & 40°
    - Max. Lifting Height: 187 ft (57.2 m)
  - o Fly jib:
    - Total Length: 59.1ft (18.0m) • Offset Angles: 20° & 40°
    - Max. Lifting Height: 213 ft (65.1 m)
  - o Long jib:
    - Total Length: 105 ft (32.0 m) • Offset Angles: 20° & 40°
    - Max. Lifting Height: 259 ft (79.0 m)
- Hook blocks
  - o 130 ton (120t) hook block – Six 18 inch (457 mm) steel sheaves, swivel hook & safety latch
  - o 99 ton (90t) hook block - Five 18 inch (457mm) steel sheaves, swivel hook & safety latch
  - o 70 ton (64t) hook block – Three 18 inch (457 mm) steel sheaves, swivel hook & safety latch
  - o 27 ton (25t) hook block – One 18 inch (457 mm) steel sheave, swivel hook & safety latch
- Overhaul ball – 13.8 ton (12.5t) with swivel hook & safety latch
- Track Shoes: 36 inch (900 mm) flat shoe
- 360 degree house lock. Activated from the operator's cab.
- Tool Circuit: Provides 5 gpm (23 l/min) and 10 gpm (45 l/min) at 2,500 PSI (176 bar) through a 50 foot (15.2m) twin hose reel with quick disconnect fittings to operate open center tools.
- High Flow Tool Circuit: Provides 45 gpm (170 l/min) at 4800 PSI (330 bar)
- Free Fall Hoists: Winches are available in controlled free fall configurations.
- Cold Weather Packages: Cold weather options are available for operation to -40°C (Consult factory for application support)
- Work Platform: Model WP750 – 36 in x 72 in (0.9m x 1.8m) , all steel, welded, two person platform with maximum capacity of 750 lbs (340 kg).
- Full function Radio remote control package
- Automatic central lubrication system.
- Boom mounted anemometer with cab display

## MAIN WINCH AND AUXILIARY WINCH PERFORMANCE

Wire Rope: 22 mm diameter rotation resistant. Line pulls are not based on wire rope strength.

Rope Layer	Max Line Pull (lb)	High Line Speed (ft/min)	Normal Line Speed (ft/min)	Pitch Dia (in)	Layer (ft)	Total (ft)
1	23,560	220.1	130.9	18.9	123.3	123.3
2	21,501	238.5	141.7	20.4	438.4	257.1
3	19,759	256.8	152.8	22.0	472.0	401.0
4	18,282	274.9	163.7	23.6	505.7	555.2
5	17,002	293.2	174.5	25.1	539.3	719.6
6	15,894	311.6	185.3	26.7	572.9	894.2

## MACHINE WEIGHTS

	LB	KG
<b>Standard Crane</b> with 5 section - 155 ft boom, full counterweight, auxiliary winch with wire rope and 36 inch 3-bar semi grouser track shoes	259,993	117,931
<b>Standard Crane</b> with 5 section - 155 ft boom, auxiliary winch with wire rope (Counterweight and track frames removed)	106,466	48,292
<b>Standard Crane</b> with auxiliary winch with wire rope (155 ft boom, boom hoist cylinder, counterweight and track frames removed)	70,666	31,976

## OPTIONAL EQUIPMENT

	LB	KG
Heavy Lift Jib - 12.5 ft (3.8 m)	2,300	1,040
Main Jib - 33.5 ft (10.2 m)	3,303	1,494
Full Jib - 59.1 ft (18.0m)	4,303	1,946
Lattice Jib Insert - 2 Pieces, 23.4 ft (7.14m) each	2,106	954
Auxiliary Nose Sheave	298	135
130 ton (120t) hook block - six sheave	2,257	1,024
70 ton (64t) hook block - three sheave	1,300	588
27 ton (25t) hook block - one sheave	880	398
13.8 ton (12.5t) Overhaul Ball	440	199

# GTC-1300

130 Ton Telescopic Boom Crawler Crane

SPECIFICATION SHEET NO. TMC-DI-02-001-06/20

## DIMENSIONS

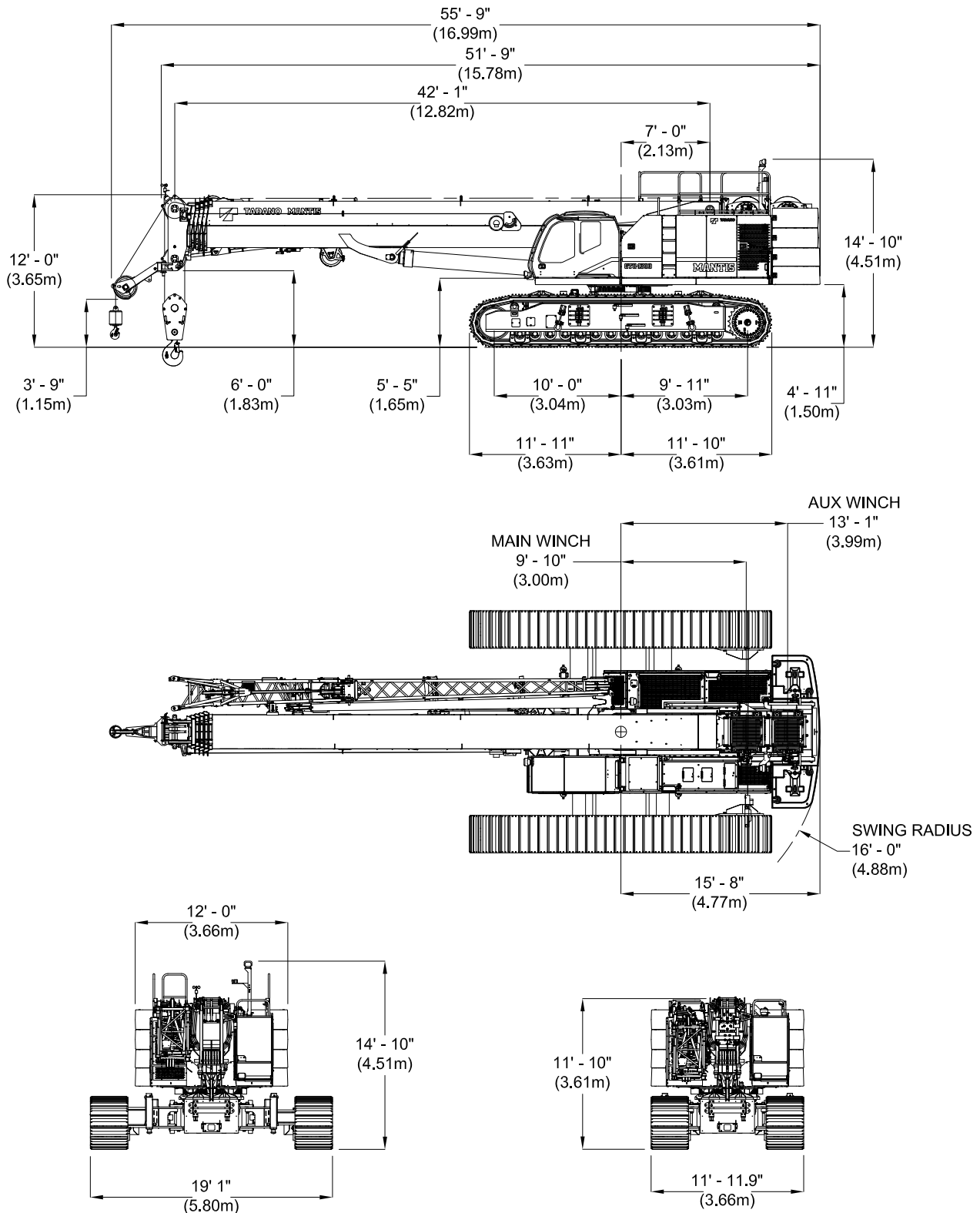

## TRANSPORT DIMENSIONS

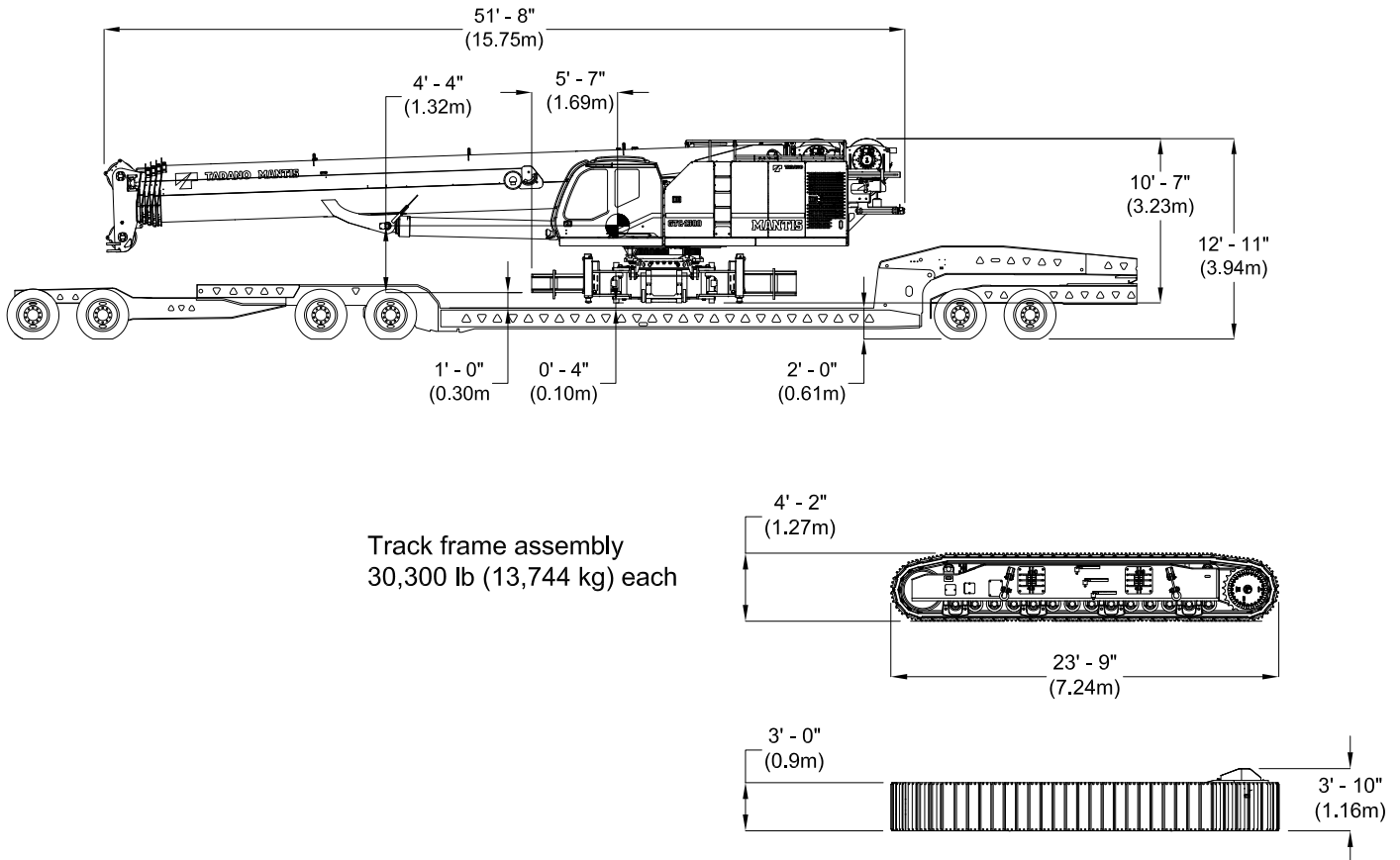

## TRANSPORT PLAN

Item	Weight		Dimensions (L x W x H)	Trailer				
	Lbs	Kg		1	2	3	4	5
Crane Transporter (with 2 winches, Boom, wire rope)	106,726	48,410	51' 8" x 9' 10" x 10' 7"	X				
Left Track Frame	30,300	13,744	23' 9" x 3' 10" x 4' 2"		X			
Right Track Frame	30,300	13,744	23' 9" x 3' 10" x 4' 2"			X		
Counterweight A	23,350	10,590	4' 2" x 12' 0" x 3' 11"				X	
Counterweight B - 1 piece	23,350	10,590	4' 1" x 12' 0" x 1' 6"					X
Counterweight C - 1 piece	5,825	2,642	3' 5" x 3' 8" x 1' 6"					X
Counterweight C - 1 piece	5,825	2,642	3' 5" x 3' 8" x 1' 6"					X
Counterweight C - 1 piece	5,825	2,642	3' 5" x 3' 8" x 1' 6"				X	
Counterweight C - 1 piece	5,825	2,642	3' 5" x 3' 8" x 1' 6"				X	
Counterweight - Carbody - 1 piece	10,000	4,536	3' 1" x 4' 3" x 2' 10"		X			
Counterweight - Carbody - 1 piece	10,000	4,536	3' 1" x 4' 3" x 2' 10"			X		
Jib - Heavy lift	2,300	1,040	14' 5" x 2' 9" x 5' 0"				X	
Jib base section	1,003	454	21' 0" x 2' 4" x 3' 5"				X	
Jib point	1,000	452	25' 7" x 1' 6" x 2' 3"				X	
Jib Insert	1,053	477	23' 5" x 2' 2" x 3' 4"					X
Jib Insert	1,053	477	23' 5" x 2' 2" x 3' 4"					X
Auxiliary Nose Sheave	298	135	4' 1" x 2' 1" x 2' 11"				X	
Hook Block - 130 ton	2,257	1,024	5' 8" x 1' 11" x 1' 11"		X			
Headache Ball - 13 ton	440	199	2' 8" x 1' 0" x 1' 0"			X		
Miscellaneous Items (Crate)	500	227	4' 0" x 3' 0" x 3' 0"				X	
<b>Total Net Weight on Trailer (Lbs)</b>				<b>106726</b>	<b>42557</b>	<b>40740</b>	<b>40101</b>	<b>37106</b>

**TRANSPORT DIMENSIONS - COUNTERWEIGHT**

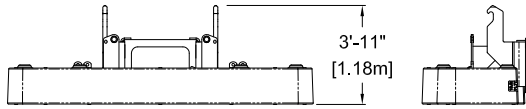
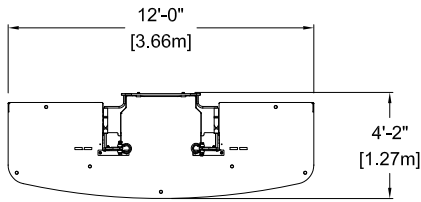

Configuration "A"  
Weight: 23,350 lb (10,590 kg)

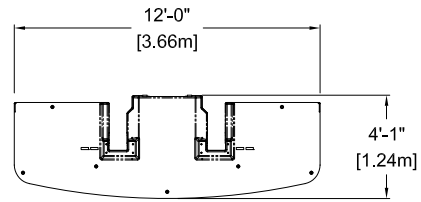

Counterweight Segment "B"  
Weight: 23,350 lb (10,590 kg)

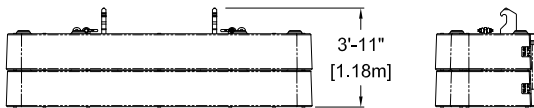
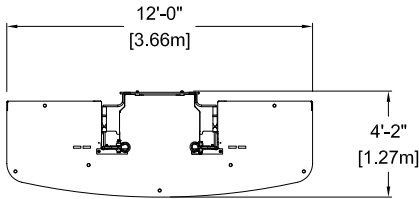

Configuration "B"  
Weight: 46,700 lb (21,180 kg)

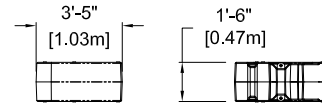
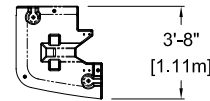

Counterweight Segment "C"  
Weight: 5825 lb (2642 kg)

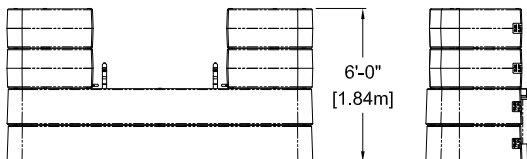
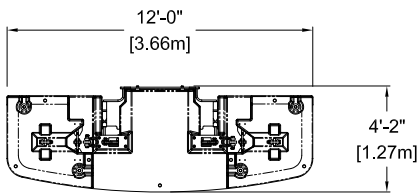

Configuration "C"  
Weight: 70,000 lb (31,750 kg)

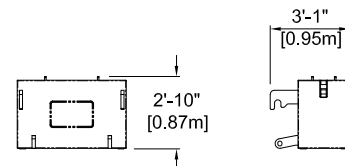
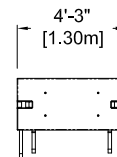

Carbody Counterweight  
2 Pieces  
Weight: 10,000 lbs (4535kg)

**TRANSPORT DIMENSIONS - OPTIONAL LIFTING ATTACHMENTS**

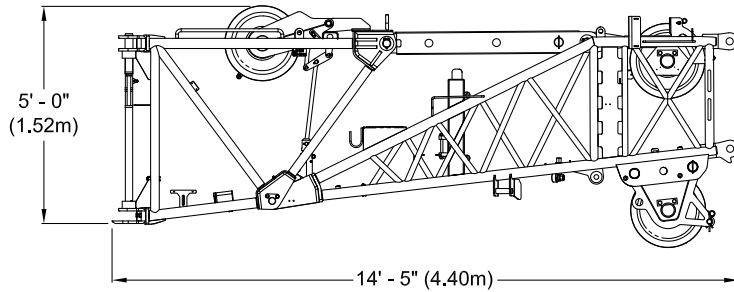

**Heavy Lift Jib**  
Weight: 2,300 lb (1,040 kg)

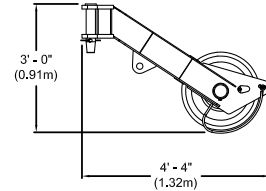

**Auxiliary Nose Sheave**  
Weight: 298 lb (135 kg)

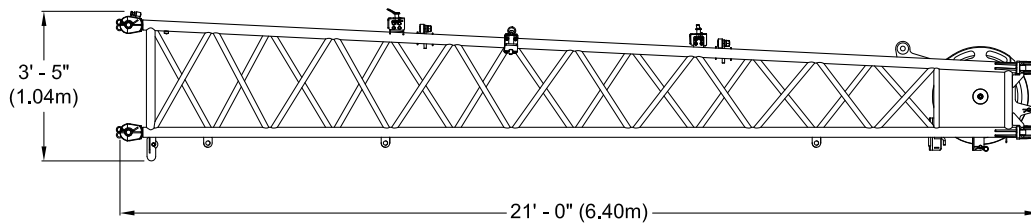

**Main Jib**  
Weight: 1,003 lb (454 kg)

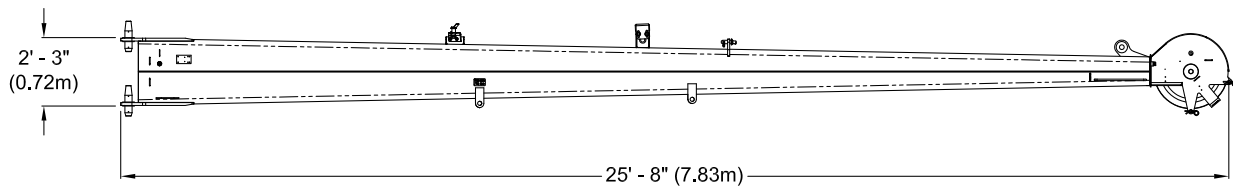

**Fly Jib**  
Weight: 1,000 lb (452 kg)

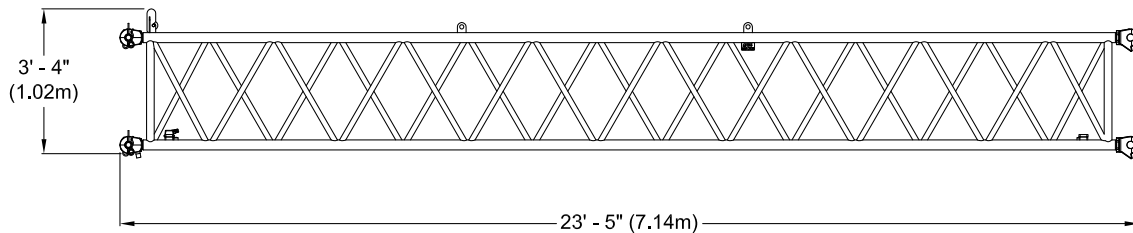

**Lattice Jib Insert**  
Weight: 1,053 lb (477 kg)

**WORKING RANGE DIAGRAM**

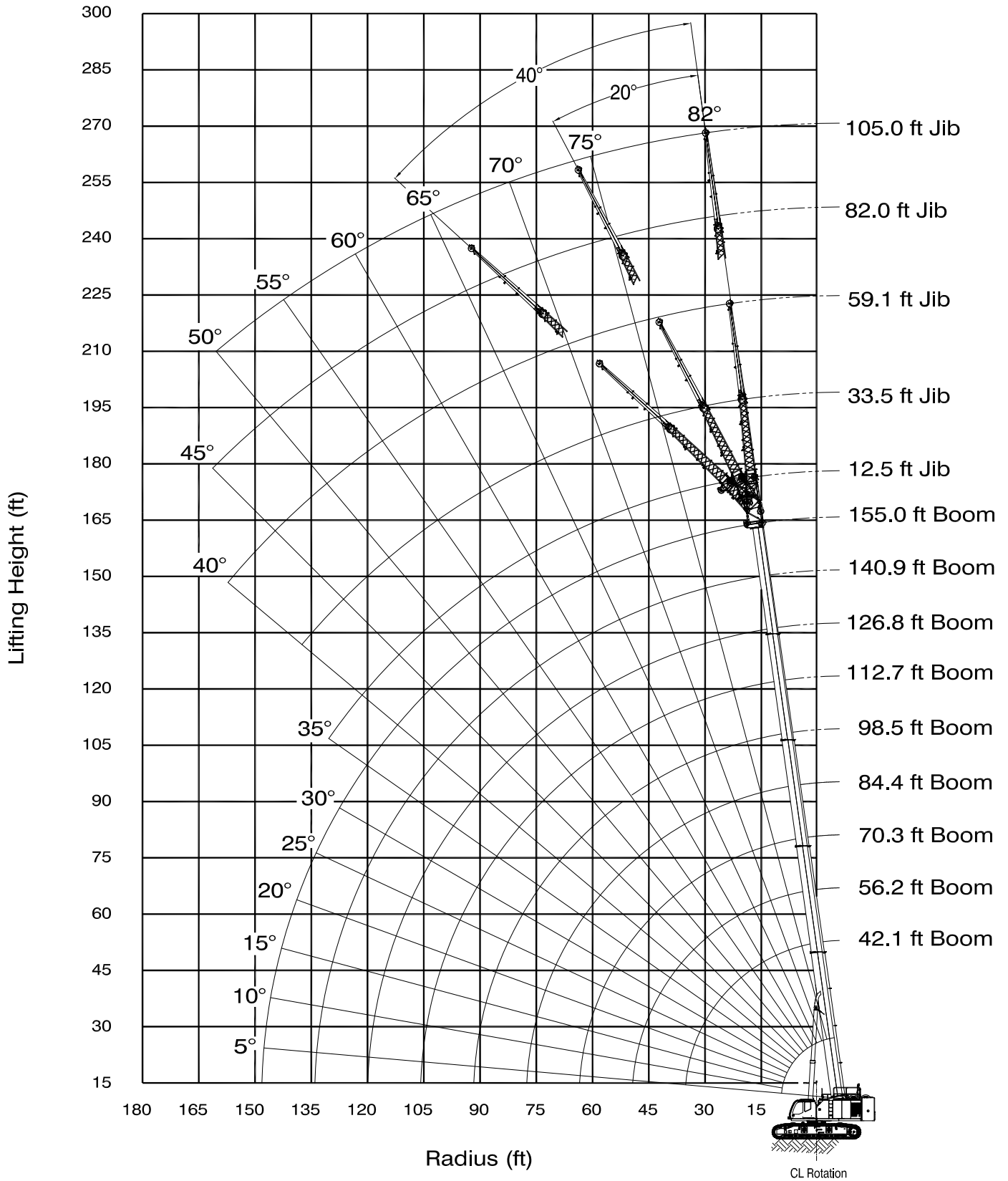



**LOAD CHARTS**

**360 DEGREE RATING - LOADS IN lb x 1000**

<b>MAIN BOOM with TRACKS EXTENDED - 360°</b> <b>UP TO 0.5° SLOPE</b> <b>70,000 lb MAIN COUNTERWEIGHT AND 20,000 lb CARBODY COUNTERWEIGHT</b>										
RADIUS (ft)	MAIN BOOM LENGTH (ft)									RADIUS (ft)
	42.1	56.2	70.3	84.4	98.5	112.7	126.8	140.9	155	
10	264.6	168.7	168.7							10
12	241.2	168.7	149.9	130.4						12
15	211.1	168.7	145.2	124.5	96.8					15
20	164.4	164.2	124.3	106.2	92.1	65.2	65.2			20
25	127.8	127.7	107.6	91.9	80.5	65.2	64.3	49.5		25
30	97.2	96.1	94.8	80.4	70.9	64.6	58.6	49.5	39.0	30
35		75.6	74.7	70.7	62.9	57.8	53.1	48.3	39.0	35
40		61.6	60.8	58.8	56.2	52.1	48.2	44.5	38.6	40
45		51.4	50.6	52.3	46.9	47.0	44.0	40.9	36.2	45
50			42.9	44.6	40.9	41.1	40.2	37.6	33.9	50
55			36.9	38.5	37.2	35.1	36.2	34.8	31.9	55
60			32.0	33.5	34.1	30.4	31.3	32.0	29.8	60
65				29.5	30.4	27.9	27.3	28.1	27.4	65
70				26.1	27.0	25.7	23.9	26.0	25.1	70
75					24.1	23.8	21.7	23.8	22.8	75
80					21.7	22.1	20.1	21.4	20.4	80
85					19.5	20.3	18.7	19.2	18.2	85
90					17.8	18.4	17.4	17.3	16.3	90
95						16.7	16.3	15.6	14.6	95
100						15.3	15.2	14.1	13.1	100
105						14.0	14.3	12.8	11.8	105
110							13.2	11.6	10.6	110
115							12.1	10.5	9.5	115
120								9.5	8.5	120
125								8.7	7.6	125
130								7.9	6.6	130
135									5.6	135
140									4.8	140
145									4.1	145
PARTS OF LINE	12	9	8	6	6	4	4	4	2	PARTS OF LINE

Load chart data is for reference, load charts supplied in the crane cab shall be used for lift planning.

**LOAD CHARTS**

**360 DEGREE RATING - LOADS IN lb x 1000**

<b>MAIN BOOM with TRACKS FULLY EXTENDED - 360°</b> <b>UP TO 4° SLOPE</b> <b>70,000 lb MAIN COUNTERWEIGHT AND 20,000 lb CARBODY COUNTERWEIGHT</b>										
RADIUS (ft)	MAIN BOOM LENGTH (ft)									RADIUS (ft)
	42.1	56.2	70.3	84.4	98.5	112.7	126.8	140.9	155	
10	264.6	168.5	143.5							10
12	239.8	168.5	135.8	106.2						12
15	187.9	168.5	124.6	98.4	52.7					15
20	135.5	135.8	108.8	87.0	52.7	43.8	36.6			20
25	104.3	101.1	94.6	77.5	52.7	43.8	36.6	28.4		25
30	83.5	79.4	74.7	67.6	52.7	43.8	36.6	28.4	24.9	30
35		64.7	61.0	58.3	52.6	43.8	36.6	28.4	24.9	35
40		54.2	51.0	50.8	43.9	43.8	36.6	28.4	24.9	40
45		46.5	43.4	43.4	40.6	37.4	36.6	28.4	24.9	45
50			37.5	37.7	37.3	32.3	32.3	28.4	24.9	50
55			32.9	33.1	33.1	30.0	28.2	28.2	24.9	55
60			29.2	29.2	29.3	27.7	24.8	25.6	24.9	60
65				26.1	26.2	25.6	22.9	24.1	22.4	65
70				23.5	23.5	23.7	21.2	21.6	20.0	70
75					21.3	21.4	19.8	19.5	17.9	75
80					19.3	19.4	18.4	17.6	16.1	80
85					17.7	17.7	17.3	15.9	14.4	85
90					16.4	16.2	16.2	14.4	13.0	90
95						14.9	15.0	13.1	11.7	95
100						13.8	13.8	11.9	10.5	100
105						13.0	12.7	10.9	9.5	105
110							11.8	9.9	8.5	110
115							11.0	9.1	7.6	115
120								8.3	6.7	120
125								7.6	5.8	125
130								7.0	5.0	130
135									4.3	135
140									3.7	140
145									3.2	145
PARTS OF LINE	12	9	8	6	6	4	4	4	2	PARTS OF LINE

Load chart data is for reference, load charts supplied in the crane cab shall be used for lift planning.

**LOAD CHARTS**

**360 DEGREE RATING - LOADS IN lb x 1000**

<b>MAIN BOOM with TRACKS RETRACTED OVER FRONT/REAR UP TO 0.5° SLOPE 70,000 lb MAIN COUNTERWEIGHT AND 20,000 lb CARBODY COUNTERWEIGHT</b>										
RADIUS (ft)	MAIN BOOM LENGTH (ft)									RADIUS (ft)
	42.1	56.2	70.3	84.4	98.5	112.7	126.8	140.9	155	
10	264.6	168.7	168.7							10
12	241.2	168.7	149.9	130.4						12
15	211.1	168.7	145.2	124.5	96.8					15
20	164.4	164.2	124.3	106.2	92.1	65.2	65.2			20
25	127.8	127.7	107.6	91.9	80.5	65.2	64.3	49.5		25
30	103.4	103.2	94.8	80.4	70.9	64.6	58.6	49.5	39.0	30
35		85.3	83.2	71.0	62.9	57.8	53.1	48.3	39.0	35
40		69.3	68.5	63.4	56.2	52.1	48.2	44.5	38.6	40
45		57.8	57.0	53.2	50.5	47.0	44.0	40.9	36.2	45
50			48.3	47.8	44.6	42.6	40.2	37.6	33.9	50
55			41.6	43.1	38.0	38.2	36.7	34.8	31.9	55
60			36.2	37.7	34.1	34.3	33.1	32.0	29.8	60
65				33.2	31.3	29.9	30.0	29.1	27.4	65
70				29.4	29.0	26.1	27.2	26.5	25.1	70
75					26.9	23.8	24.1	24.3	23.0	75
80					24.5	22.1	21.4	22.6	21.1	80
85					22.2	20.6	19.0	21.1	19.4	85
90					20.2	19.2	17.4	19.7	17.9	90
95						18.0	16.3	17.9	16.5	95
100						17.0	15.2	16.2	15.2	100
105						16.0	14.3	14.8	13.8	105
110							13.5	13.5	12.4	110
115							12.7	12.3	11.2	115
120								11.2	10.1	120
125								10.3	9.2	125
130								9.5	8.3	130
135									7.4	135
140									6.5	140
145									5.7	145
PARTS OF LINE	12	9	8	6	6	4	4	4	2	PARTS OF LINE

Load chart data is for reference, load charts supplied in the crane cab shall be used for lift planning.

**LOAD CHARTS**

**360 DEGREE RATING - LOADS IN lb x 1000**

<b>MAIN BOOM with TRACKS RETRACTED - OVER SIDE</b> <b>UP TO 1.5° SLOPE</b> <b>70,000 lb MAIN COUNTERWEIGHT AND 20,000 lb CARBODY COUNTERWEIGHT</b>										
RADIUS (ft)	MAIN BOOM LENGTH (ft)									RADIUS (ft)
	42.1	56.2	70.3	84.4	98.5	112.7	126.8	140.9	155	
10	*	*	*							10
12	*	*	*	*						12
15	*	*	*	*	*					15
20	*	*	*	*	*	*	*			20
25	70.9	68.9	66.9	67.5	*	*	*	*		25
30	55.0	53.3	51.9	52.8	53.0	*	*	*	*	30
35		42.7	41.5	42.6	43.0	43.5	39.8	39.6	37.8	35
40		35.0	34.0	35.2	35.7	36.3	36.3	34.3	33.0	40
45		29.2	28.2	29.5	30.1	30.7	30.9	29.0	27.7	45
50			23.7	25.0	25.7	26.3	26.6	24.8	23.6	50
55			20.1	21.4	22.1	22.8	23.1	21.3	20.2	55
60			17.2	18.4	19.1	19.8	20.2	18.4	17.4	60
65				15.9	16.6	17.4	17.7	16.0	15.0	65
70				13.8	14.6	15.2	15.6	14.0	12.9	70
75					12.8	13.4	13.8	12.2	11.2	75
80					11.2	11.9	12.3	10.7	9.7	80
85					9.9	10.5	10.9	9.3	8.3	85
90					8.8	9.3	9.7	8.1	7.0	90
95						8.2	8.6	7.0	5.7	95
100						7.3	7.6	5.9	4.5	100
105						6.6	6.8	4.9	3.5	105
110							6.0	3.9	*	110
115							5.2	3.1	*	115
120								2.3	*	120
125								*	*	125
130								*	*	130
135									*	135
140									*	140
145									*	145
PARTS OF LINE	12	9	8	6	6	4	4	4	2	PARTS OF LINE

Load chart data is for reference, load charts supplied in the crane cab shall be used for lift planning.

**LOAD CHARTS**

**360 DEGREE RATING - LOADS IN lb x 1000**

<b>MAIN BOOM with TRACKS FULLY EXTENDED - 360°</b> <b>UP TO 0.5° SLOPE</b> <b>0 lb MAIN COUNTERWEIGHT AND 20,000 lb CARBODY COUNTERWEIGHT</b>										
RADIUS (ft)	MAIN BOOM LENGTH (ft)									RADIUS (ft)
	42.1	56.2	70.3	84.4	98.5	112.7	126.8	140.9	155	
10	252.9	168.7	168.7							10
12	208.0	168.7	149.9	130.4						12
15	163.0	163.0	145.2	124.5	96.8					15
20	92.8	91.4	89.9	84.1	80.3	65.2	65.2			20
25	61.2	60.4	59.5	61.5	62.5	59.0	54.1	49.5		25
30	44.0	43.4	42.7	44.7	45.8	46.8	46.6	42.6	39.0	30
35		32.6	32.1	34.0	35.1	36.1	36.6	33.6	30.9	35
40		25.2	24.8	26.6	27.7	28.8	29.3	27.0	24.7	40
45		19.9	19.4	21.2	22.3	23.3	23.9	22.0	19.9	45
50			15.4	17.1	18.2	19.2	19.8	18.1	16.2	50
55			12.2	13.9	15.0	16.0	16.5	14.9	13.1	55
60			9.7	11.3	12.3	13.3	13.9	12.3	10.6	60
65				9.2	10.2	11.2	11.7	10.1	8.5	65
70				7.4	8.4	9.3	9.9	8.3	6.7	70
75					6.9	7.8	8.3	6.7	*	75
80					5.3	6.4	7.0	5.1	*	80
85					4.0	5.0	5.7	*	*	85
90					2.9	3.8	4.5	*	*	90
95						2.8	3.4	*	*	95
100						*	2.5	*	*	100
105						*	*	*	*	105
110							*	*	*	110
115							*	*	*	115
120								*	*	120
125								*	*	125
130								*	*	130
135									*	135
140									*	140
145									*	145
PARTS OF LINE	12	9	8	6	6	4	4	4	2	PARTS OF LINE

Load chart data is for reference, load charts supplied in the crane cab shall be used for lift planning.

**LOAD CHARTS**

**360 DEGREE RATING - LOADS IN lb x 1000**

AUX NOSE SHEAVE with TRACKS FULLY EXTENDED - 360°										
UP TO 0.5° SLOPE										
70,000 lb MAIN COUNTERWEIGHT AND 20,000 lb CARBODY COUNTERWEIGHT										
RADIUS (ft)	MAIN BOOM LENGTH (ft)									RADIUS (ft)
	42.1	56.2	70.3	84.4	98.5	112.7	126.8	140.9	155	
10	28.0	28.0	28.0							10
12	28.0	28.0	28.0	28.0						12
15	28.0	28.0	28.0	28.0	28.0					15
20	28.0	28.0	28.0	28.0	28.0	28.0	28.0			20
25	28.0	28.0	28.0	28.0	28.0	28.0	28.0	28.0		25
30	28.0	28.0	28.0	28.0	28.0	28.0	28.0	28.0	28.0	30
35		28.0	28.0	28.0	28.0	28.0	28.0	28.0	28.0	35
40		28.0	28.0	28.0	28.0	28.0	28.0	28.0	28.0	40
45		28.0	28.0	28.0	28.0	28.0	28.0	28.0	28.0	45
50			28.0	28.0	28.0	28.0	28.0	28.0	28.0	50
55			28.0	28.0	28.0	28.0	28.0	28.0	28.0	55
60			28.0	28.0	28.0	28.0	28.0	28.0	28.0	60
65				28.0	28.0	27.0	28.0	28.0	27.3	65
70				26.9	27.5	24.7	24.6	25.4	25.0	70
75					24.9	22.9	21.8	23.5	23.0	75
80					22.4	21.3	19.5	21.8	20.6	80
85					20.2	19.8	18.1	19.8	18.5	85
90					18.3	18.5	16.9	17.9	16.6	90
95						17.2	15.8	16.2	14.9	95
100						15.7	14.8	14.7	13.4	100
105						14.4	13.9	13.3	12.1	105
110							13.1	12.1	10.8	110
115								11.0	9.7	115
120								10.0	8.8	120
125								9.1	7.8	125
130								8.3	6.9	130
135									6.0	135
140									5.2	140
145									4.4	145
PARTS OF LINE	2	2	2	2	2	2	2	2	2	PARTS OF LINE

Load chart data is for reference, load charts supplied in the crane cab shall be used for lift planning.

**LOAD CHARTS**

**360 DEGREE RATING - LOADS IN lb x 1000**

12.5 ft JIB with TRACKS FULLY EXTENDED - 360°																
UP TO 0.5° SLOPE																
70,000 lb MAIN COUNTERWEIGHT AND 20,000 lb CARBODY COUNTERWEIGHT																
RADIUS (ft)	MAIN BOOM LENGTH (ft)															RADIUS (ft)
	42.1			112.7			126.8			140.9			155			
	0°	20°	40°	0°	20°	40°	0°	20°	40°	0°	20°	40°	0°	20°	40°	
10	88.2	72.1														10
12	88.2	72.0	55.6													12
14	88.2	68.3	54.9													14
16	88.2	64.9	53.1													16
18	83.0	61.9	51.4													18
20	77.8	59.3	49.9													20
22	73.2	56.9	48.5													22
24	69.1	54.7	47.3		34.9											24
26	65.6	52.8	46.2	37.3	34.9	31.3										26
28	62.4	51.1	45.3	36.5	34.1	31.3	31.9	29.4								28
30	59.5	49.5	44.4	36.4	33.0	30.6	30.8	29.4	26.8		27.4					30
35	53.4	46.2	42.9	33.5	30.6	28.6	29.8	27.6	25.9	27.5	26.8	24.2		24.4		35
40	48.8	43.8		31.1	28.7	26.9	27.6	25.7	24.3	26.9	25.0	23.7	24.5	24.1	21.9	40
45	45.4	42.9		29.0	26.9	25.4	25.6	24.1	22.9	25.1	23.5	22.3	24.1	22.6	21.5	45
50				26.7	25.4	24.1	23.6	22.7	21.6	23.5	22.1	21.1	22.7	21.4	20.4	50
55				24.7	24.1	23.0	21.8	21.4	20.5	21.9	21.0	20.1	21.5	20.3	19.4	55
60				22.9	22.6	22.0	20.2	20.1	19.5	20.4	19.9	19.1	20.2	19.3	18.5	60
65				21.3	21.1	20.9	18.8	18.7	18.6	19.1	18.9	18.3	18.9	18.4	17.7	65
70				19.9	19.7	19.6	17.5	17.4	17.4	17.9	17.7	17.5	17.8	17.6	17.0	70
75				18.6	18.4	18.4	16.4	16.3	16.2	16.8	16.7	16.6	16.8	16.6	16.3	75
80				17.4	17.3	17.2	15.3	15.3	15.2	15.8	15.7	15.7	15.9	15.7	15.7	80
85				16.4	16.3	16.2	14.4	14.3	14.3	14.9	14.8	14.7	15.0	14.9	14.8	85
90				15.4	15.3	15.3	13.5	13.5	13.4	14.1	14.0	14.0	14.0	14.1	14.1	90
100				13.1	13.2		11.6	11.7	11.8	12.2	12.5	12.5	10.9	11.2	11.4	100
110				10.8	10.8		9.9	9.9		9.6	9.8	9.9	8.2	8.5	8.7	110
120							8.4	8.4		7.3	7.5		5.6	5.9	6.1	120
130							7.2			5.2	5.4		3.5	3.8		130
140										3.5	3.6		1.8	1.9		140
PARTS OF LINE	6	6	6	3	3	3	2	2	2	2	2	2	2	2	2	PARTS OF LINE

Load chart data is for reference, load charts supplied in the crane cab shall be used for lift planning.

**LOAD CHARTS**

**360 DEGREE RATING - LOADS IN lb x 1000**

33.5 ft JIB with TRACKS FULLY EXTENDED - 360°																
UP TO 0.5° SLOPE																
70,000 lb MAIN COUNTERWEIGHT AND 20,000 lb CARBODY COUNTERWEIGHT																
RADIUS (ft)	MAIN BOOM LENGTH (ft)															RADIUS (ft)
	42.1			112.7			126.8			140.9			155			
	0°	20°	40°	0°	20°	40°	0°	20°	40°	0°	20°	40°	0°	20°	40°	
10	33.1															10
12	33.1															12
14	33.1															14
16	33.1															16
18	33.1	32.4														18
20	33.1	32.4														20
22	33.1	30.8														22
24	33.1	29.3		29.5												24
26	33.1	27.9	20.5	29.5			24.5									26
28	33.1	26.7	20.5	29.5			24.5									28
30	33.1	25.6	20.4	29.5			24.5			23.1						30
35	30.2	23.1	19.0	29.3	22.6		24.5			23.1			19.0			35
40	26.6	21.1	17.9	26.9	22.0		22.7	19.2		23.1			19.0			40
45	23.7	19.5	16.9	24.8	20.6	17.6	21.1	18.8		21.9	17.7		19.0			45
50	21.3	18.1	16.1	23.1	19.5	17.2	19.8	17.7	15.4	20.4	17.5	15.1	19.0	16.9		50
55	19.4	17.0	15.5	21.6	18.4	16.4	18.6	16.8	15.1	19.2	16.5	14.8	19.0	16.7	14.7	55
60	17.8	16.1	15.2	20.3	17.5	15.7	17.5	15.9	14.4	18.1	15.7	14.2	18.1	15.9	14.6	60
65	16.5	15.5		19.2	16.6	15.1	16.6	15.1	13.8	17.1	14.9	13.6	17.2	15.2	13.9	65
70				18.1	15.9	14.5	15.7	14.4	13.2	16.2	14.2	13.0	16.3	14.5	13.4	70
75				17.2	15.2	13.9	14.8	13.7	12.7	15.4	13.6	12.5	15.5	13.9	12.9	75
80				16.2	14.6	13.4	13.9	13.2	12.2	14.6	13.1	12.1	14.6	13.4	12.4	80
85				15.3	14.0	13.0	13.1	12.6	11.8	13.8	12.6	11.7	13.8	12.9	11.9	85
90				14.4	13.5	12.6	12.3	12.1	11.4	13.1	12.1	11.3	13.1	12.4	11.5	90
100				12.8	12.6	11.9	11.0	11.3	10.7	11.7	11.3	10.6	11.9	11.6	10.8	100
110				11.0	11.2	11.4	9.5	10.1	10.1	10.6	10.5	10.0	9.8	10.6	10.2	110
120				9.6	9.8		8.2	8.7	9.0	8.7	9.5	9.5	7.5	8.6	9.2	120
130				8.4	8.5		7.1	7.5		6.8	7.6	8.0	5.4	6.4	7.1	130
140							6.2	6.5		5.0	5.7		3.6	4.5	5.0	140
150										3.6	4.1		2.1	2.8	3.2	150
165										1.9						165
PARTS OF LINE	2	2	2	2	2	2	2	2	2	2	2	2	1	1	1	PARTS OF LINE

Load chart data is for reference, load charts supplied in the crane cab shall be used for lift planning.



**LOAD CHARTS**

**360 DEGREE RATING - LOADS IN lb x 1000**

59.1 ft JIB with TRACKS FULLY EXTENDED - 360°																
UP TO 0.5° SLOPE																
70,000 lb MAIN COUNTERWEIGHT AND 20,000 lb CARBODY COUNTERWEIGHT																
RADIUS (ft)	MAIN BOOM LENGTH (ft)															RADIUS (ft)
	42.1			112.7			126.8			140.9			155			
	0°	20°	40°	0°	20°	40°	0°	20°	40°	0°	20°	40°	0°	20°	40°	
10																10
12																12
14	15.0															14
16	15.0															16
18	15.0															18
20	15.0															20
22	15.0															22
24	15.0															24
26	15.0															26
28	15.0															28
30	15.0			11.9												30
35	15.0	11.3		11.9			11.0									35
40	13.9	10.8		11.9			11.0			10.6						40
45	12.7	10.0		11.9			11.0			10.6			10.1			45
50	11.6	9.4	7.7	11.9	9.5		11.0			10.6			10.1			50
55	10.7	8.8	7.7	11.9	9.5		11.0	9.0		10.6			10.1			55
60	9.9	8.3	7.3	11.9	9.5		11.0	9.0		10.6	9.0		10.1			60
65	9.2	7.8	7.0	11.9	9.1	7.1	11.0	9.0		10.6	9.0		10.1	8.0		65
70	8.6	7.5	6.7	11.9	8.8	7.1	11.0	8.8	6.6	10.6	8.8		10.1	8.0		70
75	8.1	7.1	6.5	11.4	8.5	7.1	11.0	8.5	6.6	10.6	8.6	6.6	10.1	8.0		75
80	7.7	6.8	6.4	10.9	8.2	6.9	11.0	8.2	6.6	10.6	8.3	6.6	10.1	8.0	6.0	80
85	7.2	6.5	6.3	10.5	7.9	6.7	10.6	8.0	6.6	10.6	8.1	6.6	10.1	8.0	6.0	85
90	6.9	6.4		10.0	7.7	6.6	10.2	7.8	6.6	10.4	7.8	6.6	10.1	7.9	6.0	90
100				9.3	7.3	6.3	9.5	7.3	6.3	9.8	7.4	6.4	9.9	7.5	6.0	100
110				8.6	6.9	6.1	8.9	7.0	6.1	9.1	7.1	6.2	9.2	7.1	6.0	110
120				8.0	6.6	6.0	8.0	6.7	6.0	8.6	6.8	6.0	8.6	6.8	6.0	120
130				7.6	6.3	5.8	7.1	6.4	5.8	7.8	6.5	5.8	6.9	6.5	5.8	130
140				7.0	6.2	5.8	6.1	6.2	5.7	6.7	6.3	5.7	5.0	6.3	5.7	140
150				6.2	6.0		5.3	5.7	5.7	5.2	6.1	5.6	3.5	4.9	5.6	150
165				5.1			4.3	4.5		3.2	4.1	4.5	1.6	2.7	3.4	165
180										1.7	2.2			0.8		180
PARTS OF LINE	1	1	1	1	1	1	1	1	1	1	1	1	1	1	1	PARTS OF LINE

Load chart data is for reference, load charts supplied in the crane cab shall be used for lift planning.

**WP750 WORK PLATFORM ON MAIN JIB RANGE CHART**

360 DEGREE RATINGS - LOADS IN LBS x 1000  
 TRACKS FULLY EXTENDED - FULL COUNTERWEIGHT

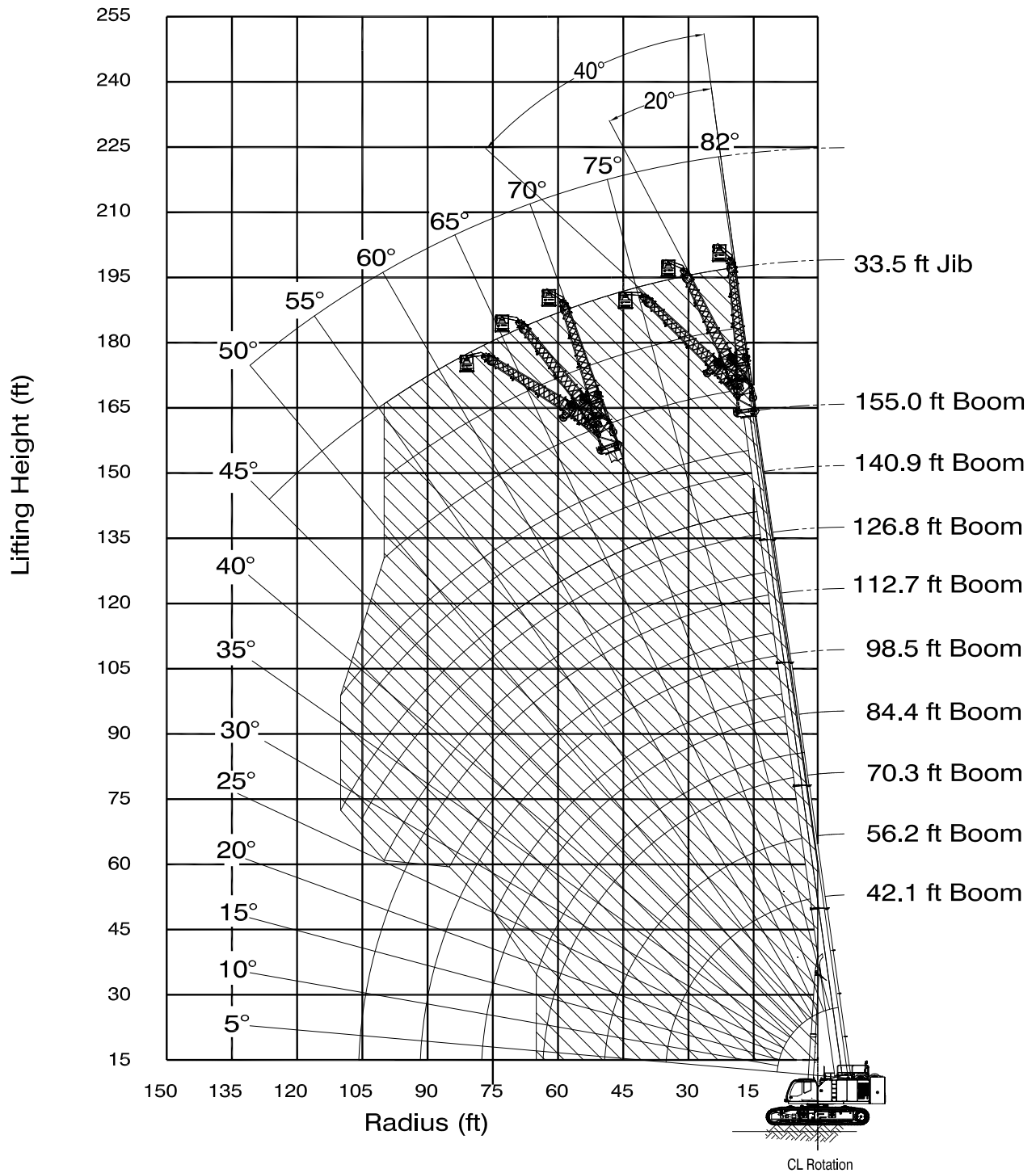

Load chart data is for reference, load charts supplied in the crane cab shall be used for lift planning.

PLEASE READ, UNDERSTAND, AND FOLLOW THE MANUALS FURNISHED WITH THE CRANE (OPERATORS AND SAFETY) AS WELL AS THE CAPACITY LIMITATIONS AND GENERAL CONDITIONS LISTED BELOW PRIOR TO OPERATION OF THE CRANE. FAILURE TO DO SO MAY RESULT IN AN ACCIDENT.

Performance of this TADANO MANTIS crane as manufactured by Tadano Mantis Corporation applies only to machines as originally equipped by manufacturer and in a properly maintained condition. Capacities given are maximum covered by the manufacturer's warranty and are based on a freely suspended load with NO allowance for factors as out-of-level operation (beyond the limits specified on the charts), supporting surface conditions, hazardous surroundings, experience of personnel, etc. The operator shall establish practical working loads based on prevailing operating conditions, such as, but not limited to the above.

The crane meets the requirements of ASME B30.5. Structure and Stability have been tested in accordance with SAE J1063 and SAE J765, respectively.

Maximum admissible wind velocity for working with telescopic boom is 20 mph. Consult TADANO MANTIS for ratings at higher wind speeds.

Side pull on boom is extremely dangerous and must be avoided.

DO NOT exceed manufacturers maximum specified reeving.

Boom angle/boom length relationships given are an approximation of the resulted load radius, which should be an accurate measurement. Boom height dimensions are measured from ground to center of lower boom head sheave.

It is permissible to attempt to telescope boom with a load within the limits of rated capacities. However, boom angle system hydraulic pressure, and/or boom lubrication may affect operation.

It is permissible to travel with loads within the rated capacity of the crane. Travel speeds should be greatly reduced to reflect terrain limitations and minimize dynamic loads applied to the crane structure.

Lifting capacities are shown in metric tons.

The weight of load handling devices such as hook blocks, slings, etc., must be considered as part of the load and must be deducted from the lifting capacities.

The lifting capacities for the telescopic boom apply to a crane with no boom extensions being stowed or mounted on the crane.

The working radius is the horizontal distance from the center of rotation to the center of the freely suspended, non-oscillating load.

Lifting capacities are for reference only. Load charts supplied with the crane should be used for lift planning.

The above remarks are for basic information only and the operator's manual must be consulted before operating this crane. All data and performances refer to the standard crane. The addition of optional and other equipment may affect the performance of the crane.

Load moment indicating and anti-two block systems are operator aids and must never be used in lieu of job site lift planning calculations by the operator which must take into account ground conditions, weather and all other environmental factors prevailing at the time of the lift. Specifications are subject to change at any time without prior notice and are for factory installation at the time of original manufacture. Illustrations and photographs may show optional equipment. Supersedes all previous issues.

# TADANO MANTIS CORPORATION

1705 Columbia Avenue • Franklin, TN 37064 USA • Toll-Free: 1-800-272-3325 • Fax: 615-790-6803 • [mantiscranes.com](http://mantiscranes.com)

## TADANO Ltd., International Division

4-12, Kamezawa 2-chome,  
Sumida-Ku, Tokyo 130-0014, Japan

Tel: +81 3 3621 7750

Fax: +81 3 3621 7785

E-mail: [info@tadano.com](mailto:info@tadano.com)

[www.tadano.com](http://www.tadano.com)

SPECIFICATION SHEET NO. TMC-DI-02-001-06/20