

SENEBOGEN



128 kW



40 t



43 m



MAX CAB

643 R

Teleskopkran
Telescopic Crane



Zentrale Messpunkte zur einfachen und schnellen Überprüfung der gesamten Hydraulikanlage
Central measuring points for simple and quick inspection of the entire hydraulic system



Unterwagen - hydraulisch teleskopierbar, sehr robuste Konstruktion mit sehr starkem Laufwerk - optional Flachbodenplatten
Undercarriage - hydraulically extendable, very robust duty cycle design with extra strong crawlers - optional flat shoes

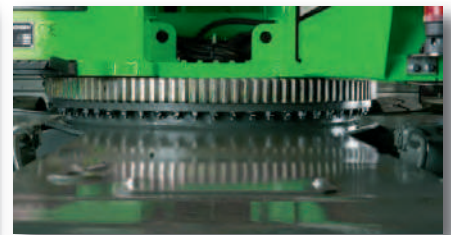

Starker, dynamischer Drehantrieb für schnelle Arbeitsspiele
Strong, dynamic swing drive for fast working cycles

The new dimension of lifting

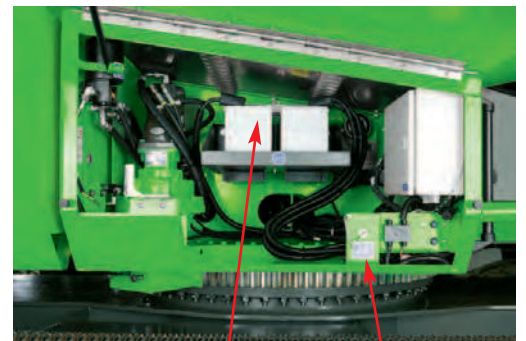

Batterie
 Hervorragende Zugänglichkeit zu den Batterien
Battery
 Excellent access to the batteries

Batterietrennschalter und Hauptsicherungen
Battery main switch and main fuses



Eine Kühlbox mit 3-Kreis-Kühlsystem für Ladeluft-, Wasser- und Ölkühlung
A cool box with 3-circuit cooling system for charge air, water and oil cooling



Übersichtlicher Elektroverteiler mit klarer und deutlicher Beschriftung – leichte und schnelle Fehlerdiagnose
Clearly organised electrical distribution with distinct labeling - easy and quick trouble shooting



Täglicher Service bequem und schnell vom Boden aus
Daily service comfortable and fast from the ground

Servicefreundlich

Täglicher Service bequem und schnell vom Boden aus

Service friendly

Daily service comfortable and fast from the ground

SENNEBOGEN HydroClean

schützt die Hydraulikkomponenten - senkt Wartungs- und Reparaturkosten

SENNEBOGEN HydroClean

protects the hydraulic components, reduces maintenance and repair costs

Starker 6-Zylinder Diesel-Motor mit 128 kW in TIER III Technologie

Strong 6-cylinder diesel engine with 128 kW in TIER III technology

Kühlbox

Die Kühler sind nebeneinander Side by Side angeordnet – keine Verschmutzung zwischen den Kühlern

Cool box

Radiators are arranged side by side - no contamination between the radiators

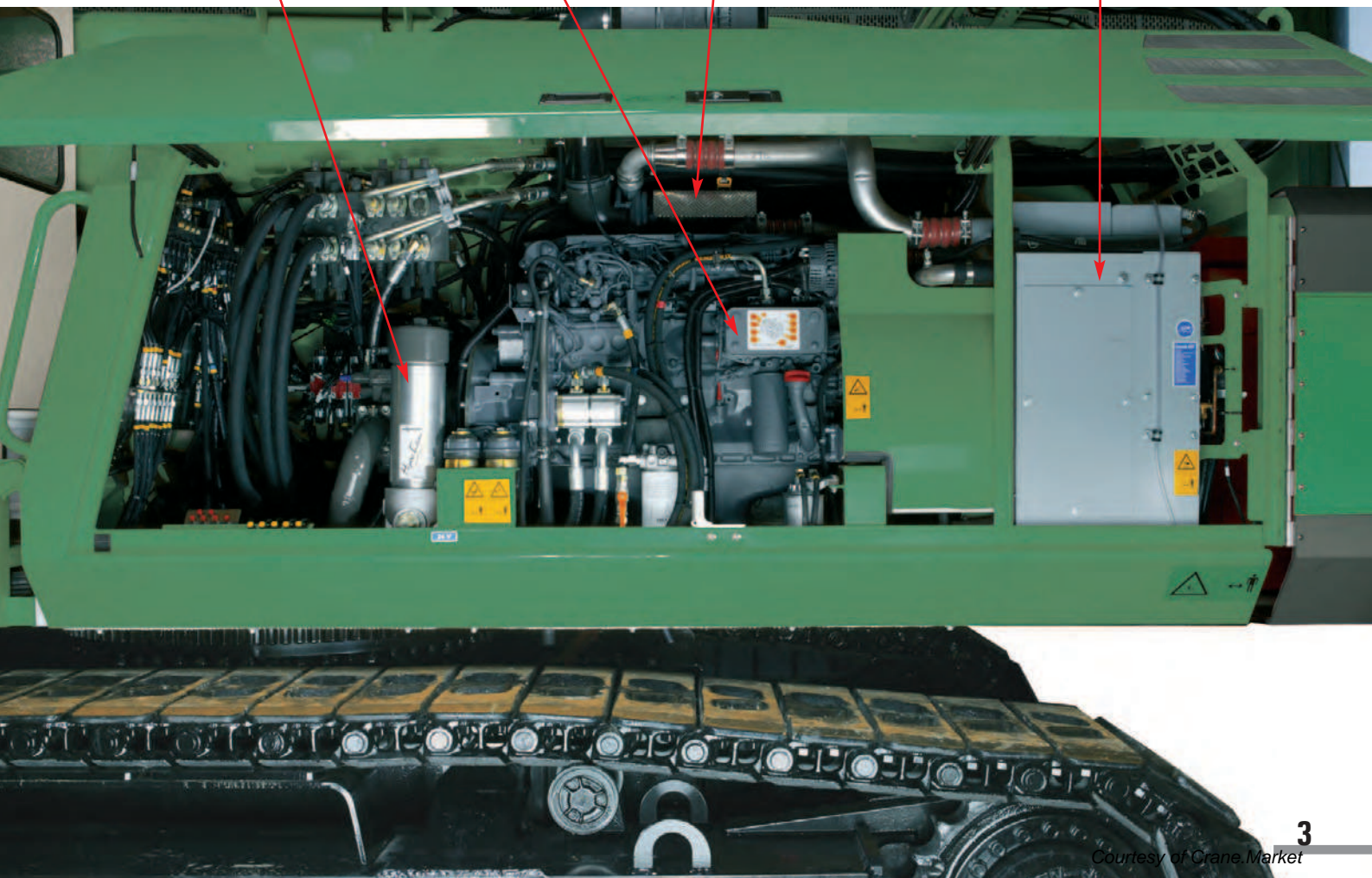

Technische Daten

Diesel-Motor

Leistung	128 kW/174 PS bei 2000 min⁻¹
Model	Deutz TCD 2012 L06 2V- TIER III
Direkteinspritzung, turboaufgeladen, Ladeluftkühlung, emissionsreduziert	
Kühlung	wassergekühlt
Luftfilter	Trockenfilter mit Vorabscheider, automatischer Staubaustrag, Haupt- und Sicherheitselement, Verschmutzungsanzeige
Kraftstofftankinhalt	300 l
Elektrische Anlage	24 V
Batterien	2 x 110 Ah, Hauptschalter

Hydraulik-System

Load Sensing/LUDV Hydrauliksystem für Arbeitsfunktionen und Fahrfunktion

Pumpentyp	Verstell-Kolbenpumpe in Schrägscheibenbauart Lastdruckunabhängige Volumensteuerung für gleichzeitige, unabhängige Steuerung der Arbeitsfunktionen
Pumpenregelung	Nullhubregelung, Bedarfsstromsteuerung - die Pumpen fördern nur so viel Öl, wie auch tatsächlich verbraucht wird, Druckabscheidung

Fördermengen max. **280 l/min**

Betriebsdruck max. **330 bar**

Separater Hydraulikkreis für Drehwerk

Pumpentyp	Zahnradpumpe
Fördermengen max.	35 l/min
Betriebsdruck max.	240 bar
Filtration	Hochleistungsfiltration mit Langzeitwechselintervall SENNEBOGEN HydroClean Feinfiltersystem mit Wasserabscheidung, optional
Kühlung	Sehr großdimensionierte Kühleinheit

Hydrauliktank **440 l**

Steuerung Proportionale, feinfühlig hydraulische Ansteuerung der Bewegungen, 2 Servo Joysticks für die Arbeitsfunktionen, Zusatzfunktionen über Schalter und Fußpedale

Alle Hydraulikkreise sind mit Sicherheitsventilen abgesichert

Hohe Energie-Effizienz durch großdimensionierte Hydraulikventile und Leitungen

Hydraulikspeicher für Notablass der Ausrüstung bei Motorstillstand

Zentrale Messanschlüsse für Hydrauliktest

Rohrbruchsicherheitsventile im Wippzylinder

Rohrbruchsicherheitsventile im Teleskopzylinder

Drehwerk

Kompaktplanetengetriebe mit Schrägachsen-Hydraulikmotor, integrierten Bremsventilen

Feststellbremse Lamellenbremse, über Federn wirkend

Drehkranz starker Kugeldrehkranz, abgedichtet

Drehgeschwindigkeit 0-2 min⁻¹, stufenlos

Oberwagen

Bauart	Verwindungssteife Kastenbauweise, präzisionsbearbeitet, Stahlbüchsen für Auslegerlagerung, klare, sehr servicefreundliche Konzeption, in Längsrichtung eingebauter Motor
--------	--

Kühlsystem

Kompakte 3-Kreis-Kühlereinheit mit großer Kühlleistung

Arbeitsausrüstung

Konstruktion	Jahrzehntelange Erfahrung und modernste Computersimulation garantieren ein Höchstmaß an Stabilität und Lebensdauer
Teleskopausleger	4-teilig mit Rollenkopf, hydr. teleskopierbar 23, 4 m oder 30 m
Spitzenausleger	6,5 m bzw. 13 m Klappspitze, sehr schnell und ohne Hilfsgerät aufrüstbar, bei Nichtgebrauch wird dieser seitlich am Grundausleger verriegelt
Hubwinde	Antrieb über Schrägachsen Hydraulikmotor mit Kompaktplanetengetriebe, Zugkraft (1. Lage) 40 kN, Seilgeschwindigkeit 0-95 m/min. Seildurchmesser 14 mm, 2. Hubwinde optional
Sicherheitsbremse Kransicherheit	Lamellenbremse über Federn wirkend Neuste Generation der Lastmomentüberwachung, übersichtliches Tableau mit Anzeige aller wichtigen Daten, Hubenschalter, Seilablaufsicherung, Überdruckventile- und Rohrbruchsicherungen
Zylinder	Hydraulikzylinder mit hochwertigen Dichtungs- und Führungselementen

Unterwagen

Konstruktion	Sehr starker, hydraulisch teleskopierbarer Raupenunterwagen, mit integrierten, geschützten Antriebsgetrieben
Fahrtrieb	Starker Fahrtrieb mit 2-Stufen Verstellhydraulikmotor mit direkt angebauten automatisch wirkenden Bremsventil und Kompaktplanetengetriebe je Fahrwerksseite.
Parkbremse	Lamellenbremse über Federn wirkend
Laufwerk	Wartungsfreies Traktorenlaufwerk mit hydraulischer Kettenspannung, 3-Steg-Bodenplatten, Flachbodenplatten optional
Fahrgeschwindigkeit	0-1,2 / 0-2,7 km/h

Einsatzgewicht

643 R mit Teleausleger 30 m, Spitzenausleger 13 m, 20 t Haken, Winde, 700 mm 3-Steg Bodenplatten

mit Ballast 5,4 t ca. 36.900 kg

mit Ballast 7 t + 4 t ca. 42.500 kg

Das Einsatzgewicht variiert je nach Ausführung und Ausstattung. Technische Änderungen vorbehalten!

Specifications

Diesel engine

Output **128 kW/174 HP at 2000 rpm**
 Model **Deutz TCD 2012 L06 2V -TIER III**
 Direct injection, turbo charged, intercooler, reduced emission

Cooling Water cooled
 Air filter Dry air filter with precleaner, automatic dust Discharge, main and safety element, pollution indicator

Fuel tank **300 l**
 Electric system 24 Volt
 Batteries 2 x 110 Ah, main switch

Hydraulic system

load sensing/LUDV system for working functions and drive function

Hydraulic pump Variable displacement piston pump, swashplate type, load sensing regulation for parallel, independent operation of the working functions

Pump regulation Zero-flow regulation, flow on demand control - the pumps only supplying the required oil, pressure cut off

Oil flow max. **280 l/min**
 Pressure max. **330 bar**

Separate hydraulic circuit for swing operation

Pump type Gear pump
 Oil flow max. **35 l/min**
 Pressure max. **240 bar**
 Filtration High-efficiency filtration with long-time change interval, SENNEBOGEN HydroClean micro filtration with water separation, optional

Cooling Large-sized cooling unit

Hydraulic tank **440 l**
 Steering Proportional, hydraulically and precise control of the hydraulic functions, 2 servo joysticks for operating movements, additional functions through switches and foot pedals

Safety valves for all hydraulic circuits
 High efficiency through well designed hydraulic valves and lines.
 Pressure accumulator for lowering of attachments when engine turned off
 Central pressure test ports
 Safety check valves for boom cylinders
 Safety check valves for telescopic boom cylinders

Slew drive

Compact planetary reduction gear with hydraulic piston motor, integrated brake valves

Parking brake Multi-disc brake, spring-loaded
 Slew bearing Strong ball bearing, sealed
 Slewing speed 0-2 rpm, stepless

Upper carriage

Design Torsion resistant box type design precision machined, steel bushes for the boom pivot.
 Clear, very servicefriendly design longitudinal installation of the engine

Cooling system

Compact 3 circuit cooling system, large sized

Working equipment

Design Decades of experience and state-of-the-art computer simulation guarantee highest stability and durability

Telescopic boom 4-section telescopic boom, full power hydraulically extendable, 23.4 m or 30 m

Folding jib 6.5 m or 13 m length, fast and easy erection, while not using it can be folded at the side of the mainboom

Hoist winch Axial piston hydraulic motor, planetary gear, linepul (1st layer), 40 kN, line speed 0-95 m/min, rope dia. 14 mm, 2. hoist winch optional

Safety brake Spring applied multi disc brake

Crane safety State-of-the-art safe load indicator with clearly laid out display, hoist limit switch, rope limit switch, pressure relief and safety check valves

Cylinders Hydraulic cylinders with high-grade seal and guide system

Undercarriage

Design Very strong, hydraulically extendable crawler undercarriage with integrated, protected drives

Drive system High traction force through 2 speed variable displacement piston motors with directly mounted automatic brake valves and planetary gears at each track side

Parking brake Multi-disc brake, spring loaded

Tracks Maintenance free track type with hydraulic track tensioning system, triple bar shoes. Flat shoes optional

Travel speed 0-1.2 / 0-2.7 km/h

Operating weight

643 R with telescopic boom 30 m, jib 13 m and hook block 20t, 700 mm triple bar shoes

with counterweight 5,4 t approx. 36,900 kg
with counterweight 7 t + 4 t approx. 42,500 kg

Operating weight may vary with different equipment and attachments. Subject to technical modification!

Ausleger / Boom





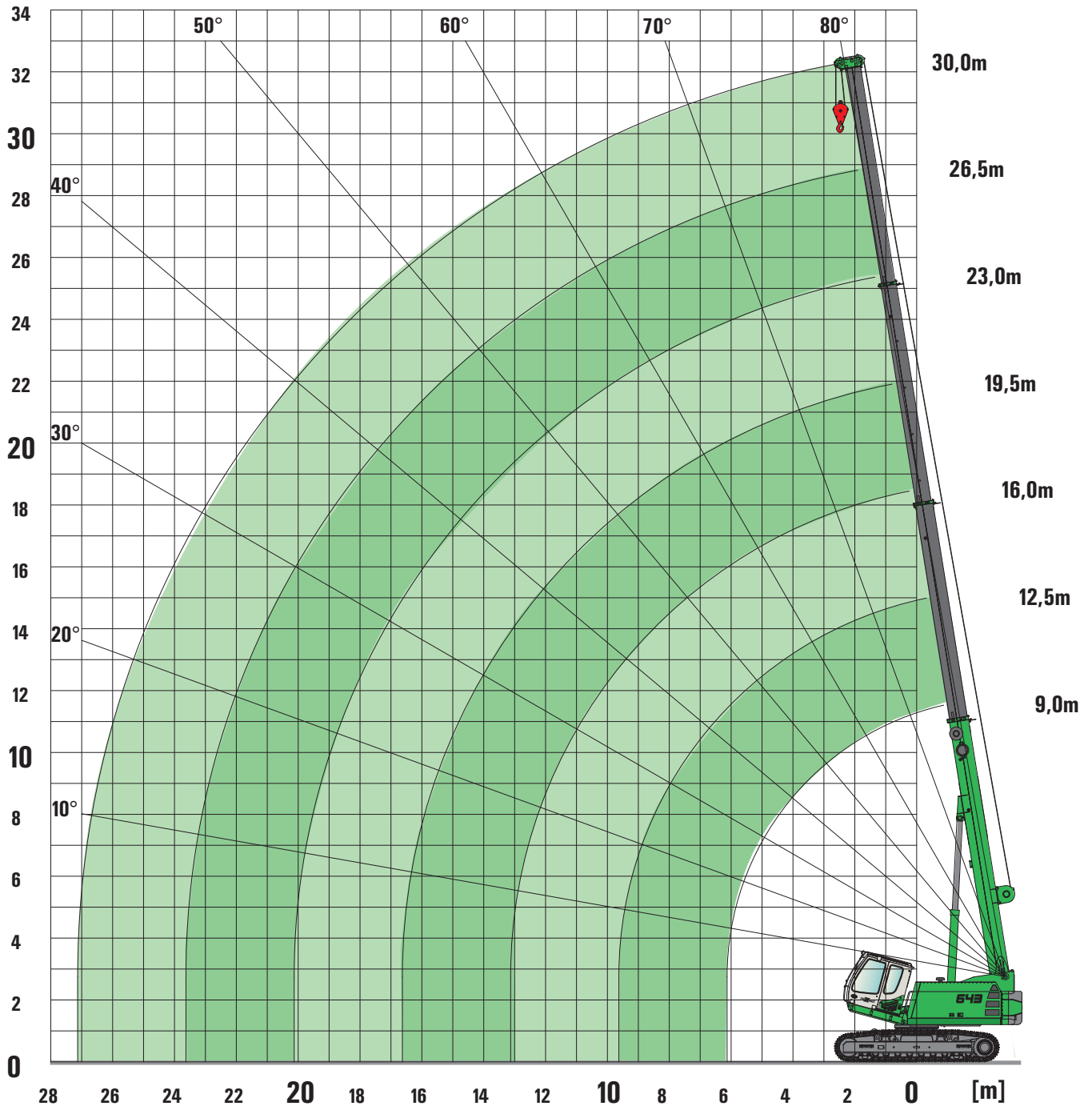

9-30 m



Anmerkung:

- Die angegebenen Traglastwerte gelten für ebenen und festen Stand der Maschine
- Die Traglastwerte sind in Tonnen angegeben und gelten für 360° Schwenkwinkel
- Die Traglastwerte berücksichtigen die Normen DIN 15019.2, ISO 4305 sowie die Kippwinkelmethode (5°)
- Das Gewicht der Lastaufnahmemittel (Haken, Gehänge) ist von den Traglasten abzuziehen
- Die Traglastwerte "Spur 3800" gelten für die maximale Unterwagenspurbreite 3800mm
Die Traglastwerte "Spur 2300" gelten für die minimale Unterwagenspurbreite
- Lastwerte müssen begrenzt oder vermindert werden, um ungünstige Bedingungen zu berücksichtigen, wie weichen oder unebenen Boden, schräge Gefälle, Wind, Seitenlasten, schwingende Lasten, Rucken oder plötzliches Stoppen der Ladungen, Unerfahrenheit des Personals, Fahren mit Last
- Zulässiger Seilzug je Strang bei Kranbetrieb ist bei 14 mm Seildurchmesser 3.500 kg
- Traglasten mit * gekennzeichnet, gelten nur mit Sonderausrüstung.
- Die angegebenen Traglastwerte dienen nur zur Orientierung. Die jeweils gültigen Traglastwerte entnehmen Sie bitte den Tabellen in der Betriebsanleitung

Ausleger / Boom



7 t + 4 t

9-30 m

Ausladung / Radius [m]	Auslegerlänge / Boom length [m]													
	9,0		12,5		16,0		19,5		23,0		26,5		30,0	
2,0	40,0*	40,0*												
3,0	35,0	33,0	20,0	20,0	15,0	15,0	14,0	14,0	11,0	11,0	8,9	8,9	5,0	5,0
4,0	30,2	20,2	20,0	19,9	15,0	15,0	14,0	14,0	11,0	11,0	8,9	8,9	5,0	5,0
5,0	25,5	14,2	20,0	14,0	15,0	13,9	13,3	13,3	11,0	11,0	8,6	8,6	5,0	5,0
6,0	18,6	10,7	18,5	10,5	14,9	10,5	12,0	10,9	10,3	10,3	8,3	8,3	5,0	5,0
7,0	12,2/6,2m	10,2/6,2m	14,3	8,3	13,2	8,2	10,9	8,6	9,5	8,9	7,8	7,8	5,0	5,0
8,0			11,5	6,7	11,4	6,6	9,8	7,0	8,7	7,3	7,4	7,4	5,0	5,0
9,0			9,5	5,5	9,4	5,4	9,0	5,8	7,9	6,1	6,9	6,2	5,0	5,0
10,0			7,5/9,6m	4,9/9,6m	8,0	4,5	8,3	4,9	7,1	5,1	6,4	5,3	5,0	5,0
11,0					6,8	3,7	7,2	4,1	6,5	4,4	5,9	4,5	5,0	4,7
12,0					5,9	3,1	6,2	3,5	5,9	3,7	5,5	3,9	5,0	4,1
13,0					5,0	2,6	5,4	3,0	5,5	3,2	5,1	3,4	4,7	3,5
14,0							4,8	2,6	5,0	2,8	4,8	3,0	4,4	3,1
15,0							4,2	2,2	4,5	2,4	4,5	2,6	4,1	2,7
16,0							3,7	1,9	4,0	2,1	4,2	2,3	3,8	2,4
17,0							3,5/16,6m	1,7/16,6m	3,6	1,8	3,7	2,0	3,6	2,1
18,0									3,2	1,6	3,4	1,7	3,3	1,9
19,0									2,9	1,3	3,0	1,5	3,1	1,6
20,0									2,6	1,1	2,7	1,3	2,9	1,4
21,0									2,5/20,1m	1,1/20,1m	2,5	1,1	2,6	1,3
22,0											2,2	1,0	2,4	1,1
23,0											1,9/23,6m	0,7/23,6m	2,2	0,9
24,0													2,0	0,8
25,0													1,8	0,7
26,0													1,6	0,6
27,0	Spur 3800 Tab.Nr.: 643R-30.0/75/1977/7.0/08.06													
28,0	Spur 2300 Tab.Nr.: 643R-30.0/75/1227/7.0/08.06													
Strangzahl / Parts reeving	10	10	6	6	5	5	4	4	4	4	3	3	2	2
I	0%		50%		100%		100%		100%		100%		100%	
II	0%		0%		0%		25%		50%		75%		100%	
III	0%		0%		0%		25%		50%		75%		100%	



7 t + 4 t

Ausladung / Radius [m]	Auslegerlänge / Boom length [m]													
	9,0		12,5		16,0		19,5		23,0		26,5		30,0	
2,0														
3,0	6,0	6,0	6,0	6,0	6,0	6,0	6,0	6,0	6,0	6,0	6,0	6,0	5,0/3,5m	5,0/3,5m
4,0	6,0	6,0	6,0	6,0	6,0	6,0	6,0	6,0	6,0	6,0	6,0	6,0	5,0	5,0
5,0	6,0	6,0	6,0	6,0	6,0	6,0	6,0	6,0	6,0	6,0	6,0	6,0	5,0	5,0
6,0	6,0	6,0	6,0	6,0	6,0	6,0	6,0	6,0	6,0	6,0	6,0	6,0	5,0	5,0
7,0	6,0/6,7m	6,0/6,7m	6,0	6,0	6,0	6,0	6,0	6,0	6,0	6,0	6,0	6,0	5,0	5,0
8,0			6,0	6,0	6,0	6,0	6,0	6,0	6,0	6,0	6,0	6,0	5,0	5,0
9,0			6,0	5,4	6,0	5,3	6,0	5,7	6,0	6,0	6,0	6,0	5,0	5,0
10,0			6,0	4,4	6,0	4,4	6,0	4,8	6,0	5,0	6,0	5,2	5,0	4,9
11,0			6,0/10,2m	4,2/10,2m	6,0	3,6	6,0	4,0	6,0	4,3	5,8	4,4	5,0	4,6
12,0					5,8	3,0	6,0	3,4	5,8	3,6	5,4	3,8	4,9	4,0
13,0					4,9	2,5	5,3	2,9	5,4	3,1	5,0	3,3	4,6	3,4
14,0					4,3/13,7m	2,1/13,7m	4,7	2,5	4,9	2,7	4,7	2,9	4,3	3,0
15,0							4,1	2,1	4,4	2,3	4,4	2,5	4,0	2,6
16,0							3,6	1,8	3,9	2,0	4,1	2,2	3,7	2,3
17,0							3,1	1,5	3,5	1,7	3,6	1,9	3,5	2,0
18,0							3,0/17,2m	1,4/17,2m	3,1	1,5	3,3	1,6	3,2	1,8
19,0									2,8	1,2	2,9	1,4	3,0	1,5
20,0									2,5	1,0	2,6	1,2	2,8	1,3
21,0									2,2/20,7m	0,8/20,7m	2,4	1,0	2,5	1,2
22,0											2,1	0,9	2,3	1,0
23,0											1,8	0,7	2,1	0,8
24,0											1,7/24,2m	0,6/24,2m	1,9	0,7
25,0													1,7	0,6
26,0													1,5	0,5
27,0	Spur 3800 Tab.Nr.: 643R-30.0/75/1977/7.0/08.06 S													
28,0	Spur 2300 Tab.Nr.: 643R-30.0/75/1227/7.0/08.06 S													
Strangzahl / Parts reeving	2	2	2	2	2	2	2	2	2	2	2	2	2	2
I	0%		50%		100%		100%		100%		100%		100%	
II	0%		0%		0%		25%		50%		75%		100%	
III	0%		0%		0%		25%		50%		75%		100%	

Bei angebaubtem Spitzenausleger am Grundkörper müssen die Traglastwerte reduziert werden:
When the jib is mounted at the basic mainboom the rated loads have to be reduced:

Länge Hauptausleger / Main boom length	[m]	9,0	12,5	16,0	19,5	23,0	26,5	30,0
Traglastreduzierung / reduction of load	[kg]	570	420	330	280	240	210	180

Ausleger / Boom



5,4 t



9-30 m

Ausladung / Radius [m]	Auslegerlänge / Boom length [m]													
	9,0		12,5		16,0		19,5		23,0		26,5		30,0	
2,0	40,0*	40,0*												
3,0	31,7	22,9	20,0	20,0	15,0	15,0	14,0	14,0	11,0	11,0	8,9	8,9	5,0	5,0
4,0	27,1	13,9	20,0	13,7	15,0	13,6	14,0	14,0	11,0	11,0	8,9	8,9	5,0	5,0
5,0	21,3	9,7	20,0	9,5	15,0	9,4	13,3	9,9	11,0	10,2	8,6	8,6	5,0	5,0
6,0	15,4	7,2	15,2	7,0	14,9	6,9	12,0	7,3	10,3	7,6	8,3	7,9	5,0	5,0
7,0	11,9/6,2m	6,8/6,2m	11,7	5,3	11,6	5,3	10,9	5,7	9,5	6,0	7,8	6,2	5,0	5,0
8,0			9,4	4,2	9,3	4,1	9,7	4,5	8,7	4,8	7,4	5,0	5,0	5,0
9,0			7,7	3,3	7,6	3,2	8,0	3,6	7,9	3,9	6,9	4,1	5,0	5,0
10,0			6,8/9,6m	2,8/9,6m	6,3	2,5	6,7	2,9	7,0	3,2	6,4	3,3	5,0	3,5
11,0					5,3	2,0	5,7	2,3	6,0	2,6	5,9	2,8	5,0	2,9
12,0					4,5	1,5	4,9	1,9	5,2	2,1	5,3	2,3	5,0	2,5
13,0					3,8	1,2	4,2	1,5	4,5	1,8	4,7	1,9	4,7	2,1
14,0							3,7	1,2	3,9	1,4	4,1	1,6	4,2	1,7
15,0							3,2	0,9	3,4	1,2	3,6	1,3	3,7	1,5
16,0							2,8	0,7	3,0	0,9	3,2	1,1	3,3	1,2
17,0							2,6/16,6m	0,6/16,6m	2,7	0,7	2,8	0,9	3,0	1,0
18,0									2,3	0,5	2,5	0,7	2,7	0,8
19,0									2,1		2,2	0,5	2,4	0,7
20,0									1,8		2,0		2,1	0,5
21,0									1,8/20,1		1,8		1,9	
22,0											1,6		1,7	
23,0											1,3/23,6		1,5	
24,0													1,4	
25,0													1,2	
26,0													1,1	
27,0	Spur 3800 Tab.Nr.: 643R-30.0/75/1977/5.4/08.06													
28,0	Spur 2300 Tab.Nr.: 643R-30.0/75/1227/5.4/08.06													
Strangzahl / parts reeving	10	10	6	6	5	5	4	4	4	4	3	3	2	2
I	0%		50%		100%		100%		100%		100%		100%	
II	0%		0%		0%		25%		50%		75%		100%	
III	0%		0%		0%		25%		50%		75%		100%	



5,4 t



Ausladung / Radius [m]	Auslegerlänge / Boom length [m]													
	9,0		12,5		16,0		19,5		23,0		26,5		30,0	
2,0														
3,0	6,0	6,0	6,0	6,0	6,0	6,0	6,0	6,0	6,0	6,0	6,0	6,0	5,0/3,5m	5,0/3,5m
4,0	6,0	6,0	6,0	6,0	6,0	6,0	6,0	6,0	6,0	6,0	6,0	6,0	5,0	5,0
5,0	6,0	6,0	6,0	6,0	6,0	6,0	6,0	6,0	6,0	6,0	6,0	6,0	5,0	5,0
6,0	6,0	6,0	6,0	6,0	6,0	6,0	6,0	6,0	6,0	6,0	6,0	6,0	5,0	5,0
7,0	6,0/6,7m	5,5/6,7m	6,0	5,2	6,0	5,2	6,0	5,6	6,0	5,9	6,0	6,0	5,0	5,0
8,0			6,0	4,1	6,0	4,0	6,0	4,4	6,0	4,7	6,0	4,9	5,0	5,0
9,0			6,0	3,2	6,0	3,1	6,0	3,5	6,0	3,8	6,0	4,0	5,0	4,9
10,0			6,0	2,5	6,0	2,4	6,0	2,8	6,0	3,1	6,0	3,2	5,0	3,4
11,0			6,0/10,2m	2,4/10,2m	5,2	1,9	5,6	2,2	5,9	2,5	5,8	2,7	5,0	2,8
12,0					4,4	1,4	4,8	1,8	5,1	2,0	5,2	2,2	4,9	2,4
13,0					3,7	1,1	4,1	1,4	4,4	1,7	4,6	1,8	4,6	2,0
14,0					3,0/13,7m	0,8/13,7m	3,6	1,1	3,8	1,3	4,0	1,5	4,1	1,6
15,0							3,1	0,8	3,3	1,1	3,5	1,2	3,6	1,4
16,0							2,7	0,6	2,9	0,8	3,1	1,0	3,2	1,1
17,0							2,3		2,6	0,6	2,7	0,8	2,9	0,9
18,0							2,2/17,2m		2,2		2,4	0,6	2,6	0,7
19,0									2,0		2,1		2,3	0,6
20,0									1,7		1,9		2,0	
21,0									1,5/20,7m		1,7		1,8	
22,0											1,5		1,6	
23,0											1,2		1,4	
24,0											1,2/24,2m		1,2	
25,0													1,1	
26,0													1,0	
27,0	Spur 3800 Tab.Nr.: 643R-30.0/75/1977/5.4/08.06 S													
28,0	Spur 2300 Tab.Nr.: 643R-30.0/75/1227/5.4/08.06 S													
Strangzahl / Parts reeving	2	2	2	2	2	2	2	2	2	2	2	2	2	2
I	0%		50%		100%		100%		100%		100%		100%	
II	0%		0%		0%		25%		50%		75%		100%	
III	0%		0%		0%		25%		50%		75%		100%	

Bei angebaubtem Spitzenausleger am Grundkörper müssen die Traglastwerte reduziert werden:
When the jib is mounted at the basic mainboom the rated loads have to be reduced:

Länge Hauptausleger Main boom length	[m]	9,0	12,5	16,0	19,5	23,0	26,5	30,0
Traglastreduzierung reduction of load	[kg]	570	420	330	280	240	210	180

643 R - Der kompakte und leistungsfähige Teleskopkran kann auch auf engstem Raum optimal eingesetzt werden - ob auf der Baustelle, im Tunnelbau, in engen innerstädtischen Baustellen oder in Industrieanlagen und Industriehallen.

643 R - The compact and efficient telescopic crane can be put to optimum use also in very confined work spaces - whether on construction sites, in tunneling, on tight inner-city job sites or on industrial premises and in industrial halls.

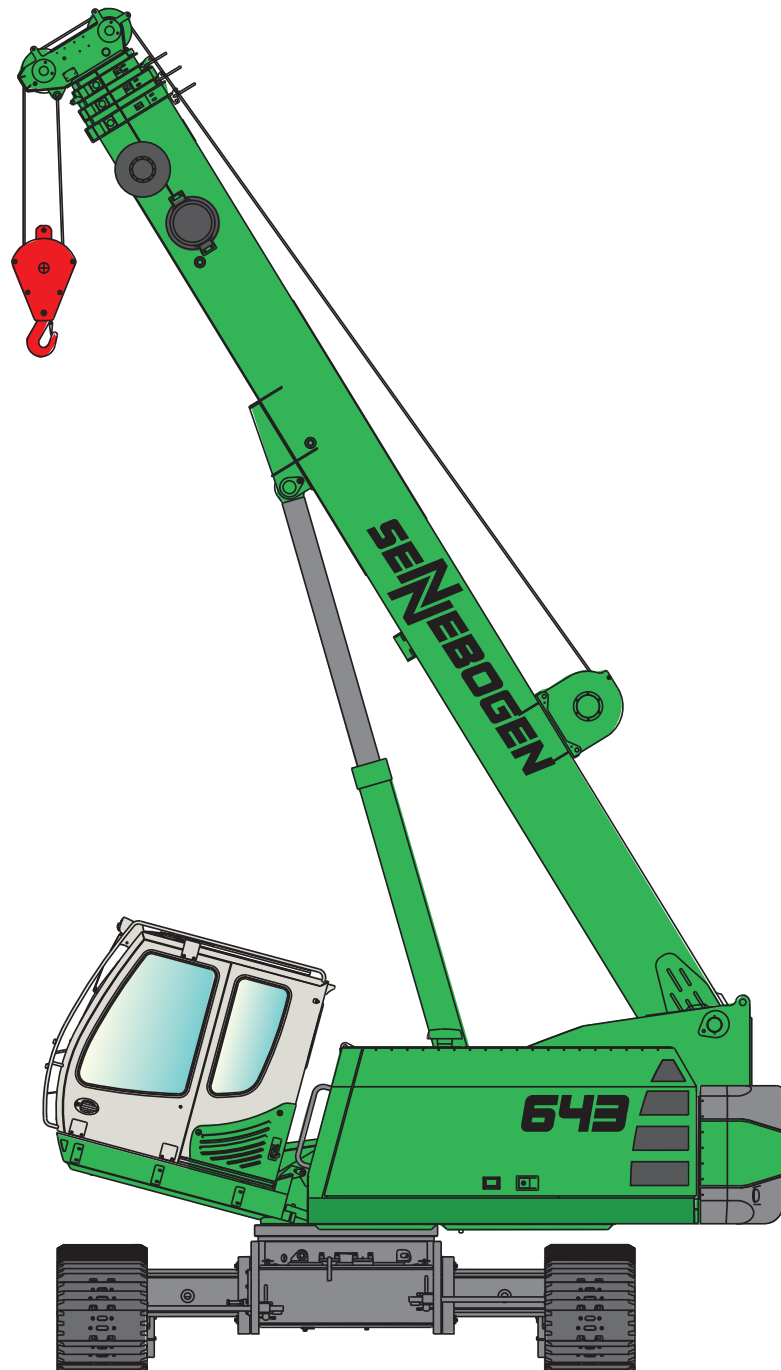

Spitzenausleger/ Folding jib



- ① 6,5 m / 0°
- ② 6,5 m / 40°
- ③ 13 m / 0°
- ④ 13 m / 40°

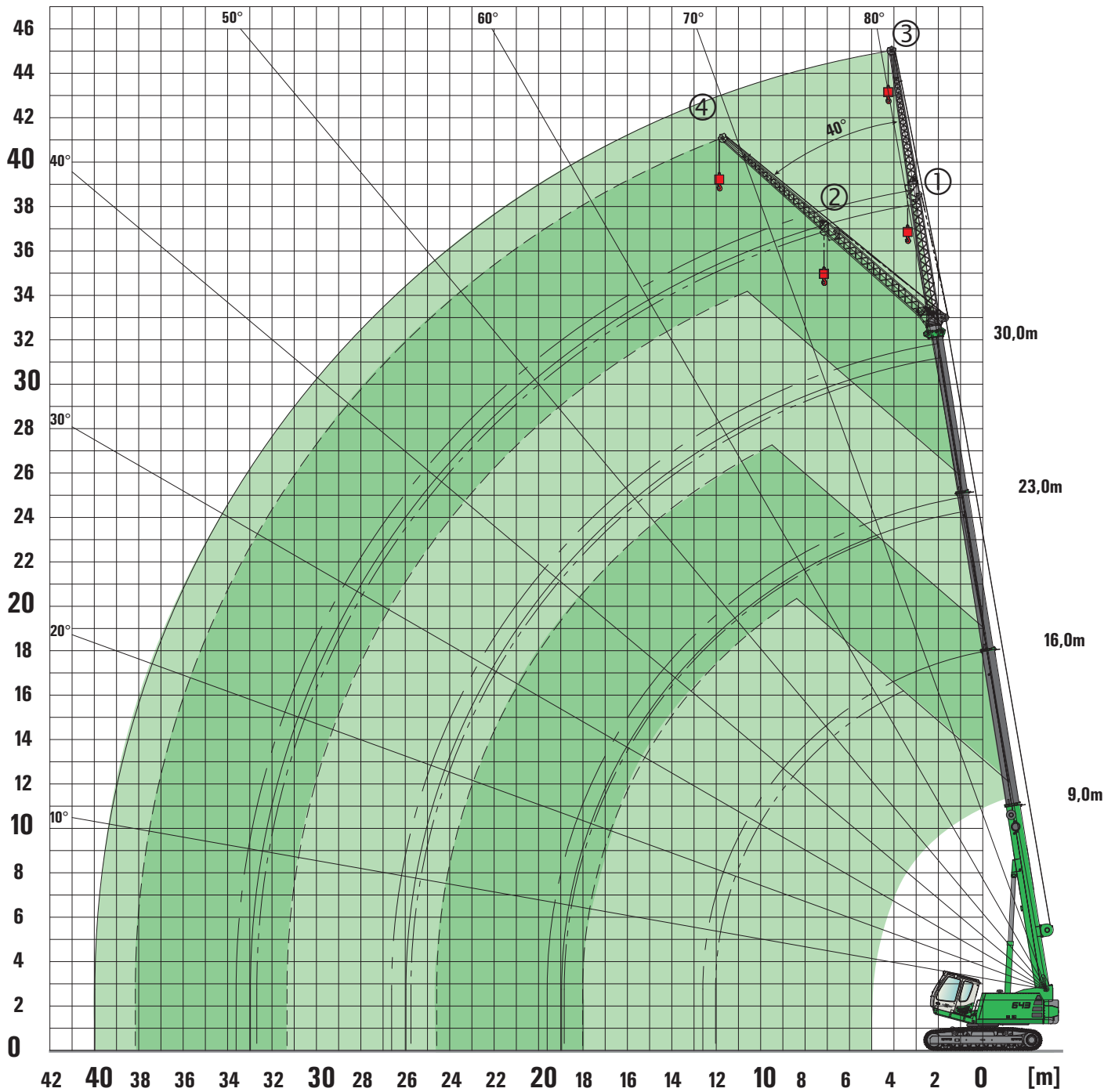

Notes:

1. The rated loads shown are based on the machine on firm level ground and without travelling
2. The rated loads shown are in metric tons valid for 360 degrees swing
3. Liftcrane capacities are calculated to comply with DIN 15019.2, ISO 4305 and 5° tipping angle
4. The rated loads shown include the weight of all lifting attachments, such as hook and bucket etc.
5. The rated loads "Spur 3800" are valid for the maximum extended undercarriage (track width 3800mm) The rated loads "Spur 2300" are valid for the retracted undercarriage
6. Users must derate or limit the lifted loads to allow for adverse conditions such as soft or uneven ground, out-of-level conditions, wind, side loads, pendulum action, jerking or sudden stopping of loads, inexperience of personnel and travelling with a load
7. Max. single line pull for crane operation with rope diameter 14 mm - 3.500 kg
8. Loads marked with * are only valid with special equipment.
9. Lifting capacities are for reference only. For actual lifting capacities please refer to load chart in operator's manual.

Spitzenausleger / Folding jib







5,4t/7t+4t

30 m

6,5 m

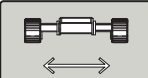
Ausladung / radius	Auslegerlänge / boom length [m]							
	9,0		16,0		23,0		30,0	
	0°	40°	0°	40°	0°	40°	0°	40°
2,0								
3,0	6,0		6,0					
4,0	6,0		6,0					
5,0	5,5	3,5	6,0		6,0			
6,0	4,9	3,3	6,0	3,6	6,0			
7,0	4,4	3,1	5,9	3,4	6,0		3,5	
8,0	4,0	2,9	5,4	3,3	5,9	3,4	3,5	
9,0	3,7	2,8	5,0	3,2	5,6	3,3	3,5	
10,0	3,4	2,7	4,6	3,1	5,3	3,2	3,5	3,2
11,0	3,1		4,3	3,0	5,0	3,2	3,5	3,0
12,0	2,8		4,1	2,8	4,7	3,1	3,5	2,9
13,0			3,9	2,8	4,2 / 4,4	3,0	3,5	2,8
14,0			3,7 / 3,3	2,8	3,7 / 4,2	2,9	3,3	2,7
15,0			3,4 / 3,5		3,3 / 3,9	2,9	3,0	2,5
16,0			3,0 / 3,3		3,0 / 3,7	2,8	2,8	2,4
18,0			2,3 / 2,9		2,4 / 3,3	2,7	2,3 / 2,4	2,3
20,0					1,9 / 2,7	2,1 / 2,6	1,8 / 2,1	2,1
22,0					1,5 / 2,2		1,5 / 1,9	1,7 / 1,9
24,0					1,1 / 1,7		1,1 / 1,8	1,4 / 1,7
26,0					0,8 / 1,4		0,9 / 1,5	1,0 / 1,6
28,0							0,7 / 1,2	
30,0							- / 0,9	
32,0							- / 0,7	
34,0								
36,0	Tab-Nr.: 643R-30.0/75/1977/5.4/08.06 SA6.5							
38,0	Tab-Nr.: 643R-30.0/75/1977/7.0/08.06 SA6.5							
Strangzahl / parts reeving	2	1	2	2	2	1	1	1
I	0%		100%		100%		100%	
II	0%		0%		50%		100%	
III	0%		0%		50%		100%	





5,4t/7t+4t

30 m

13 m

Ausladung / radius	Auslegerlänge / boom length [m]							
	9,0		16,0		23,0		30,0	
	0°	40°	0°	40°	0°	40°	0°	40°
2,0								
3,0	3,0							
4,0	3,0							
5,0	3,0		3,0					
6,0	3,0		3,0					
7,0	2,9		3,0		3,0			
8,0	2,6		3,0		3,0			
9,0	2,3		2,9		3,0		2,0	
10,0	2,1	1,6	2,7		2,9		2,0	
11,0	2,0	1,5	2,5		2,7		2,0	
12,0	1,8	1,4	2,4	1,5	2,6		2,0	
13,0	1,7	1,4	2,2	1,5	2,5		2,0	
14,0	1,6	1,3	2,1	1,5	2,4	1,5	2,0	
15,0	1,6	1,3	2,0	1,4	2,3	1,5	2,0	
16,0	1,5	1,3	1,9	1,4	2,2	1,4	2,0	1,5
18,0	1,1		1,7	1,3	2,0	1,4	2,0	1,4
20,0			1,6	1,3	1,8	1,3	1,9	1,4
22,0			1,4		1,7	1,3	1,7	1,3
24,0			1,3		1,6	1,3	1,4 / 1,6	1,3
26,0					1,3 / 1,4	1,3	1,2 / 1,4	1,2
28,0					1,0 / 1,3		1,0 / 1,3	1,2
30,0					0,8 / 1,3		0,8 / 1,2	1,1
32,0					0,6 / 1,1		0,6 / 1,1	0,8 / 1,1
34,0							- / 0,9	
36,0	Tab-Nr.: 643R-30.0/75/1977/5.4/08.06 SA13.0							
38,0	Tab-Nr.: 643R-30.0/75/1977/7.0/08.06 SA13.0							
Strangzahl / parts reeving	1	1	1	1	1	1	1	1
I	0%		100%		100%		100%	
II	0%		0%		50%		100%	
III	0%		0%		50%		100%	

Neue Großraum-Komfortkabine mit Schiebetür

New king-sized comfort cabin with sliding door

MAX CAB

Luftgefederter Komfortsitz
mehrfach verstellbar mit Bandscheibenstütze und Sitzheizung, einstellbare Armlehnen

Air suspended comfort seat
adjustable with lumbar support and seat heating, adjustable armrests



Schiebetür

erleichtert sicheres und bequemes Ein- und Aussteigen

Sliding door

Simplified and safe access to the operator's cab



Beste Ergonomie

Sitz ergonomisch komplett individuell zu den Steuerhebeln und separat zu den Fußpedalen einstellbar

Best ergonomics

ergonomic operator's seat, individually adjustable in height and angle for optimum working environment and operator's comfort



SENNEBOGEN Diagnostic-System

zur Überwachung aller wichtigen Maschinen- und Motorfunktionen

SENNEBOGEN Diagnostic system

for monitoring of all essential machine and engine functions

Hydraulisch um 15° neigbare Kabine

mit getöntem Sicherheitsglas, hydraulisch gedämpft und schwingungsgedämpft gelagert

Hydraulically tiltable cab ; 15°

with safety glass tinted, hydraulically damped, resiliently mounted

Trittrost mit Geländer

serienmäßig = Sicherheit beim Auf- und Abstieg

Step with railing

Standard - safety in entering and exiting



Heiz-Klimaautomatik

mit Temperatursteuerung, 8 einstellbare Lüfterdüsen sorgen für wohlige Klima, starke Defrosterfunktion, Frischluft/ Umluftsteuerung mit Partikelfilter

Automatic regulation

of heating and air condition according to temperature setting, 8 adjustable air vents provide excellent defrosting, air/circulation function, particle filter for outside and circulation air

Maße / Dimensions



9-30 m

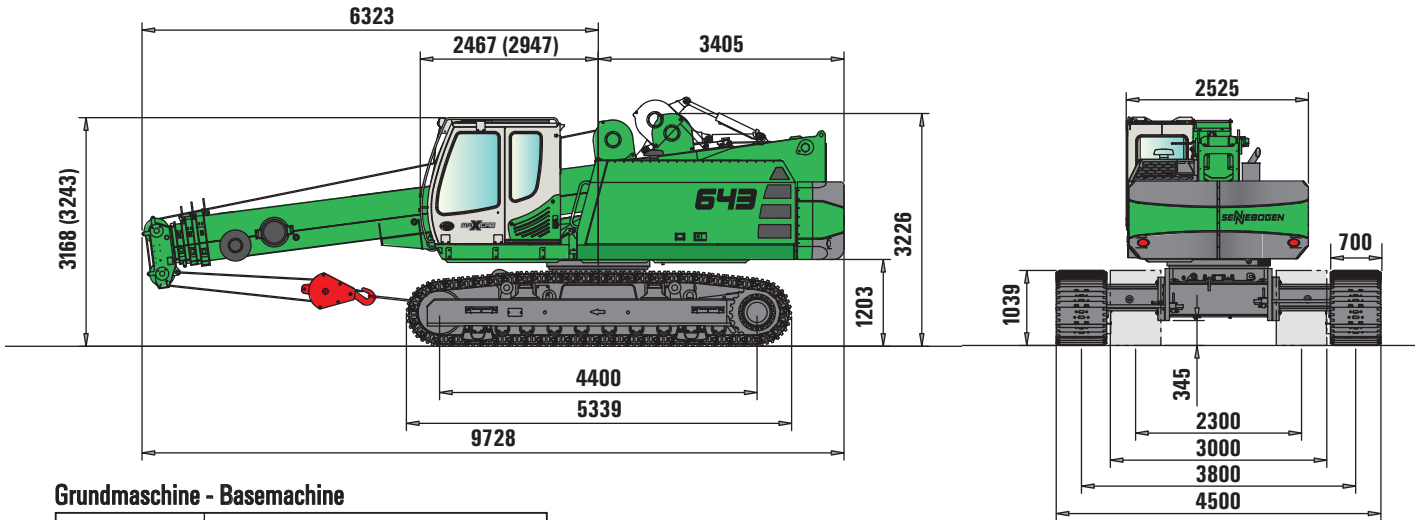

Grundmaschine - Basemachine

Bodenplatten Shoe width	Min. Transportbreite Min. Transport width
700 mm	3000 mm
800 mm	3300 mm
900 mm	3400 mm

Die Werte in Klammern gelten für hochfahrbare Kabine D200V.
Dimensions in brackets are valid for height-adjustable cab D200V.



Kapazität Capacity	Gewicht Weight	Seileinscherung und max. Traglast - No. of hoist reeving and max. rated load									
		9	8	7	6	5	4	3	2	1	
32 t 4-Rollen	300 kg	31.500 kg	28.000 kg	24.500 kg	21.000 kg	17.500 kg	14.000 kg	10.500 kg	7.000 kg	3.500 kg	
20 t 3-Rollen	220 kg			24.500 kg	21.000 kg	17.500 kg	14.000 kg	10.500 kg	7.000 kg	3.500 kg	
4 t	40 kg									3.500 kg	



6 t

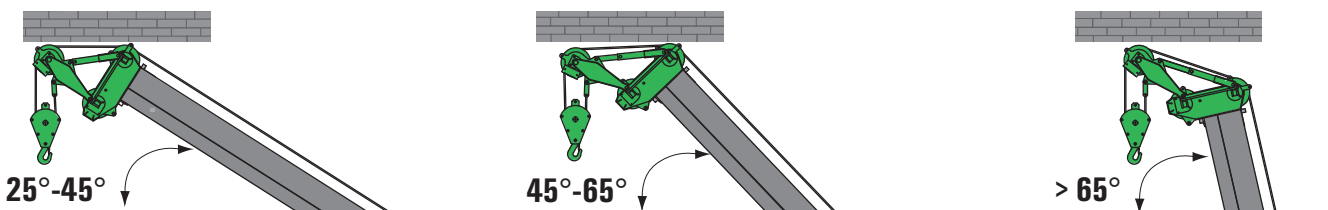

Notizen / Notes

A large grid of graph paper with green lines, intended for taking notes. The grid is approximately 30 columns wide and 40 rows high.

Notizen / Notes

A large grid of graph paper for taking notes, consisting of 20 columns and 30 rows of small squares.

643_R

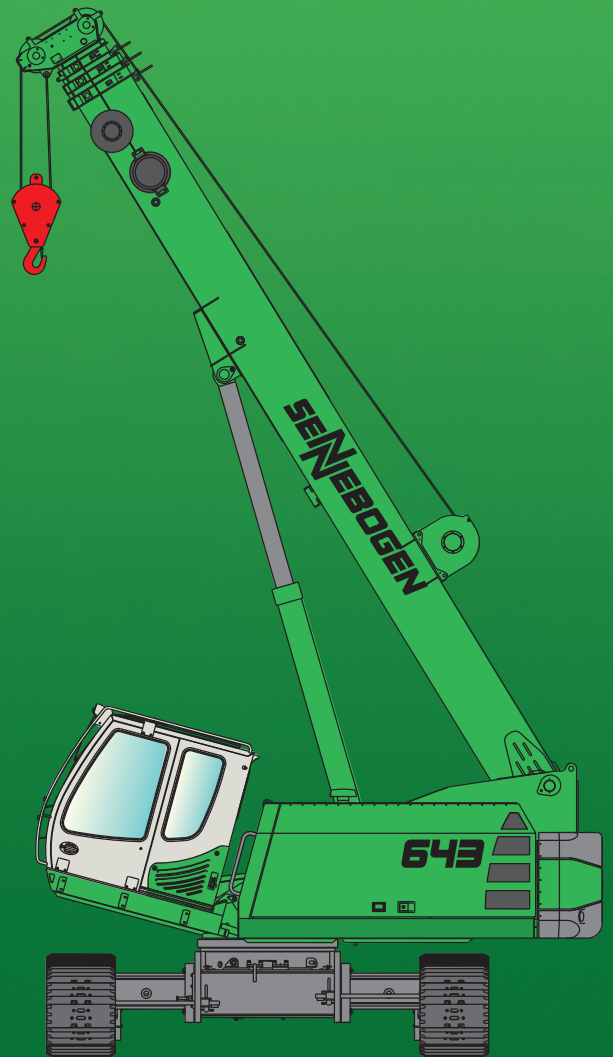

Dieser Katalog beschreibt Maschinenmodelle, Ausstattungsumfänge einzelner Modelle und Konfigurationsmöglichkeiten (Serienausstattung und Sonderausstattung) der von der SENNEBOGEN Maschinenfabrik gelieferten Maschinen. Geräteabbildungen können Sonder- und Zusatzausstattungen enthalten. Je nach Land, in das die Maschinen geliefert werden, können Abweichungen von der Ausstattung möglich sein, insbesondere bzgl. der Serien- und Sonderausstattung. Alle verwendeten Erzeugnisbezeichnungen können Marken der SENNEBOGEN Maschinenfabrik GmbH oder anderer, zuliefernder Unternehmen sein, deren Benutzung durch Dritte für deren Zwecke die Rechte der Inhaber verletzen kann.

Bitte informieren Sie sich bei Ihrem SENNEBOGEN Vertriebspartner vor Ort über die angebotenen Ausstattungsvarianten. Gewünschte Leistungsmerkmale sind nur dann verbindlich, wenn sie bei Vertragsschluss ausdrücklich vereinbart werden. Liefermöglichkeiten und technische Änderungen vorbehalten. Alle Angaben sind ohne Gewähr. Ausstattungsänderungen und Weiterentwicklungen vorbehalten.

© SENNEBOGEN Maschinenfabrik GmbH, Straubing/Deutschland. Nachdruck, auch auszugsweise, nur mit schriftlicher Genehmigung der SENNEBOGEN Maschinenfabrik GmbH, Straubing/Deutschland.

This catalog describes machine models, the scope of equipment of individual models and configuration possibilities (standard equipment and special equipment) of the machines delivered by SENNEBOGEN Maschinenfabrik. Device illustrations can contain special equipment and supplemental equipment. Depending on the country where the machines are delivered, deviations from the equipment can be possible, particularly relative to the standard equipment and special equipment.

All product designations used can be trademarks of SENNEBOGEN Maschinenfabrik GmbH, or trademarks of other companies who are suppliers to SENNEBOGEN Maschinenfabrik GmbH, the use of which by third parties can violate the rights of the trademark owner.

Information concerning the equipment variants offered is provided on site by your SENNEBOGEN Sales Partner. Desired performance characteristics are only binding, if they have been expressly agreed when the contract is concluded. Availability and technical specifications are subject to change without notice. All information is provided without guarantee of correctness or completeness. Equipment changes and further developments are subject to change without notice.

© SENNEBOGEN Maschinenfabrik GmbH, Straubing/Deutschland. Reproduction, even in part, only with written permission of SENNEBOGEN Maschinenfabrik GmbH, Straubing/Germany.

SENNEBOGEN

SENNEBOGEN
Maschinenfabrik GmbH
Sennebogenstraße 10
94315 Straubing, Germany

Tel. +49 9421 540-144/146
Fax +49 9421 43 882
marketing@sennebogen.de

GO FOR GREEN

 www.sennebogen.de
Courtesy of Crane.Market

BestellNr. / Item No. 108146
643R-040720-070710-020810* -030830-060930* -031025-031120* -011215- 101310-031410*