

NATIONAL SERIES 4

Truck-mounted telescoping cranes and accessories

Maximum height: 94 feet/28.6 meters

Maximum capacity: 16,000 pounds/7.3 metric tons

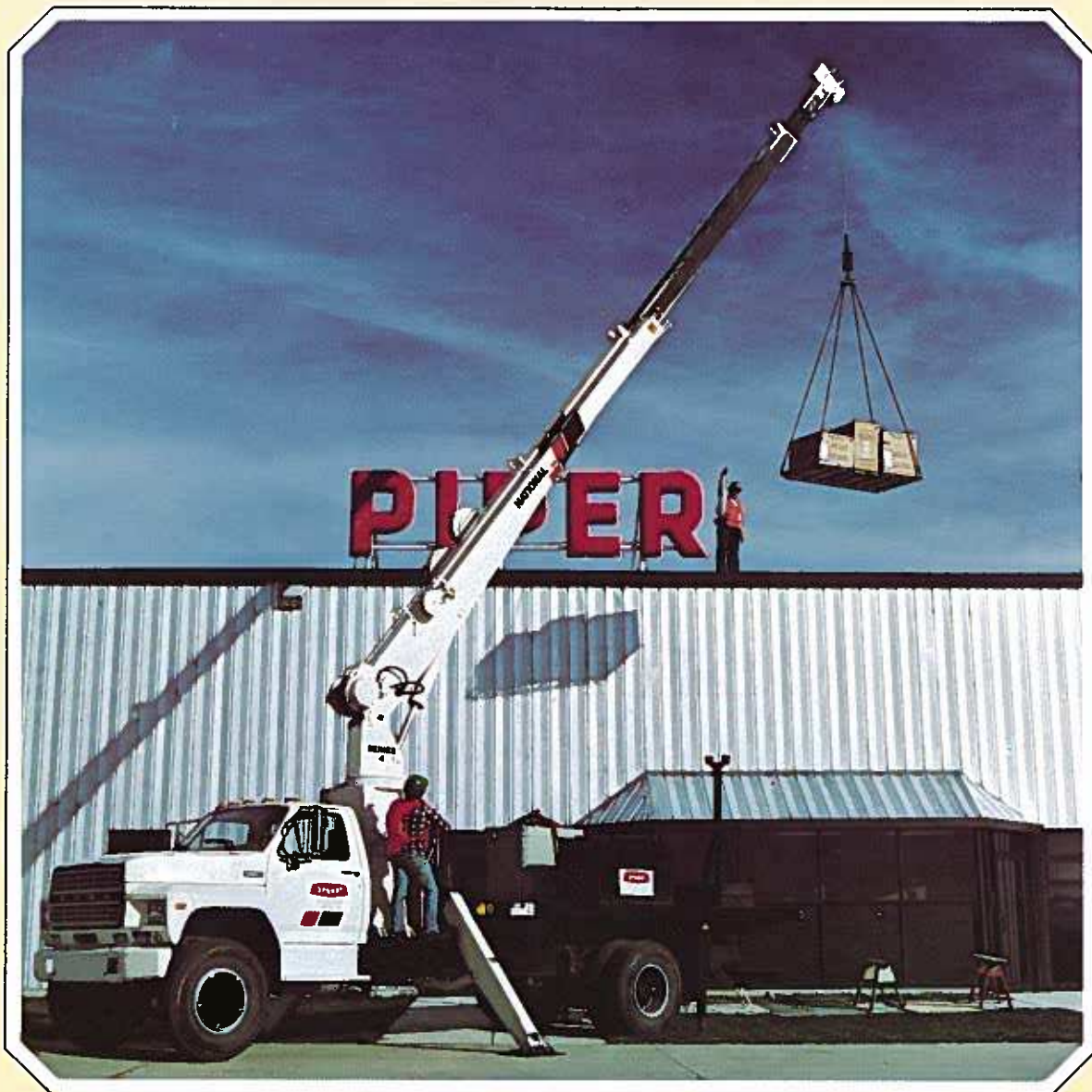
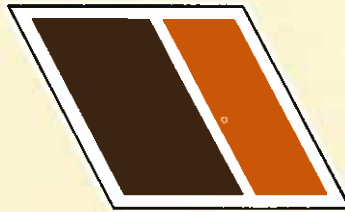

NATIONAL SERIES 4

National is America's largest maker of truck-mounted telescoping and articulating cranes. We build cranes for virtually every job.

Our Series 4 gives you everything you're looking for in a tough, compact crane. Strong construction. Wide, stable stance. Low truck requirements. Extra reach. Greater capacity. And extra control. All the things you expect from a leader.

Stronger, Lighter Booms

Extra strength and lighter weight mean greater capacity for you, so our telescoping boom sections are fabricated from four high strength steel members welded with perpendicular corners. This box-section construction lets us use thicker top and bottom plates for extra strength. And thinner side plates for increased capacity through lower boom weight. Only strong, low alloy steel is used, welded with advanced, automatic low hydrogen techniques for extra strong seams. All corner seams are ultrasonically tested for proper penetration.



Sequential Extension

We introduced sequential, full-load extension to the industry. Our boom sections interlock for sequential extension with larger, stronger boom sections extending first for greater strength. National's patented locks are mechanical, not hydraulic. They provide reliability with no wasted hydraulic power. Just one example of our engineering excellence paying off in performance for you.

Dual Controls

The Series 4 has standard dual controls for safe operation and to provide greater load visibility.

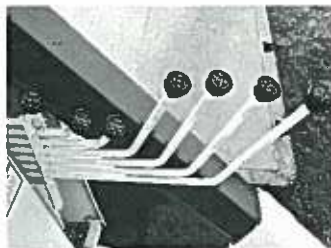
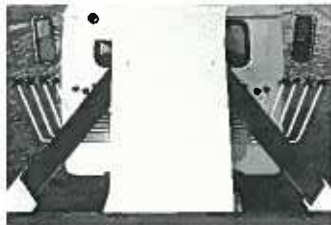

Positive Turret Rotation

Our Series 4 turret drive is built with extra heavy bearings both above and below the drive pinion. This ensures constant tooth alignment for smooth rotation and low wear. Even under maximum loads. The entire turret glides smoothly on a low inertia ball bearing race. Rotation is 375° noncontinuous.

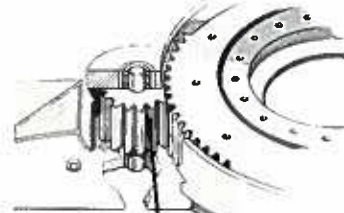

Less Space

The National Series 4 is built tough, but compact, so it fits in just 30 inches of bed space. In fact, you can add our optional crosswalk and take up no more room than comparable cranes. That leaves more payload space and makes your Series 4 even more versatile.



Wide Stance

We've given our Series 4 the famous National out-and-down outriggers for a consistently wide stance and better leveling on uneven ground. The

outriggers retract smoothly, without binding under load, first moving up, then in. Their efficient design gives you greater stability with less weight, so you can carry larger payloads.

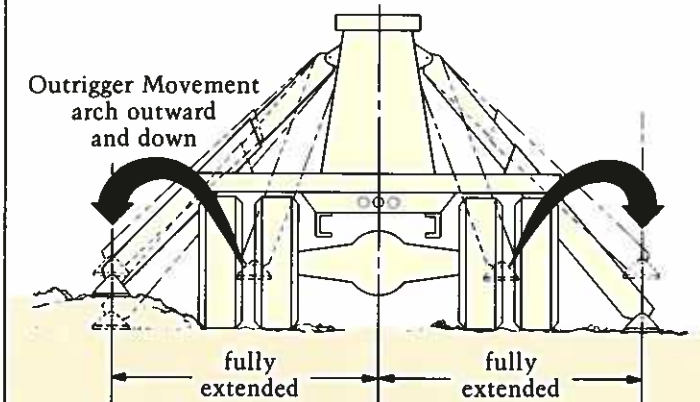

National's "Out-and-Down" Stable Outriggers

- Outriggers equally spaced from crane center line
- Consistent outrigger span
- Crane will be equally stable on both sides

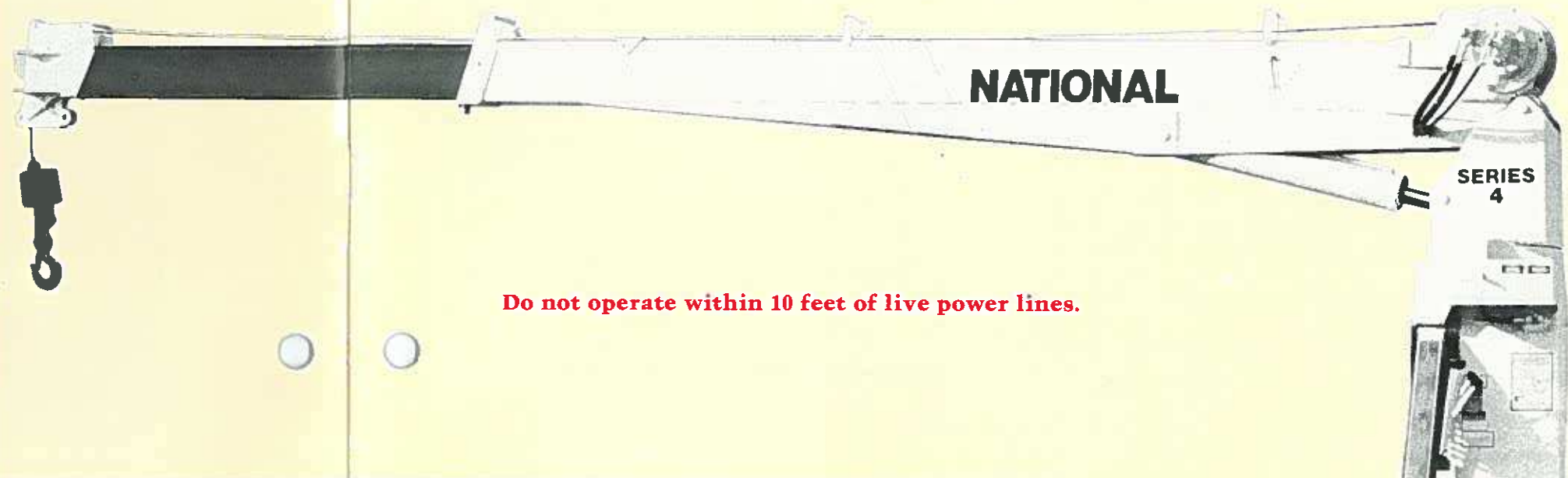

Do not operate within 10 feet of live power lines.

NATIONAL SERIES 4 BOOMS AND JIBS

The National Series 4 is available with a wide variety of booms and jibs. The charts on this page show the reaches and capacities of our two most popular boom/jib combinations. Your National dealer can provide information on our other combinations.

Boom and Jib Combinations

- The following boom and jib combinations are available.

Telescoping Booms

- Model 4T25: 12- to 25-foot three section Manual Pull-out 9- to 15-foot
- Model 4T27: 16- to 27-foot two section Straight 15-foot
- Model 4T33: 19- to 33-foot two section
- Model 4T46: 19- to 46-foot three section } Manual Pull-out 17- to 29-foot, Straight 18-foot, or Angling 18-foot
- Model 4T55: 22- to 55-foot three section

Jib Options (side stowing)

Do not operate cranes or accessories within 10 feet of live power lines.

- Load ratings shown on these charts are maximum allowable loads with the outriggers properly extended on a firm level surface and the crane leveled and mounted on a factory-recommended truck.
- Always level the crane with the level indicator located on the crane frame.
- The operator must reduce loads to allow for factors such as wind, ground

- conditions, operating speeds and the effect of freely suspended loads.
- Overloading this crane may cause structural collapse or instability.
- Weights of any accessories attached to the boom or loadline must be deducted from the load chart capacities.
- Do not exceed jib capacities at any reduced boom lengths.

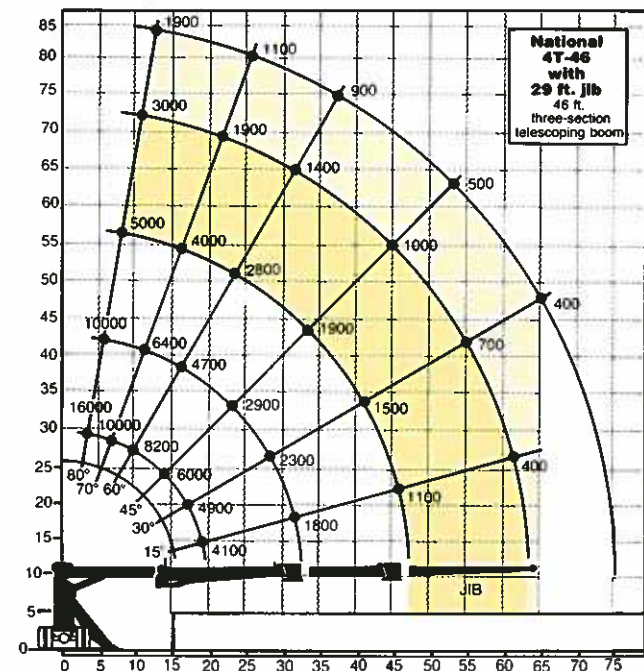
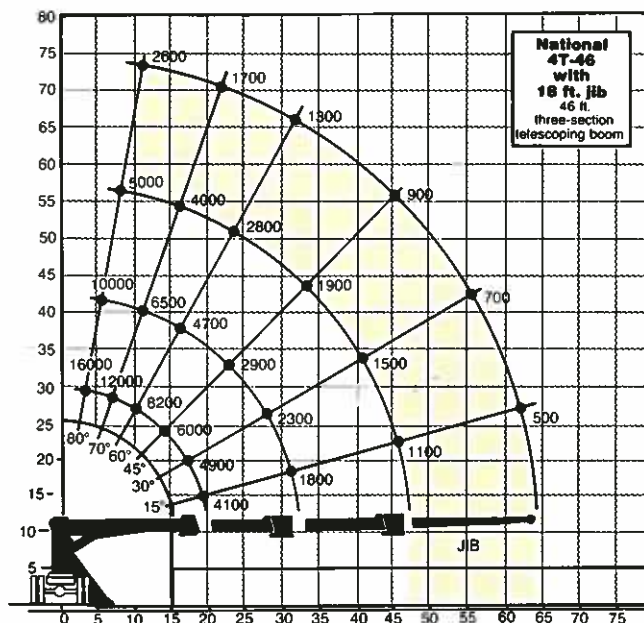

National Series 4 Winch Data

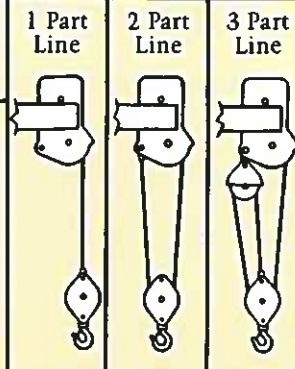

- Caution:**
- Do not deadhead lineblock against boom tip when extending boom
 - Keep at least three wraps of load line on drum at all times
 - Use only the specified cable on this machine

These are the ratings of the winch system when reeved accordingly.

Winch	Motor Selection	Cable Supplied	Average Breaking Strength	Lift and Speed	Lift and Speed	Lift and Speed
Tulsa Model 6	B	7/16 diam. 8x19 IWRC	17,940 lbs.	3,000 lbs. 110 fpm	5,800 lbs. 55 fpm	8,600 lbs. 35 fpm
Tulsa Model 6	C (standard)	7/16 diam. 8x19 IWRC	17,940 lbs.	4,500 lbs. 80 fpm	8,900 lbs. 40 fpm	13,000 lbs. 27 fpm
Tulsa TP-1	25 M 42	1/2 diam 8x19 IWRC	23,200 lbs.	6,440 lbs. 110 fpm	12,340 lbs. 55 fpm	18,200 lbs. 35 fpm

Maximum bare drum pulls are 4,100 pounds with Tulsa B motor, 5,800 pounds with Tulsa C motor, and 8,470 pounds with Tulsa 25 M 42 motor, but, because of the 3.5 to 1 OSHA safety factor, maximum rated pull on a single line cannot exceed 5,100 pounds on Tulsa Model 6 or 6,600 pounds on Tulsa Model TP-1.

NATIONAL SERIES 4 TRUCK SPECIFICATIONS

Minimum Truck Requirements

- GAWR**
Front 9,000 pounds
Rear 17,500 pounds*

GAWR means Gross Axle Weight Rating and is dependent on all components of the vehicle, such as axles, tires, springs, frame, etc., meeting manufacturer's recommendations. Always specify GAWR when purchasing trucks.

- GVWR** .. 26,500 pounds*
GVWR means Gross Vehicle Weight Rating

- Cab to Axle**
(CA) 120 inches on 4T25, 4T27; 138 inches on 4T33, 4T46, 4T55

- Wheelbase**
(WB) 184 inches on 4T25, 4T27; 202 inches on 4T33, 4T46, 4T55

- Frame Requirements**
Care must be taken in truck selection. Front and/or rear stabilizers require a minimum of 15 inch³ section modulus or the frame must be capable of being reinforced to 15 inch³. (Normally a tapered front frame cannot be reinforced to the required strength.) A factory furnished sub-base provides the 25 inch³ (50,000 PSI/MATERIAL MINIMUM) section modulus frame strength required for standard crane mounting.

NOTE: Minimum axle requirement may increase with use of diesel engines, longer wheel base, or service bodies. Contact factory for further information.

*Tandem axle trucks must be used for rear mounts or for hauling larger payloads.

Mounting Configurations

The versatility of the Series 4 can be enhanced by its mounting. Following is a brief description of the mounting configurations and the advantages of each:

Configuration 1:

This is the least expensive mounting method. In many cases, if the truck is purchased above minimum specifications such as with a diesel engine or a tandem axle, counterweight is not required. This mount requires the least weight for stability; thus, you can haul larger payloads on your truck.

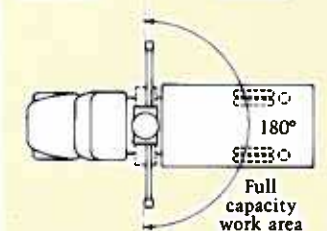
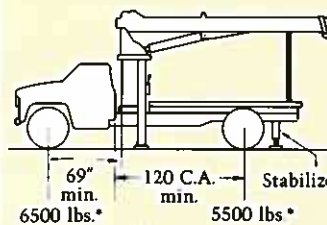

Requires 9,000-pound Gross Axle Weight Rating Front, 17,500-pound Gross Axle Weight Rating Rear, 26,500-pound Gross Vehicle Weight Rating, front and rear stabilizers and bed with counterweight. Full capacity work area is rear 180° of vehicle from outrigger to outrigger. Tandem axle trucks may be used for hauling larger payloads.

Configuration 2:

This mount requires front stabilizers and additional counterweight in the underside of the bed for full capacity 360° around the truck. The front stabilizers give the machine a solid base, helping the operator control his loads precisely.

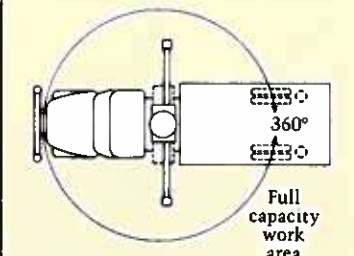
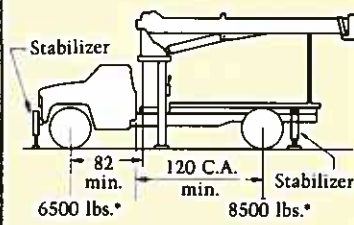

Requires 9,000-pound Gross Axle Weight Rating Front, 18,500-pound Gross Axle Weight Rating Rear, 26,500-pound Gross Vehicle Weight Rating, front and rear stabilizers, and usually requires a reinforced bed with counterweight. Tandem axle trucks may be used for hauling larger payloads.

Rear Mounting

Rear mounting must include reinforced bed and tandem axle. For further details contact our factory.

Configuration 3:

This mount allows 360° stability at full capacity without the use of front stabilizers. It requires additional weight at the rear of the truck to reduce loading on the front axle when lifting over the front. Since the front tires are used as a stabilizing base, this is recommended only for the operator who occasionally lifts loads over the front of the vehicle. If loads are to be continually lifted around the front of the vehicle, front stabilizers are recommended to give this mount a firm base.

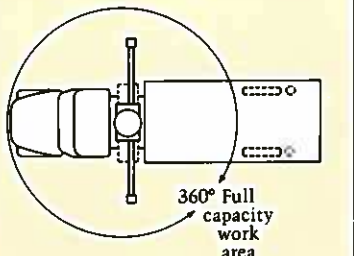
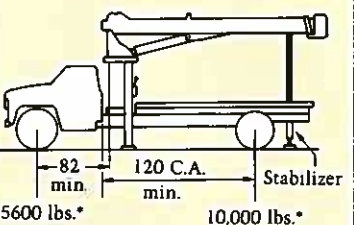

Requires 9,000-pound Gross Axle Weight Rating Front, 18,500-pound Gross Axle Weight Rating Rear, 26,500-pound Gross Vehicle Weight Rating, rear stabilizers and reinforced bed with counterweight in the underside. Full Capacity work area is 360° around the truck.

*Actual axle scale weights prior to installation of crane, bed and stabilizers.

NATIONAL SERIES 4 ACCESSORIES

Every Series 4 is more than a crane. It's part of the most complete lifting system available in the truck-mounted industry.

The National Lifting System lets your Series 4 do more than just lift or handle materials. It lets you turn one truck-mounted crane into a whole fleet of specialized vehicles. At a fraction of the cost.

Because it can do so many jobs from start to finish, you save time, money and manpower on almost every job you do. You'll find you can do more jobs, faster, with less equipment. And that's money in your pocket.

Every Series 4 crane is built to work with our accessory line. And every accessory we make is designed to work specifically with Series 4 cranes. That means attachment is quick and easy. Once the proper controls are installed, you're ready to work.

National's accessories are designed and manufactured to the same excellent standard as our cranes. This provides you with years of low maintenance, high-productivity service.

Get the most from your National Series 4... make it more than just a crane with low-cost, hardworking accessories from the National Lifting System.

Note:

Weights of all accessories attached to the boom or loadline of the crane must be deducted from the effective lifting capacity.

Consult your dealer for specific accessory availability. Some accessories cannot be used in combination with other accessories and/or certain boom/jib combinations.

Remote Control

The latest edition of our one-hand remote control. Ideal for use where precise control and total load visibility are required.

Fine metering and instant response mean operators can position loads, baskets and personnel platforms easily.

Now more reliable than ever with solid state circuitry and fewer parts than previous systems. Other improvements include higher operating speeds and modular design.

Available in two models: R4 with tilt, turn telescope and winch functions, and R3 with tilt, turn and telescope only. R3 should be used to control cranes from basket or platform, using optional extension cables.

A priority control valve, operated by a trigger on the remote control unit, regulates oil flow and gives you fingertip speed control over all crane functions.

National remote control is the lightweight, easy-to-use way to add extra versatility to your crane.

Model R3

Tilt, turn and telescope.

Model R4

Tilt, turn, telescope and winch.



Do not operate cranes or accessories within 10 feet of live power lines.

One Person Basket

Strong, lightweight fiberglass basket with 300 lbs. capacity puts personnel where you want them for tough maintenance and installation jobs. Optional dual basket bracket for 2 basket operation. Easy on-off. Safety belts included.

Model B1

Model B1-L
With lock.

Do not operate cranes or accessories within 10 feet of live power lines.

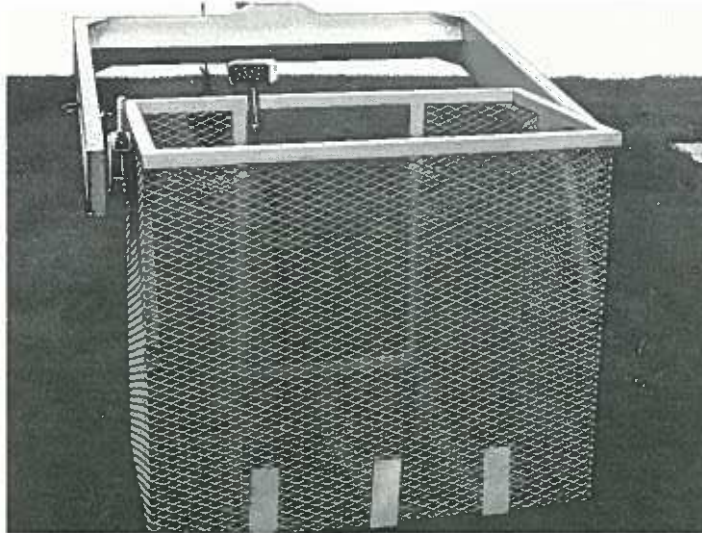
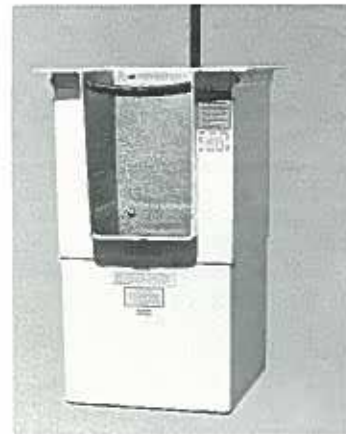

Two Person Basket

Extra capacity (500 lbs.) steel basket for even greater crane versatility. Swing mounted to self-level. Lever operated friction brake for stability and locking. Safety belts included.

Model BS-1

5 ft. yoke.

Model BS-2

12 ft. yoke. Side Stow.

Do not operate cranes or accessories within 10 feet of live power lines.

Personnel Platform

This extra strength 3 x 6 ft. steel platform will carry up to 1,000 lbs. and operate at working heights up to 70 ft. It is hydraulically self-leveling and protected by safety valves. Safety belts included. Fold down sides standard.

Optional manual rotator available for precise placement of the platform. Easy-to-operate crank rotates the platform through a dependable chain drive. Continuous rotation. Locks in position.

Model SLP

Model SLPR

Do not operate cranes or accessories within 10 feet of live power lines.



Crosswalk

For extra convenience. Allows operator to walk between cab and crane for extra visibility when working loads on both sides. All steel construction with expanded steel mesh floor for firm footing.

Model CW



Outriggers and Stabilizers

We offer a complete range of cross-frame outriggers and front and rear stabilizers with hydraulic vertical and horizontal motion.

Outriggers

Extended Span 13' 6"
Retracted Span 7' 11"

Vertical Travel
Over-Frame 25"
Under-Frame 18"

Ground Penetration
(38" Frame Height) .10"

Mounting Space
Crane/Outrigger .. 52"
Outrigger Only ... 18"

Mounting
Behind cab, at rear of chassis or both.

Stabilizers

	Rear Mounted (Models RSH-15/18/25)	Front Mounted (Model FSH-25 Fixed, Model FSHF-25 Folding)
Vertical Travel	15", 18" or 25"	25"
Ground Penetration (38" Frame Height)	3", 6" or 13"	13"
Operation	All-Hydraulic	All-Hydraulic
Span	6' (RSH-15) 8' (RSH-18/25)	8'
Controls	Operated from either crane control station	

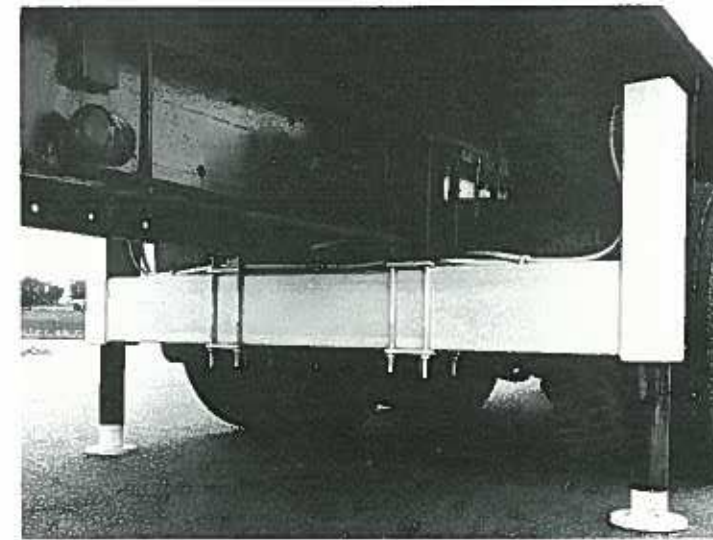

Planetary Winch

Optional extra capacity, heavy-duty winch with planetary gear drive for smoothness and strength.

Model TP-1

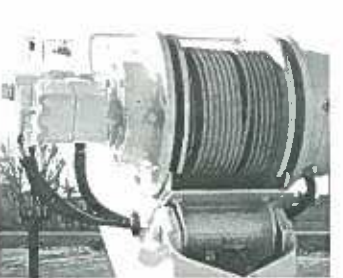

NATIONAL BOOM RESTS

NATIONAL SERIES 4 SPECIFICATIONS

Cranes are tough when they're in use, but they can be severely damaged during travel from job to job.

The only way to make sure your crane is protected from inadvertent damage is a strong, solid boom rest.

Boom Rests:

Add years to the life of your crane • Reduce stress on the crane frame • Protect rotation gear from transit damage • Remove stress from truck frame • Spread crane load more evenly • Reduce maintenance and downtime.

In addition, boom rests offer you a safe, positive way to immobilize your crane for transit.

We offer five heavy-duty boom rests for strong, sure protection of your crane. There's a quality National boom rest to fit your mounting configuration.

So protect your investment and add additional low maintenance years to the life of your crane with a boom rest tailored to your truck/crane combination. All factory-mounted cranes will be supplied with boom rests.

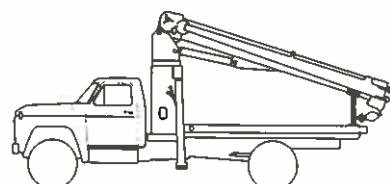

Low-profile rear bed mount for lower center of gravity

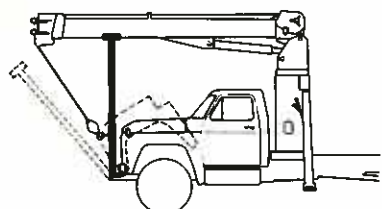

Front mount for trucks with tilting hoods

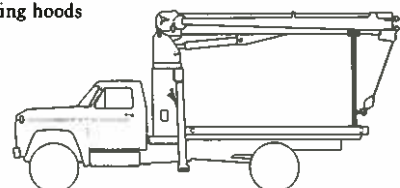

Horizontal rear bed mount for greater load space

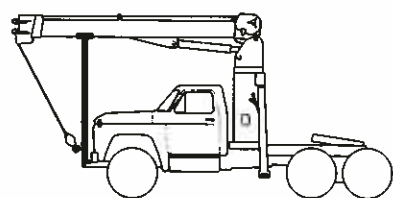

Tractor/trailer front mount

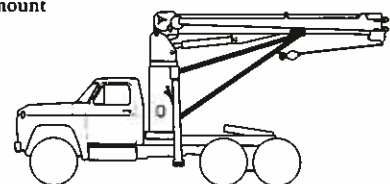

Tractor/trailer rear mount

General Construction:

Low-alloy, high-strength steel, including T-1, Ex-Ten, Stressproof, Hi-Yield, and other steels combined with special, low-hydrogen welding techniques wherever advantageous. Painted National Ivory.

Frame:

Box construction. Weld on truck frame reinforcement forms base for crane frame. Bolt-on optional.

Turret:

Fabricated, rigid structure, well-braced for strength and stability.

Rotation:

375° noncontinuous. Rotational force 120,000 in./lbs. (360,000 in./lbs. breaking strength). Turret rotation by hydraulic orbit motor with worm gear driving a pinion with outboard bearing. The turret rotates on a ball bearing race.

Outriggers:

"A" frame box type 13'6" span (center of pad at ground level) moves out-and-down, will not bind when raising or lowering truck. Can be positioned to 8" below ground level when mounted on truck with a frame height of 38". Outrigger cylinders are equipped with butt-mounted, safety check valves.

Tilt:

Double-acting hydraulic cylinder raises and lowers boom; butt-mounted, safety holding valve prevents boom from falling in event of hose failure.

Boom:

Boxed construction. Telescopes hydraulically in sequence under rated load on nylon plates impregnated with molybdenum disulfide which permits maximum loads to be extended at greater radii. Holding valves prevent retraction except under power.

Controls:

Dual side, stand-up, with operator platform and foot accelerator. Simultaneous operation of load-line and other operations standard.

Winch:

11,000 lbs. breaking strength. Hydraulic orbit motor provides "power down" load lowering. Choice of two capacities: 5,800 or 4,100 lb. pull on bare drum; only 25% less pull on final wrap with spool filled with 185 feet of 7/16 inch 8x19 IWRC, spin-resistant 8.97 ton breaking strength wire rope. Optional planetary winch available with 8,470 lb. bare drum single-line pull and 200 feet of 1/2" 11.6 ton breaking strength loadline.

Pump:

One Vickers, high-pressure, high-speed, balanced-vane, replaceable cartridge-type providing 25 gpm, maximum.

Cylinders:

Shaft packing: Polyurethane cup type. Shafts Hi-Yield, stress-relieved, chrome-plated. Piston sets: Cup and rider construction using stiff-back flex-lip, graphite cups. Cylinder barrels: Micro-honed tubing. Butt-mounted, safety check valves.

Valves:

Four-way, spring centered, spool-type with independent relief valves set at 2,350 psi (maximum 2,250 psi on winch system) to protect circuits against overload.

Hose:

All high-pressure hose is wire-braid reinforced, having a minimum safety factor of 4 to 1.

Operating Speeds:

Load line: Choice of 80 or 110 fpm. Optional winch: 110 fpm. Boom up or down: 22 seconds. Boom out: 19' to 46' in 47 seconds. Boom in: 46' to 19' in 35 seconds. Turn: 375° in 42 seconds (average). When using remote control, crane function speeds will be reduced by 50% to assure smooth operation. (Speeds above assume no load and pump speed at 1,800 rpm.)

Oil Tank Capacities:

30 gallon supply tank. Normally mounted under right hand operator's control platform. System has an approximate 50 gallon total capacity.

Filter:

10-micron, replaceable-cartridge, return-line filter.

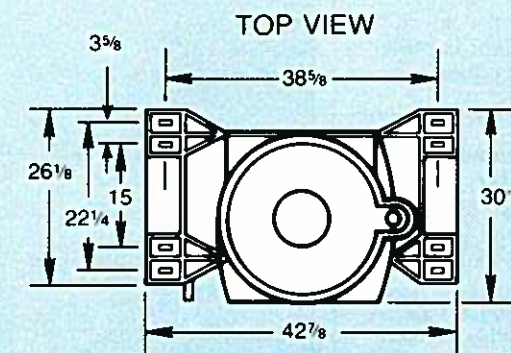

CENTER OF GRAVITY		
4 N 19	28	WT 5200
4 T 25	32	WT 6300
4 T 27	34	WT 6000
4 T 33	43	WT 6300
4 T 46	52	WT 7300
4 T 55	65	WT 7800

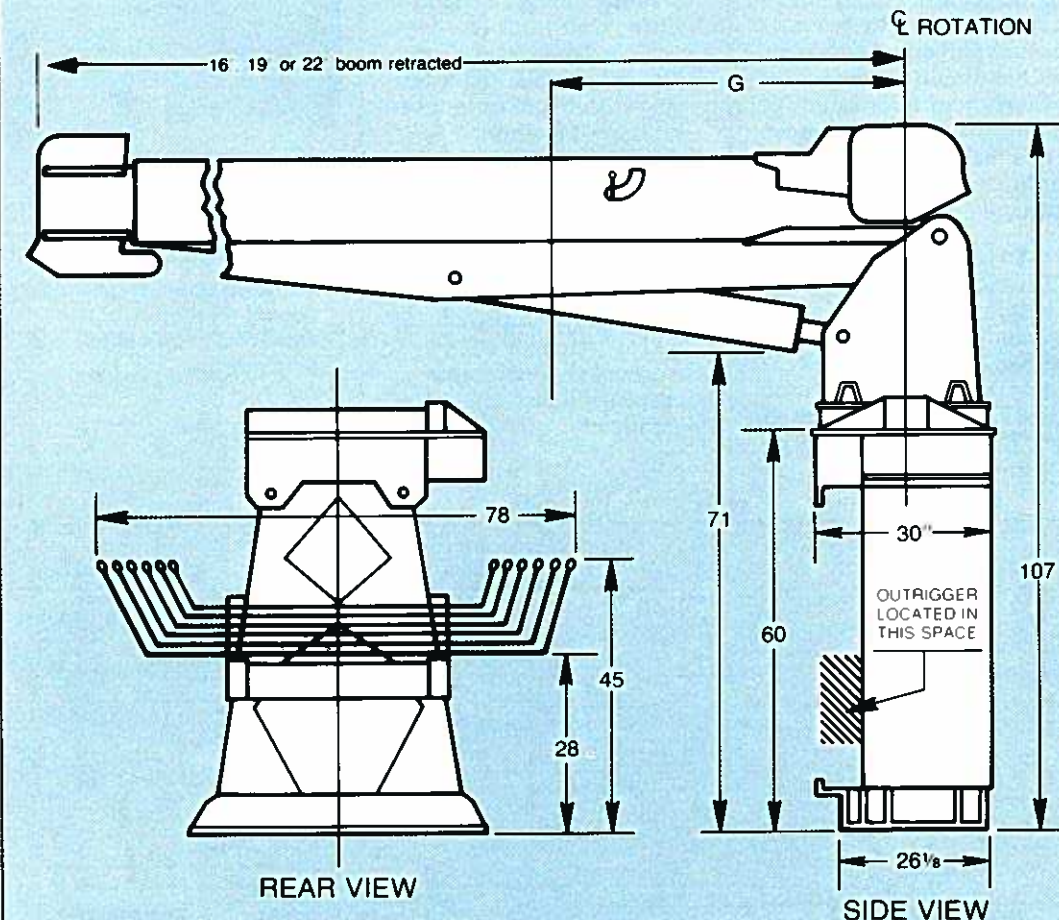

NATIONAL SERIES 4 FOLDING BOOM OPTION

Folding Boom

This unique option is ideal for use with tractor/semi-trailer combinations or other installations requiring maximum bed space. The boom folds and stows over the cab, so there's no interference with payload or trailer.

The Series 4FT option is compact and easy to use, yet it retains all the strength of the standard Series 4 boom. The 4FT is completely hydraulic to a 27 ft. radius and a sheave height of 52 ft. can be achieved using the optional 9 ft. jib with 6 ft. manual pull-out. The boom folds hydraulically and contains four telescoping sections. The jib folds and stows manually. Shares specifications with the standard Series 4.

Requirements

Truck Weight:

12,000 lb. minimum including platform-capacity loads to be lifted over outriggers and rear of truck—stabilizers required for full circle capacity lifting.

**Axles/GAWR:

Front 12,000 lbs. (if front axle weight is less than 7200 lbs.), 14,000 lbs. (if front axle weight is more than 7200 lbs.). Rear 18,000 lbs.

Front of Crane Frame to Rear Axle:

120 inches minimum, less may be required if stabilizers are utilized.

Front of Crane Frame to Front Axle:

69 inches minimum. Stabilizer must be used for lifting over front of vehicle. Some frames are tapered through the front suspension and cannot be reinforced for front stabilizers.

Frame:

Normal reinforcing is furnished by National Crane Corporation. When stabilizers are utilized, 15 inches³ strength is required through frame suspension to the stabilizer.



Frame Heights:

Contact factory if distance from top frame to ground is over 42 inches in the area where the crane is to be mounted.

****GAWR** means Gross Axle Weight Rating and is dependent on all components of the vehicle, such as axles, tires, springs, frame, etc., meeting manufacturers' recommendations. Always specify GAWR when purchasing trucks.

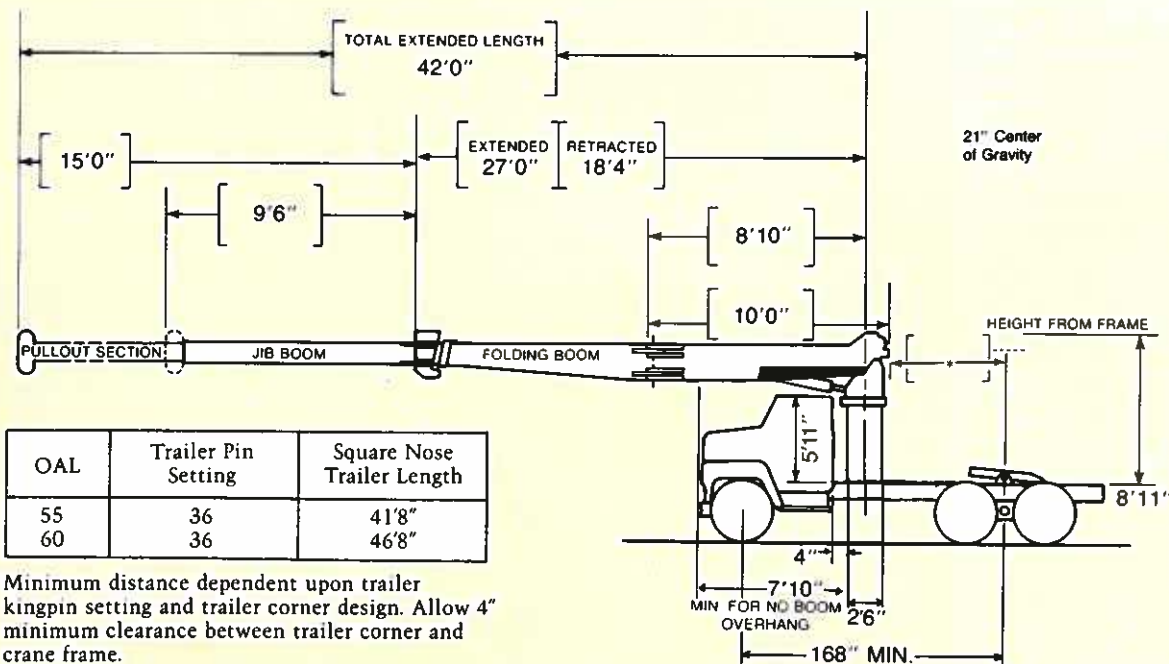

NATIONAL SERIES 4 PROPOSAL

DATE: _____

Prepared for: _____

Submitted by: _____

(Firm Name)

(Address)

(City & State)

(Zip)

(Phone)

Signed: _____

Description:

1. Series _____ \$ _____
2. Boom _____
3. Jib _____
4. Winch Standard _____ Motor TPI _____
5. Rear Stabilizers 18" 25" Stroke _____
6. Front Stabilizers Std. Tilt _____
7. Line Block 2 Part 2 & 3 Part _____

Attachments:

8. _____
9. _____
10. _____

Mounting:

11. Installment Std. Spec. _____
12. Frame re-enforcing Weld Bolt-Extra _____
13. Platform Body _____ Ft. Wood Steel _____
14. 1100 lbs. front bumper (if required) _____
15. Weight in bed _____ lbs. (if required) _____
16. Boom rest Parallel Low Other _____
17. Mount RSH _____
18. Mount FSH _____
19. Chassis _____
20. Rear Bumper _____
21. Freight _____

This quotation will remain firm for _____ days.

Accepted by: _____ \$ _____
(Name) TOTAL PRICE

(Firm Name) _____ Date

NATIONAL WARRANTY PARTS AND SERVICE

The National Warranty

No product is better than its warranty. And no warranty is better than the company behind it.

We didn't get to be America's largest manufacturer of truck-mounted telescoping and articulating cranes by building less than the best. Or backing them with less than the most comprehensive warranty possible.

Our warranty covers your crane against defects in materials or workmanship for 6 full months from the date of shipment, subject to the conditions of the warranty.

When you select a National crane, you're getting more than just a crane. You're getting a nationwide dealer warranty

service network, strong warranty protection and our special concern for every product we make.

Read our warranty. Then, don't settle for less. For complete information, write National Warranty Service, Waverly, NE 68462.

The National Parts System

Because even National cranes need parts, we back our dealers with an immediate, extensive parts supply. That way, your crane can get back on the job fast.

We have a highly trained parts and service staff to answer dealer service questions and expedite parts shipping. Most National parts can be on their way within 48 hours on request.



The National Service Center

Just west of Lincoln, Nebraska, we maintain one of the finest crane and truck service centers in the

United States. Here, we do all our factory crane mounting.

Here, too, we research new and better products and fabricate custom cranes and installations.

The central location of our Lincoln Service Center makes it easy to return cranes for special modifications or extreme repairs. Most National dealers can perform all but the most unusual modifications or most serious repairs.

Should you need to return your crane to us for modification, warranty repair or other service, we will give it priority care and see it's returned as soon as possible.

National reserves the right to change design, prices and specifications at any time without notice.

NATIONAL CRANE
Subsidiary of Kidde, Inc.
KIDDE

General Offices

11200 North 148th Street/Waverly, NE 68462/(402) 786-2240

Service Center

701 N.W. 27th Street/Lincoln, NE 68528/(402) 474-2666

Your National Dealer

**SERIES
4**