

# Load Rating Chart

**Model TC45131**



© Manitex 2000

---

**NOTE:** Additional copies of this Load Rating Chart can be purchased from your Manitex Distributor. When ordering, use the part number shown in the bottom left hand corner of this page.

## LMI OPERATING CODES

<b>CODE</b>	<b>CRANE CONFIGURATION</b>	<b>OUTRIGGER CONFIGURATION</b>	<b>AREA OF OPERATION</b>	<b>CWT (LBS)</b>	<b>PAGE</b>
1	MAIN BOOM	100% EXTENDED	FULL 360°	10000	11
2	MAIN BOOM	100% EXTENDED	FULL 360°	8750	12
3	MAIN BOOM	100% EXTENDED	FULL 360°	7500	13
4	MAIN BOOM	100% EXTENDED	FULL 360°	6250	14
5	MAIN BOOM	100% EXTENDED	FULL 360°	5000	15
6	MAIN BOOM	100% EXTENDED	FULL 360°	3750	16
7	MAIN BOOM	100% EXTENDED	FULL 360°	2500	17
8	MAIN BOOM	100% EXTENDED	FULL 360°	1250	18
9	MAIN BOOM	100% EXTENDED	FULL 360°	0	19
10	MAIN BOOM	100% EXTENDED	OVER REAR	10000	20
11	MAIN BOOM	100% EXTENDED	OVER REAR	8750	21
12	MAIN BOOM	100% EXTENDED	OVER REAR	7500	22
13	MAIN BOOM	100% EXTENDED	OVER REAR	6250	23
14	MAIN BOOM	100% EXTENDED	OVER REAR	5000	24
15	MAIN BOOM	100% EXTENDED	OVER REAR	3750	25
16	MAIN BOOM	100% EXTENDED	OVER REAR	2500	26
17	MAIN BOOM	100% EXTENDED	OVER REAR	1250	27
18	MAIN BOOM	100% EXTENDED	OVER REAR	0	28
19	MAIN BOOM	68% EXTENDED	FULL 360°	10000	29
20	MAIN BOOM	68% EXTENDED	FULL 360°	8750	30
21	MAIN BOOM	68% EXTENDED	FULL 360°	7500	31
22	MAIN BOOM	68% EXTENDED	FULL 360°	6250	32
23	MAIN BOOM	68% EXTENDED	FULL 360°	5000	33
24	MAIN BOOM	68% EXTENDED	FULL 360°	3750	34
25	MAIN BOOM	68% EXTENDED	FULL 360°	2500	35
26	MAIN BOOM	68% EXTENDED	FULL 360°	1250	36
27	MAIN BOOM	68% EXTENDED	FULL 360°	0	37
28	MAIN BOOM	68% EXTENDED	OVER REAR	10000	38
29	MAIN BOOM	68% EXTENDED	OVER REAR	8750	39
30	MAIN BOOM	68% EXTENDED	OVER REAR	7500	40
31	MAIN BOOM	68% EXTENDED	OVER REAR	6250	41
32	MAIN BOOM	68% EXTENDED	OVER REAR	5000	42
33	MAIN BOOM	68% EXTENDED	OVER REAR	3750	43
34	MAIN BOOM	68% EXTENDED	OVER REAR	2500	44
35	MAIN BOOM	68% EXTENDED	OVER REAR	1250	45
36	MAIN BOOM	68% EXTENDED	OVER REAR	0	46
37	MAIN BOOM	50% EXTENDED	FULL 360°	10000	47
38	MAIN BOOM	50% EXTENDED	FULL 360°	8750	48
39	MAIN BOOM	50% EXTENDED	FULL 360°	7500	49
40	MAIN BOOM	50% EXTENDED	FULL 360°	6250	50
41	MAIN BOOM	50% EXTENDED	FULL 360°	5000	51
42	MAIN BOOM	50% EXTENDED	FULL 360°	3750	52
43	MAIN BOOM	50% EXTENDED	FULL 360°	2500	53
44	MAIN BOOM	50% EXTENDED	FULL 360°	1250	54

<b>CODE</b>	<b>CRANE CONFIGURATION</b>	<b>OUTRIGGER CONFIGURATION</b>	<b>AREA OF OPERATION</b>	<b>CWT (LBS)</b>	<b>PAGE</b>
45	MAIN BOOM	50% EXTENDED	FULL 360°	0	55
46	MAIN BOOM	50% EXTENDED	OVER REAR	10000	56
47	MAIN BOOM	50% EXTENDED	OVER REAR	8750	57
48	MAIN BOOM	50% EXTENDED	OVER REAR	7500	58
49	MAIN BOOM	50% EXTENDED	OVER REAR	6250	59
50	MAIN BOOM	50% EXTENDED	OVER REAR	5000	60
51	MAIN BOOM	50% EXTENDED	OVER REAR	3750	61
52	MAIN BOOM	50% EXTENDED	OVER REAR	2500	62
53	MAIN BOOM	50% EXTENDED	OVER REAR	1250	63
54	MAIN BOOM	50% EXTENDED	OVER REAR	0	64
55	MAIN BOOM	RETRACTED	FULL 360°	10000	65
56	MAIN BOOM	RETRACTED	FULL 360°	8750	66
57	MAIN BOOM	RETRACTED	FULL 360°	7500	67
58	MAIN BOOM	RETRACTED	FULL 360°	6250	68
59	MAIN BOOM	RETRACTED	FULL 360°	5000	69
60	MAIN BOOM	RETRACTED	FULL 360°	3750	70
61	MAIN BOOM	RETRACTED	FULL 360°	2500	71
62	MAIN BOOM	RETRACTED	FULL 360°	1250	72
63	MAIN BOOM	RETRACTED	FULL 360°	0	73
64	RETRACTED JIB 0° OFFSET	100% EXTENDED	FULL 360°	10000	74
65	RETRACTED JIB 0° OFFSET	100% EXTENDED	FULL 360°	8750	75
66	RETRACTED JIB 0° OFFSET	100% EXTENDED	FULL 360°	7500	76
67	RETRACTED JIB 0° OFFSET	100% EXTENDED	FULL 360°	6250	77
68	RETRACTED JIB 0° OFFSET	100% EXTENDED	FULL 360°	5000	78
69	RETRACTED JIB 0° OFFSET	100% EXTENDED	FULL 360°	3750	79
70	RETRACTED JIB 0° OFFSET	100% EXTENDED	FULL 360°	2500	80
71	RETRACTED JIB 0° OFFSET	100% EXTENDED	FULL 360°	1250	81
72	RETRACTED JIB 0° OFFSET	100% EXTENDED	FULL 360°	0	82
73	RETRACTED JIB 15° OFFSET	100% EXTENDED	FULL 360°	10000	74
74	RETRACTED JIB 15° OFFSET	100% EXTENDED	FULL 360°	8750	75
75	RETRACTED JIB 15° OFFSET	100% EXTENDED	FULL 360°	7500	76
76	RETRACTED JIB 15° OFFSET	100% EXTENDED	FULL 360°	6250	77
77	RETRACTED JIB 15° OFFSET	100% EXTENDED	FULL 360°	5000	78
78	RETRACTED JIB 15° OFFSET	100% EXTENDED	FULL 360°	3750	79
79	RETRACTED JIB 15° OFFSET	100% EXTENDED	FULL 360°	2500	80
80	RETRACTED JIB 15° OFFSET	100% EXTENDED	FULL 360°	1250	81
81	RETRACTED JIB 15° OFFSET	100% EXTENDED	FULL 360°	0	82
82	RETRACTED JIB 30° OFFSET	100% EXTENDED	FULL 360°	10000	74
83	RETRACTED JIB 30° OFFSET	100% EXTENDED	FULL 360°	8750	75
84	RETRACTED JIB 30° OFFSET	100% EXTENDED	FULL 360°	7500	76
85	RETRACTED JIB 30° OFFSET	100% EXTENDED	FULL 360°	6250	77
86	RETRACTED JIB 30° OFFSET	100% EXTENDED	FULL 360°	5000	78
87	RETRACTED JIB 30° OFFSET	100% EXTENDED	FULL 360°	3750	79
88	RETRACTED JIB 30° OFFSET	100% EXTENDED	FULL 360°	2500	80
89	RETRACTED JIB 30° OFFSET	100% EXTENDED	FULL 360°	1250	81
90	RETRACTED JIB 30° OFFSET	100% EXTENDED	FULL 360°	0	82

<b>CODE</b>	<b>CRANE CONFIGURATION</b>	<b>OUTRIGGER CONFIGURATION</b>	<b>AREA OF OPERATION</b>	<b>CWT (LBS)</b>	<b>PAGE</b>
91	RETRACTED JIB 0° OFFSET	100% EXTENDED	OVER REAR	10000	74
92	RETRACTED JIB 0° OFFSET	100% EXTENDED	OVER REAR	8750	75
93	RETRACTED JIB 0° OFFSET	100% EXTENDED	OVER REAR	7500	76
94	RETRACTED JIB 0° OFFSET	100% EXTENDED	OVER REAR	6250	77
95	RETRACTED JIB 0° OFFSET	100% EXTENDED	OVER REAR	5000	78
96	RETRACTED JIB 0° OFFSET	100% EXTENDED	OVER REAR	3750	79
97	RETRACTED JIB 0° OFFSET	100% EXTENDED	OVER REAR	2500	80
98	RETRACTED JIB 0° OFFSET	100% EXTENDED	OVER REAR	1250	81
99	RETRACTED JIB 0° OFFSET	100% EXTENDED	OVER REAR	0	82
100	RETRACTED JIB 15° OFFSET	100% EXTENDED	OVER REAR	10000	74
101	RETRACTED JIB 15° OFFSET	100% EXTENDED	OVER REAR	8750	75
102	RETRACTED JIB 15° OFFSET	100% EXTENDED	OVER REAR	7500	76
103	RETRACTED JIB 15° OFFSET	100% EXTENDED	OVER REAR	6250	77
104	RETRACTED JIB 15° OFFSET	100% EXTENDED	OVER REAR	5000	78
105	RETRACTED JIB 15° OFFSET	100% EXTENDED	OVER REAR	3750	79
106	RETRACTED JIB 15° OFFSET	100% EXTENDED	OVER REAR	2500	80
107	RETRACTED JIB 15° OFFSET	100% EXTENDED	OVER REAR	1250	81
108	RETRACTED JIB 15° OFFSET	100% EXTENDED	OVER REAR	0	82
109	RETRACTED JIB 30° OFFSET	100% EXTENDED	OVER REAR	10000	74
110	RETRACTED JIB 30° OFFSET	100% EXTENDED	OVER REAR	8750	75
111	RETRACTED JIB 30° OFFSET	100% EXTENDED	OVER REAR	7500	76
112	RETRACTED JIB 30° OFFSET	100% EXTENDED	OVER REAR	6250	77
113	RETRACTED JIB 30° OFFSET	100% EXTENDED	OVER REAR	5000	78
114	RETRACTED JIB 30° OFFSET	100% EXTENDED	OVER REAR	3750	79
115	RETRACTED JIB 30° OFFSET	100% EXTENDED	OVER REAR	2500	80
116	RETRACTED JIB 30° OFFSET	100% EXTENDED	OVER REAR	1250	81
117	RETRACTED JIB 30° OFFSET	100% EXTENDED	OVER REAR	0	82
118	EXTENDED JIB 0° OFFSET	100% EXTENDED	FULL 360°	10000	83
119	EXTENDED JIB 0° OFFSET	100% EXTENDED	FULL 360°	8750	84
120	EXTENDED JIB 0° OFFSET	100% EXTENDED	FULL 360°	7500	85
121	EXTENDED JIB 0° OFFSET	100% EXTENDED	FULL 360°	6250	86
122	EXTENDED JIB 0° OFFSET	100% EXTENDED	FULL 360°	5000	87
123	EXTENDED JIB 0° OFFSET	100% EXTENDED	FULL 360°	3750	88
124	EXTENDED JIB 0° OFFSET	100% EXTENDED	FULL 360°	2500	89
125	EXTENDED JIB 0° OFFSET	100% EXTENDED	FULL 360°	1250	90
126	EXTENDED JIB 0° OFFSET	100% EXTENDED	FULL 360°	0	91
127	EXTENDED JIB 15° OFFSET	100% EXTENDED	FULL 360°	10000	83
128	EXTENDED JIB 15° OFFSET	100% EXTENDED	FULL 360°	8750	84
129	EXTENDED JIB 15° OFFSET	100% EXTENDED	FULL 360°	7500	85
130	EXTENDED JIB 15° OFFSET	100% EXTENDED	FULL 360°	6250	86
131	EXTENDED JIB 15° OFFSET	100% EXTENDED	FULL 360°	5000	87
132	EXTENDED JIB 15° OFFSET	100% EXTENDED	FULL 360°	3750	88
133	EXTENDED JIB 15° OFFSET	100% EXTENDED	FULL 360°	2500	89
134	EXTENDED JIB 15° OFFSET	100% EXTENDED	FULL 360°	1250	90
135	EXTENDED JIB 15° OFFSET	100% EXTENDED	FULL 360°	0	91
136	EXTENDED JIB 30° OFFSET	100% EXTENDED	FULL 360°	10000	83

<b>CODE</b>	<b>CRANE CONFIGURATION</b>	<b>OUTRIGGER CONFIGURATION</b>	<b>AREA OF OPERATION</b>	<b>CWT (LBS)</b>	<b>PAGE</b>
137	EXTENDED JIB 30° OFFSET	100% EXTENDED	FULL 360°	8750	84
138	EXTENDED JIB 30° OFFSET	100% EXTENDED	FULL 360°	7500	85
139	EXTENDED JIB 30° OFFSET	100% EXTENDED	FULL 360°	6250	86
140	EXTENDED JIB 30° OFFSET	100% EXTENDED	FULL 360°	5000	87
141	EXTENDED JIB 30° OFFSET	100% EXTENDED	FULL 360°	3750	88
142	EXTENDED JIB 30° OFFSET	100% EXTENDED	FULL 360°	2500	89
143	EXTENDED JIB 30° OFFSET	100% EXTENDED	FULL 360°	1250	90
144	EXTENDED JIB 30° OFFSET	100% EXTENDED	FULL 360°	0	91
145	EXTENDED JIB 0° OFFSET	100% EXTENDED	OVER REAR	10000	83
146	EXTENDED JIB 0° OFFSET	100% EXTENDED	OVER REAR	8750	84
147	EXTENDED JIB 0° OFFSET	100% EXTENDED	OVER REAR	7500	85
148	EXTENDED JIB 0° OFFSET	100% EXTENDED	OVER REAR	6250	86
149	EXTENDED JIB 0° OFFSET	100% EXTENDED	OVER REAR	5000	87
150	EXTENDED JIB 0° OFFSET	100% EXTENDED	OVER REAR	3750	88
151	EXTENDED JIB 0° OFFSET	100% EXTENDED	OVER REAR	2500	89
152	EXTENDED JIB 0° OFFSET	100% EXTENDED	OVER REAR	1250	90
153	EXTENDED JIB 0° OFFSET	100% EXTENDED	OVER REAR	0	91
154	EXTENDED JIB 15° OFFSET	100% EXTENDED	OVER REAR	10000	83
155	EXTENDED JIB 15° OFFSET	100% EXTENDED	OVER REAR	8750	84
156	EXTENDED JIB 15° OFFSET	100% EXTENDED	OVER REAR	7500	85
157	EXTENDED JIB 15° OFFSET	100% EXTENDED	OVER REAR	6250	86
158	EXTENDED JIB 15° OFFSET	100% EXTENDED	OVER REAR	5000	87
159	EXTENDED JIB 15° OFFSET	100% EXTENDED	OVER REAR	3750	88
160	EXTENDED JIB 15° OFFSET	100% EXTENDED	OVER REAR	2500	89
161	EXTENDED JIB 15° OFFSET	100% EXTENDED	OVER REAR	1250	90
162	EXTENDED JIB 15° OFFSET	100% EXTENDED	OVER REAR	0	91
163	EXTENDED JIB 30° OFFSET	100% EXTENDED	OVER REAR	10000	83
164	EXTENDED JIB 30° OFFSET	100% EXTENDED	OVER REAR	8750	84
165	EXTENDED JIB 30° OFFSET	100% EXTENDED	OVER REAR	7500	85
166	EXTENDED JIB 30° OFFSET	100% EXTENDED	OVER REAR	6250	86
167	EXTENDED JIB 30° OFFSET	100% EXTENDED	OVER REAR	5000	87
168	EXTENDED JIB 30° OFFSET	100% EXTENDED	OVER REAR	3750	88
169	EXTENDED JIB 30° OFFSET	100% EXTENDED	OVER REAR	2500	89
170	EXTENDED JIB 30° OFFSET	100% EXTENDED	OVER REAR	1250	90
171	EXTENDED JIB 30° OFFSET	100% EXTENDED	OVER REAR	0	91
172	FIXED JIB 0° OFFSET	100% EXTENDED	FULL 360°	10000	92
173	FIXED JIB 0° OFFSET	100% EXTENDED	FULL 360°	8750	93
174	FIXED JIB 0° OFFSET	100% EXTENDED	FULL 360°	7500	94
175	FIXED JIB 0° OFFSET	100% EXTENDED	FULL 360°	6250	95
176	FIXED JIB 0° OFFSET	100% EXTENDED	FULL 360°	5000	96
177	FIXED JIB 0° OFFSET	100% EXTENDED	FULL 360°	3750	97
178	FIXED JIB 0° OFFSET	100% EXTENDED	FULL 360°	2500	98
179	FIXED JIB 0° OFFSET	100% EXTENDED	FULL 360°	1250	99
180	FIXED JIB 0° OFFSET	100% EXTENDED	FULL 360°	0	100
181	FIXED JIB 15° OFFSET	100% EXTENDED	FULL 360°	10000	92
182	FIXED JIB 15° OFFSET	100% EXTENDED	FULL 360°	8750	93

<b>CODE</b>	<b>CRANE CONFIGURATION</b>	<b>OUTRIGGER CONFIGURATION</b>	<b>AREA OF OPERATION</b>	<b>CWT (LBS)</b>	<b>PAGE</b>
183----	FIXED JIB 15° OFFSET-----	100% EXTENDED-----	FULL 360°-----	7500-----	94
184----	FIXED JIB 15° OFFSET-----	100% EXTENDED-----	FULL 360°-----	6250-----	95
185----	FIXED JIB 15° OFFSET-----	100% EXTENDED-----	FULL 360°-----	5000-----	96
186----	FIXED JIB 15° OFFSET-----	100% EXTENDED-----	FULL 360°-----	3750-----	97
187----	FIXED JIB 15° OFFSET-----	100% EXTENDED-----	FULL 360°-----	2500-----	98
188----	FIXED JIB 15° OFFSET-----	100% EXTENDED-----	FULL 360°-----	1250-----	99
189----	FIXED JIB 15° OFFSET-----	100% EXTENDED-----	FULL 360°-----	0-----	100
190----	FIXED JIB 30° OFFSET-----	100% EXTENDED-----	FULL 360°-----	10000-----	92
191----	FIXED JIB 30° OFFSET-----	100% EXTENDED-----	FULL 360°-----	8750-----	93
192----	FIXED JIB 30° OFFSET-----	100% EXTENDED-----	FULL 360°-----	7500-----	94
193----	FIXED JIB 30° OFFSET-----	100% EXTENDED-----	FULL 360°-----	6250-----	95
194----	FIXED JIB 30° OFFSET-----	100% EXTENDED-----	FULL 360°-----	5000-----	96
195----	FIXED JIB 30° OFFSET-----	100% EXTENDED-----	FULL 360°-----	3750-----	97
196----	FIXED JIB 30° OFFSET-----	100% EXTENDED-----	FULL 360°-----	2500-----	98
197----	FIXED JIB 30° OFFSET-----	100% EXTENDED-----	FULL 360°-----	1250-----	99
198----	FIXED JIB 30° OFFSET-----	100% EXTENDED-----	FULL 360°-----	0-----	100
199----	FIXED JIB 0° OFFSET-----	100% EXTENDED-----	OVER REAR-----	10000-----	92
200----	FIXED JIB 0° OFFSET-----	100% EXTENDED-----	OVER REAR-----	8750-----	93
201----	FIXED JIB 0° OFFSET-----	100% EXTENDED-----	OVER REAR-----	7500-----	94
202----	FIXED JIB 0° OFFSET-----	100% EXTENDED-----	OVER REAR-----	6250-----	95
203----	FIXED JIB 0° OFFSET-----	100% EXTENDED-----	OVER REAR-----	5000-----	96
204----	FIXED JIB 0° OFFSET-----	100% EXTENDED-----	OVER REAR-----	3750-----	97
205----	FIXED JIB 0° OFFSET-----	100% EXTENDED-----	OVER REAR-----	2500-----	98
206----	FIXED JIB 0° OFFSET-----	100% EXTENDED-----	OVER REAR-----	1250-----	99
207----	FIXED JIB 0° OFFSET-----	100% EXTENDED-----	OVER REAR-----	0-----	100
208----	FIXED JIB 15° OFFSET-----	100% EXTENDED-----	OVER REAR-----	10000-----	92
209----	FIXED JIB 15° OFFSET-----	100% EXTENDED-----	OVER REAR-----	8750-----	93
210----	FIXED JIB 15° OFFSET-----	100% EXTENDED-----	OVER REAR-----	7500-----	94
211----	FIXED JIB 15° OFFSET-----	100% EXTENDED-----	OVER REAR-----	6250-----	95
212----	FIXED JIB 15° OFFSET-----	100% EXTENDED-----	OVER REAR-----	5000-----	96
213----	FIXED JIB 15° OFFSET-----	100% EXTENDED-----	OVER REAR-----	3750-----	97
214----	FIXED JIB 15° OFFSET-----	100% EXTENDED-----	OVER REAR-----	2500-----	98
215----	FIXED JIB 15° OFFSET-----	100% EXTENDED-----	OVER REAR-----	1250-----	99
216----	FIXED JIB 15° OFFSET-----	100% EXTENDED-----	OVER REAR-----	0-----	100
217----	FIXED JIB 30° OFFSET-----	100% EXTENDED-----	OVER REAR-----	10000-----	92
218----	FIXED JIB 30° OFFSET-----	100% EXTENDED-----	OVER REAR-----	8750-----	93
219----	FIXED JIB 30° OFFSET-----	100% EXTENDED-----	OVER REAR-----	7500-----	94
220----	FIXED JIB 30° OFFSET-----	100% EXTENDED-----	OVER REAR-----	6250-----	95
221----	FIXED JIB 30° OFFSET-----	100% EXTENDED-----	OVER REAR-----	5000-----	96
222----	FIXED JIB 30° OFFSET-----	100% EXTENDED-----	OVER REAR-----	3750-----	97
223----	FIXED JIB 30° OFFSET-----	100% EXTENDED-----	OVER REAR-----	2500-----	98
224----	FIXED JIB 30° OFFSET-----	100% EXTENDED-----	OVER REAR-----	1250-----	99
225----	FIXED JIB 30° OFFSET-----	100% EXTENDED-----	OVER REAR-----	0-----	100

## **WARNING**





1. THE OPERATOR MUST READ AND UNDERSTAND THE OWNER'S MANUAL BEFORE OPERATING THIS CRANE.
2. POSITIONING OR OPERATION OF CRANE BEYOND AREAS SHOWN ON THIS CHART IS NOT INTENDED OR APPROVED EXCEPT WHERE SPECIFIED IN OWNER'S MANUAL. SHADED LOADS ARE STABILITY LIMITED.
3. LOADED BOOM ANGLES AT SPECIFIED BOOM LENGTHS GIVE ONLY AN APPROXIMATION OF THE OPERATING RADIUS. THE BOOM ANGLE BEFORE LOADING SHOULD BE GREATER TO ACCOUNT FOR DEFLECTIONS. DO NOT EXCEED THE OPERATING RADIUS FOR RATED LOADS.
4. THE OPERATING RADIUS SHOWN IN THE JIB RATING CHART IS FOR 100% EXTENDED BOOM ONLY. WHEN BOOM IS NOT 100% EXTENDED, USE ONLY LOADED BOOM ANGLE TO DETERMINE LOAD RATING OF JIB.
5. FOR BOOM ANGLES NOT SHOWN ON JIB LOAD CHART, USE RATING OF NEXT LOWER BOOM ANGLE.
6. FOR BOOM LENGTHS NOT SHOWN, USE RATING OF NEXT SHORTER OR LONGER BOOM LENGTH, WHICHEVER IS LESS. FOR RADII NOT SHOWN, USE RATING OF NEXT LONGER RADIUS.
7. CRANE LOAD RATINGS ON OUTRIGGERS ARE BASED ON FREELY SUSPENDED LOADS WITH THE MACHINE LEVELED AND STANDING ON A FIRM UNIFORM SUPPORTING SURFACE. NO ATTEMPT SHALL BE MADE TO MOVE A LOAD HORIZONTALLY ON THE GROUND IN ANY DIRECTION.
8. PRACTICAL WORKING LOADS DEPEND ON SUPPORTING SURFACE, WIND AND OTHER FACTORS AFFECTING STABILITY SUCH AS HAZARDOUS SURROUNDINGS, EXPERIENCE OF PERSONNEL AND PROPER HANDLING, ALL OF WHICH MUST BE TAKEN INTO ACCOUNT BY THE OPERATOR.
9. THE MAXIMUM LOAD WHICH MAY BE TELESCOPED IS LIMITED BY HYDRAULIC PRESSURE, BOOM ANGLE AND BOOM LUBRICATION. IT IS SAFE TO ATTEMPT TO TELESCOPE ANY LOAD WITHIN THE LIMITS OF THE LOAD RATING CHART.

## **INFORMATION**

1. DEDUCTIONS MUST BE MADE FROM RATED LOADS FOR JIB, OPTIONAL ATTACHMENTS, HOOKS AND LOADBLOCKS (SEE DEDUCTION CHART). WEIGHTS OF SLINGS AND ALL OTHER LOAD HANDLING DEVICES SHALL BE CONSIDERED AS PART OF THE LOAD.
2. LOAD RATINGS ABOVE THE HEAVY LINE ARE STRUCTURALLY LIMITED CAPACITIES. LOAD RATINGS BELOW THE HEAVY LINE ARE STABILITY LIMITED CAPACITIES AND DO NOT EXCEED 85% OF TIPPING.

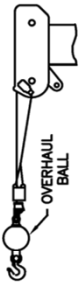
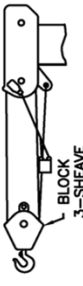
## **DEFINITIONS**

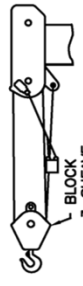
1. OPERATING RADIUS IS THE HORIZONTAL DISTANCE FROM THE AXIS OF ROTATION TO THE CENTER OF THE VERTICAL HOIST LINE OR TACKLE WITH LOAD APPLIED.
2. LOADED BOOM ANGLE IS THE INCLUDED ANGLE BETWEEN THE HORIZONTAL AND LONGITUDINAL AXES OF THE BOOM BASE AFTER LIFTING RATED LOAD AT THE RATED RADIUS.

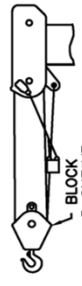
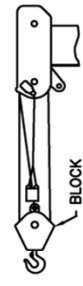
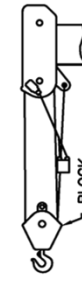
ALLOWABLE LINE PULL								<b>WARNING</b>
1 PART LINE	2 PART LINE	3 PART LINE	4 PART LINE	5 PART LINE	6 PART LINE	7 PART LINE	8 PART LINE	
								
12000 LBS	24000 LBS	36000 LBS	48000 LBS	60000 LBS	72000 LBS	84000 LBS	90000 LBS	
								ANTI-TWO-BLOCK SYSTEM MUST BE IN GOOD OPERATING CONDITION BEFORE OPERATING CRANE.  REFER TO THE OWNER'S MANUAL.  KEEP AT LEAST 3 WRAPS OF LOAD LINE ON THE DRUM AT ALL TIMES.  5/8" ROT RESISTANT (5:1 SF) 61,200 LBS MIN BREAKING STRENGTH

## AREA OF OPERATIONS

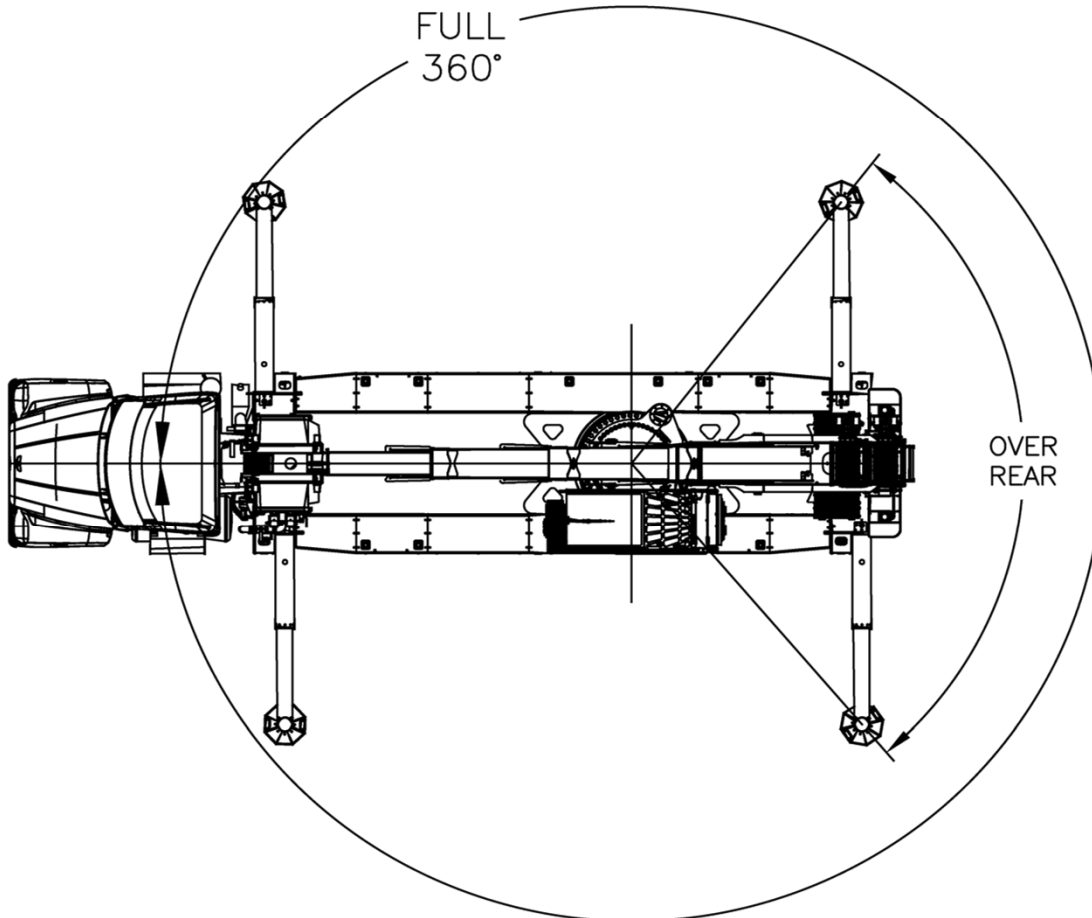

### DEDUCTIONS FROM RATED LOADS FOR LOAD HANDLING DEVICES SUPPLIED BY MANITEX

AUXILIARY BLOCK-----	50 LBS
AUXILIARY (ROOSTER) SHEAVE-----	70 LBS
LIFTING FROM MAIN BOOM WITH JIB STOWED OR ERECTED-----	SEE LOAD CHART
OVERHAUL BALL-----	SEE MANUFACTURER NAMEPLATE
LOAD BLOCK-----	SEE MANUFACTURER NAMEPLATE



**- RANGE DIAGRAM -**

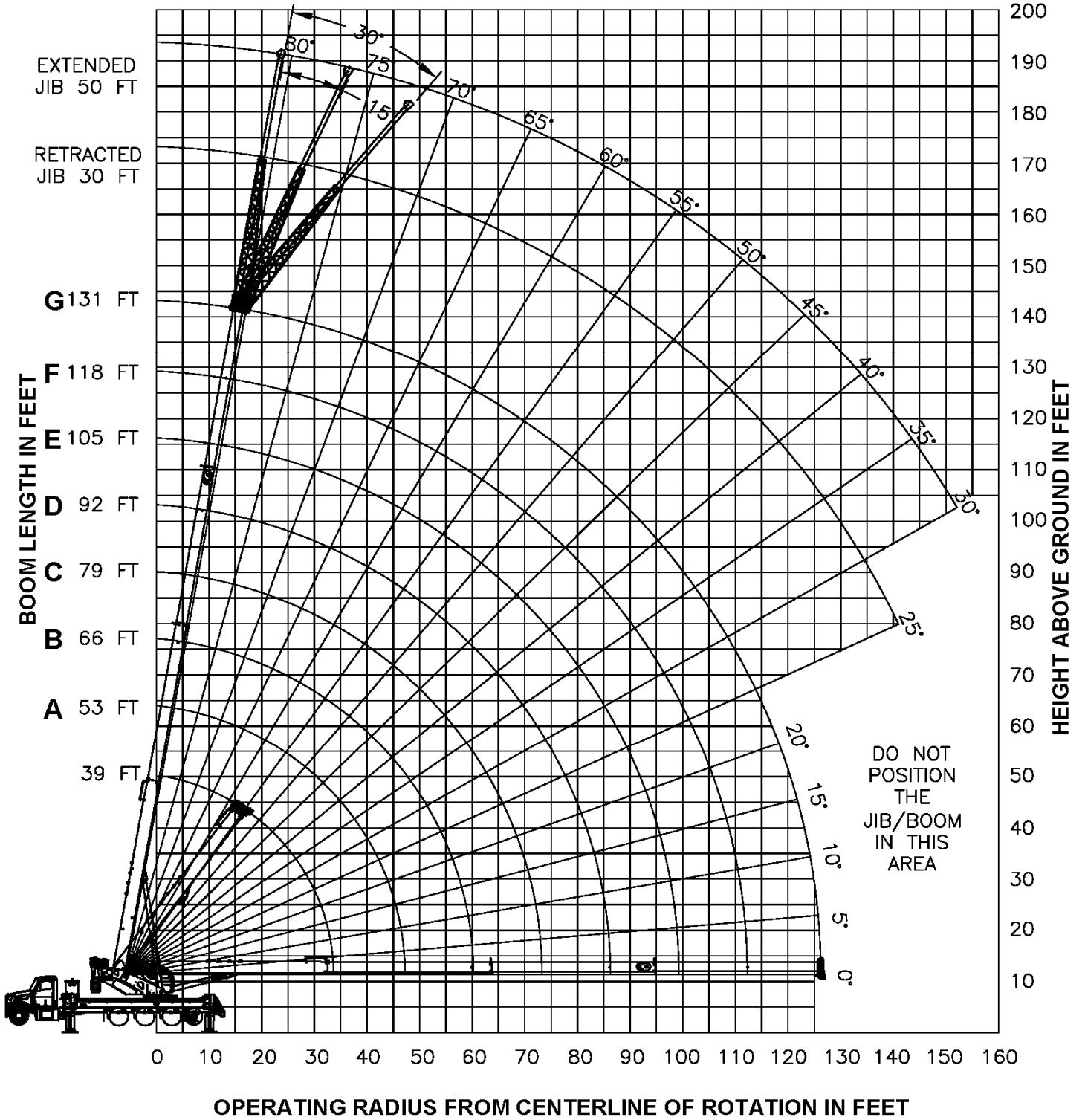

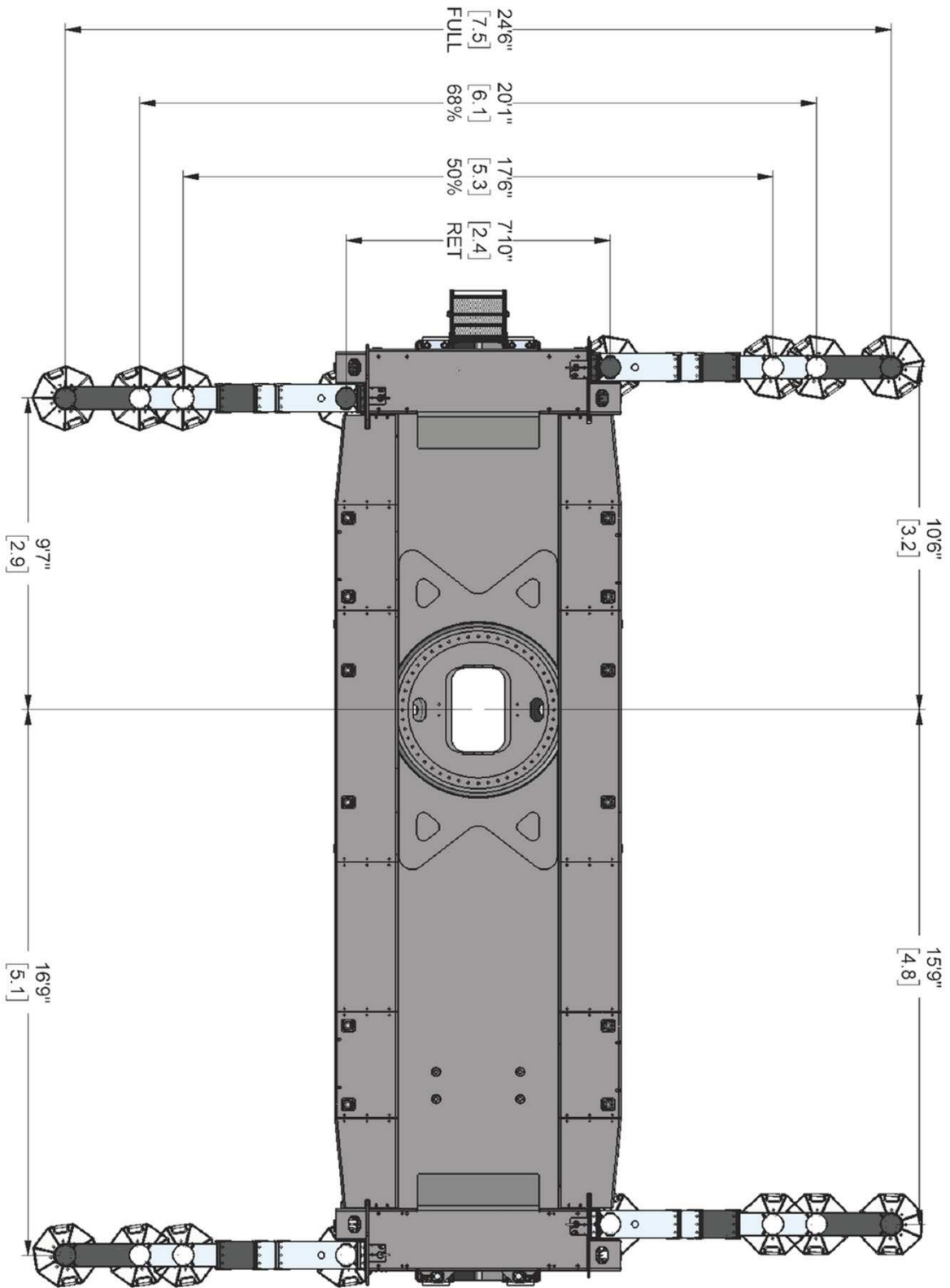

*Dimensions are in feet [meters] unless otherwise specified*

# CODE 1

## MAIN BOOM



LOAD RADIUS (FT)	ANGLE	LIFTING CAP. (LBS)	ANGLE	LIFTING CAP. (LBS)	ANGLE	LIFTING CAP. (LBS)	ANGLE	LIFTING CAP. (LBS)	ANGLE	LIFTING CAP. (LBS)	ANGLE	LIFTING CAP. (LBS)	ANGLE	LIFTING CAP. (LBS)	ANGLE	LIFTING CAP. (LBS)	LOAD RADIUS (FT)
LENGTH	39.3 FT		53 FT		66 FT		79 FT		92 FT		105 FT		118 FT		131 FT		
6	74°	90000															6
8	70°	90000															8
10	67°	90000	74°	79200	77°	72400											10
12	64°	90000	71°	79200	76°	68300	78°	53900									12
15	59°	83200	68°	73500	73°	61800	76°	49100	79°	37600							15
20	50°	64800	62°	61700	68°	52500	72°	42600	75°	33100	78°	28700					20
25	40°	50300	55°	51200	63°	45500	69°	37100	72°	29100	75°	25500	77°	22500			25
30	26°	40400	49°	41400	58°	39800	65°	32900	69°	25700	72°	23100	75°	20500	77°	17900	30
35			41°	34000	53°	34700	61°	29300	66°	23200	69°	20700	73°	18600	75°	16600	35
40			31°	26400	47°	27100	56°	26100	62°	20700	66°	18700	70°	16900	73°	15200	40
45			18°	21100	41°	21800	52°	22200	58°	18700	63°	16900	67°	15300	70°	13900	45
50					35°	17900	47°	18300	55°	16900	60°	15300	65°	14000	68°	12700	50
55					28°	14900	41°	15300	51°	15400	57°	14000	62°	12800	66°	11900	55
60					18°	12500	35°	13000	46°	13200	54°	12700	59°	11900	63°	10900	60
65							28°	11000	42°	11300	50°	11500	56°	10900	61°	10000	65
70							18°	9400	36°	9700	46°	9900	53°	10000	58°	9200	70
75									30°	8400	42°	8600	50°	8700	55°	8500	75
80									23°	7200	38°	7400	46°	7600	52°	7700	80
85									11°	6200	33°	6400	43°	6600	49°	6700	85
90											27°	5600	39°	5700	46°	5800	90
95											19°	4800	34°	4900	43°	5000	95
100													29°	4200	39°	4300	100
105													23°	3600	36°	3700	105
110													14°	3000	31°	3100	110
115															26°	2600	115
120															19°	2200	120
125															6°	1700	125
130																	130
DEDUCTIONS FOR MAIN BOOM CAPACITIES	0°	30500	0°	18050	0°	12350	0°	8300	0°	5950	0°	4250	0°	2850	0°	600	
		1570		1140		920		770		660		580		520		460	STOWED
		3510		3240		3100		3010		2940		2890		2850		2820	RET
		3910		3530		3340		3200		3110		3040		2980		2940	EXT
	2620		2420		2320		2250		2200		2170		2140		2120	FIXED	

# CODE 2

## MAIN BOOM

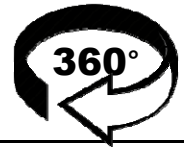
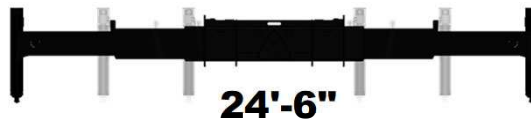

LOAD RADIUS (FT)	ANGLE	LIFTING CAP. (LBS)	ANGLE	LIFTING CAP. (LBS)	ANGLE	LIFTING CAP. (LBS)	ANGLE	LIFTING CAP. (LBS)	ANGLE	LIFTING CAP. (LBS)	ANGLE	LIFTING CAP. (LBS)	ANGLE	LIFTING CAP. (LBS)	ANGLE	LIFTING CAP. (LBS)	LOAD RADIUS (FT)
LENGTH	39.3 FT		53 FT		66 FT		79 FT		92 FT		105 FT		118 FT		131 FT		
6	74°	90000															6
8	70°	90000															8
10	67°	90000	74°	79200	77°	72400											10
12	64°	90000	71°	79200	76°	68300	78°	53900									12
15	59°	83200	68°	73500	73°	61800	76°	49100	79°	37600							15
20	50°	64200	62°	61700	68°	52500	72°	42600	75°	33100	78°	28700					20
25	40°	49700	55°	50700	63°	45500	69°	37100	72°	29100	75°	25500	77°	22500			25
30	26°	39900	49°	41000	58°	39800	65°	32900	69°	25700	72°	23100	75°	20500	77°	17900	30
35			41°	32900	53°	33600	61°	29300	66°	23200	69°	20700	73°	18600	75°	16600	35
40			31°	25500	47°	26200	56°	26100	62°	20700	66°	18700	70°	16900	73°	15200	40
45			18°	20300	41°	21100	52°	21500	58°	18700	63°	16900	67°	15300	70°	13900	45
50					35°	17300	47°	17700	55°	16900	60°	15300	65°	14000	68°	12700	50
55					28°	14300	41°	14800	51°	15000	57°	14000	62°	12800	66°	11900	55
60					18°	11900	35°	12500	46°	12700	54°	12700	59°	11900	63°	10900	60
65							28°	10600	42°	10800	50°	11000	56°	10900	61°	10000	65
70							18°	9000	36°	9300	46°	9500	53°	9600	58°	9200	70
75									30°	8000	42°	8200	50°	8300	55°	8400	75
80									23°	6900	38°	7100	46°	7200	52°	7300	80
85									11°	5800	33°	6100	43°	6200	49°	6300	85
90											27°	5200	39°	5300	46°	5500	90
95											19°	4400	34°	4600	43°	4700	95
100													29°	3900	39°	4000	100
105													23°	3300	36°	3400	105
110													14°	2700	31°	2800	110
115															26°	2300	115
120															19°	1900	120
125															6°	1500	125
130																	130
DEDUCTIONS FOR MAIN BOOM CAPACITIES	0°	30300	0°	17600	0°	11750	0°	8150	0°	5600	0°	3950	0°	2550	0°	600	
		1570		1140		920		770		660		580		520		460	STOWED
		3510		3240		3100		3010		2940		2890		2850		2820	RET
		3910		3530		3340		3200		3110		3040		2980		2940	EXT
	2620		2420		2320		2250		2200		2170		2140		2120	FIXED	

# CODE 3

## MAIN BOOM

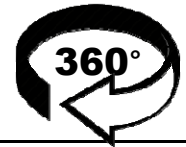

LOAD RADIUS (FT)	ANGLE	LIFTING CAP. (LBS)	ANGLE	LIFTING CAP. (LBS)	ANGLE	LIFTING CAP. (LBS)	ANGLE	LIFTING CAP. (LBS)	ANGLE	LIFTING CAP. (LBS)	ANGLE	LIFTING CAP. (LBS)	ANGLE	LIFTING CAP. (LBS)	ANGLE	LIFTING CAP. (LBS)	LOAD RADIUS (FT)
LENGTH	39.3 FT		53 FT		66 FT		79 FT		92 FT		105 FT		118 FT		131 FT		
6	74°	90000															6
8	70°	90000															8
10	67°	90000	74°	79200	77°	72400											10
12	64°	90000	71°	79200	76°	68300	78°	53900									12
15	59°	83200	68°	73500	73°	61800	76°	49100	79°	37600							15
20	50°	63500	62°	61700	68°	52500	72°	42600	75°	33100	78°	28700					20
25	40°	49200	55°	50200	63°	45500	69°	37100	72°	29100	75°	25500	77°	22500			25
30	26°	39500	49°	40500	58°	39800	65°	32900	69°	25700	72°	23100	75°	20500	77°	17900	30
35			41°	31800	53°	32500	61°	29300	66°	23200	69°	20700	73°	18600	75°	16600	35
40			31°	24600	47°	25300	56°	25700	62°	20700	66°	18700	70°	16900	73°	15200	40
45			18°	19600	41°	20300	52°	20700	58°	18700	63°	16900	67°	15300	70°	13900	45
50					35°	16600	47°	17000	55°	16900	60°	15300	65°	14000	68°	12700	50
55					28°	13800	41°	14200	51°	14500	57°	14000	62°	12800	66°	11900	55
60					18°	11400	35°	11900	46°	12200	54°	12400	59°	11900	63°	10900	60
65							28°	10100	42°	10400	50°	10600	56°	10700	61°	10000	65
70							18°	8600	36°	8900	46°	9100	53°	9200	58°	9200	70
75									30°	7600	42°	7800	50°	7900	55°	8000	75
80									23°	6400	38°	6700	46°	6800	52°	6900	80
85									11°	5400	33°	5700	43°	5800	49°	5900	85
90											27°	4800	39°	4900	46°	5100	90
95											19°	4000	34°	4200	43°	4300	95
100													29°	3500	39°	3700	100
105													23°	2900	36°	3100	105
110													14°	2400	31°	2500	110
115															26°	2000	115
120															19°	1600	120
125															6°	1200	125
130																	130
DEDUCTIONS FOR MAIN BOOM CAPACITIES	0°	30100	0°	17250	0°	11300	0°	7800	0°	5250	0°	3650	0°	2300	0°	600	
		1570		1140		920		770		660		580		520		460	STOWED
		3510		3240		3100		3010		2940		2890		2850		2820	RET
		3910		3530		3340		3200		3110		3040		2980		2940	EXT
	2620		2420		2320		2250		2200		2170		2140		2120	FIXED	

# CODE 4

## MAIN BOOM

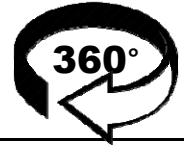
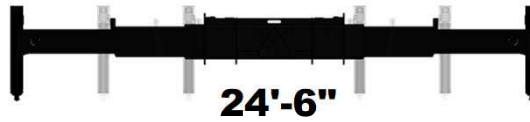

LOAD RADIUS (FT)	ANGLE	LIFTING CAP. (LBS)	ANGLE	LIFTING CAP. (LBS)	ANGLE	LIFTING CAP. (LBS)	ANGLE	LIFTING CAP. (LBS)	ANGLE	LIFTING CAP. (LBS)	ANGLE	LIFTING CAP. (LBS)	ANGLE	LIFTING CAP. (LBS)	ANGLE	LIFTING CAP. (LBS)	LOAD RADIUS (FT)
LENGTH	39.3 FT		53 FT		66 FT		79 FT		92 FT		105 FT		118 FT		131 FT		
6	74°	90000															6
8	70°	90000															8
10	67°	90000	74°	79200	77°	72400											10
12	64°	90000	71°	79200	76°	68300	78°	53900									12
15	59°	83200	68°	73500	73°	61800	76°	49100	79°	37600							15
20	50°	62900	62°	61700	68°	52500	72°	42600	75°	33100	78°	28700					20
25	40°	48700	55°	49700	63°	45500	69°	37100	72°	29100	75°	25500	77°	22500			25
30	26°	39000	49°	40100	58°	39800	65°	32900	69°	25700	72°	23100	75°	20500	77°	17900	30
35			41°	30700	53°	31400	61°	29300	66°	23200	69°	20700	73°	18600	75°	16600	35
40			31°	23700	47°	24400	56°	24900	62°	20700	66°	18700	70°	16900	73°	15200	40
45			18°	18800	41°	19600	52°	20000	58°	18700	63°	16900	67°	15300	70°	13900	45
50					35°	16000	47°	16400	55°	16700	60°	15300	65°	14000	68°	12700	50
55					28°	13200	41°	13600	51°	13900	57°	14000	62°	12800	66°	11900	55
60					18°	10900	35°	11400	46°	11700	54°	11900	59°	11900	63°	10900	60
65							28°	9600	42°	9900	50°	10100	56°	10200	61°	10000	65
70							18°	8100	36°	8400	46°	8600	53°	8800	58°	8900	70
75									30°	7100	42°	7300	50°	7500	55°	7600	75
80									23°	6000	38°	6200	46°	6400	52°	6500	80
85									11°	5000	33°	5200	43°	5400	49°	5500	85
90											27°	4400	39°	4600	46°	4700	90
95											19°	3700	34°	3800	43°	3900	95
100													29°	3200	39°	3300	100
105													23°	2600	36°	2700	105
110													14°	2100	31°	2200	110
115															26°	1800	115
120															19°	1300	120
125															6°	900	125
130																	130
DEDUCTIONS FOR MAIN BOOM CAPACITIES	0°	29850	0°	16800	0°	10800	0°	7350	0°	4850	0°	3350	0°	2000	0°	600	
		1570		1140		920		770		660		580		520		460	STOWED
		3510		3240		3100		3010		2940		2890		2850		2820	RET
		3910		3530		3340		3200		3110		3040		2980		2940	EXT
	2620		2420		2320		2250		2200		2170		2140		2120	FIXED	

# CODE 5

## MAIN BOOM

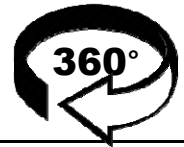

LOAD RADIUS (FT)	ANGLE	LIFTING CAP. (LBS)	ANGLE	LIFTING CAP. (LBS)	ANGLE	LIFTING CAP. (LBS)	ANGLE	LIFTING CAP. (LBS)	ANGLE	LIFTING CAP. (LBS)	ANGLE	LIFTING CAP. (LBS)	ANGLE	LIFTING CAP. (LBS)	ANGLE	LIFTING CAP. (LBS)	LOAD RADIUS (FT)
LENGTH	39.3 FT		53 FT		66 FT		79 FT		92 FT		105 FT		118 FT		131 FT		
6	74°	90000															6
8	70°	90000															8
10	67°	90000	74°	79200	77°	72400											10
12	64°	90000	71°	79200	76°	68300	78°	53900									12
15	59°	83200	68°	73500	73°	61800	76°	49100	79°	37600							15
20	50°	62300	62°	61700	68°	52500	72°	42600	75°	33100	78°	28700					20
25	40°	48200	55°	49200	63°	45500	69°	37100	72°	29100	75°	25500	77°	22500			25
30	26°	38600	49°	39600	58°	39800	65°	32900	69°	25700	72°	23100	75°	20500	77°	17900	30
35			41°	29600	53°	30300	61°	29300	66°	23200	69°	20700	73°	18600	75°	16600	35
40			31°	22800	47°	23500	56°	24000	62°	20700	66°	18700	70°	16900	73°	15200	40
45			18°	18100	41°	18800	52°	19200	58°	18700	63°	16900	67°	15300	70°	13900	45
50					35°	15300	47°	15700	55°	16000	60°	15300	65°	14000	68°	12700	50
55					28°	12600	41°	13000	51°	13300	57°	13500	62°	12800	66°	11900	55
60					18°	10400	35°	10900	46°	11200	54°	11400	59°	11500	63°	10900	60
65							28°	9100	42°	9400	50°	9600	56°	9800	61°	9900	65
70							18°	7600	36°	7900	46°	8100	53°	8300	58°	8400	70
75									30°	6600	42°	6800	50°	7000	55°	7100	75
80									23°	5500	38°	5800	46°	5900	52°	6000	80
85									11°	4600	33°	4800	43°	5000	49°	5100	85
90											27°	4000	39°	4200	46°	4300	90
95											19°	3300	34°	3500	43°	3600	95
100													29°	2800	39°	3000	100
105													23°	2300	36°	2400	105
110													14°	1800	31°	1900	110
115															26°	1500	115
120															19°	1100	120
125																	125
130																	130
DEDUCTIONS FOR MAIN BOOM CAPACITIES	0°	29700	0°	16400	0°	10300	0°	6900	0°	4450	0°	3050	0°	1750	0°	600	
		1570		1140		920		770		660		580		520		460	STOWED
		3510		3240		3100		3010		2940		2890		2850		2820	RET
		3910		3530		3340		3200		3110		3040		2980		2940	EXT
	2620		2420		2320		2250		2200		2170		2140		2120	FIXED	

# CODE 6

## MAIN BOOM

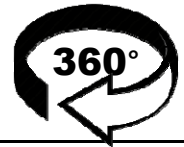

LOAD RADIUS (FT)	ANGLE	LIFTING CAP. (LBS)	ANGLE	LIFTING CAP. (LBS)	ANGLE	LIFTING CAP. (LBS)	ANGLE	LIFTING CAP. (LBS)	ANGLE	LIFTING CAP. (LBS)	ANGLE	LIFTING CAP. (LBS)	ANGLE	LIFTING CAP. (LBS)	ANGLE	LIFTING CAP. (LBS)	LOAD RADIUS (FT)
LENGTH	39.3 FT		53 FT		66 FT		79 FT		92 FT		105 FT		118 FT		131 FT		
6	74°	90000															6
8	70°	90000															8
10	67°	90000	74°	79200	77°	72400											10
12	64°	90000	71°	79200	76°	68300	78°	53900									12
15	59°	83200	68°	73500	73°	61800	76°	49100	79°	37600							15
20	50°	61600	62°	61700	68°	52500	72°	42600	75°	33100	78°	28700					20
25	40°	47700	55°	48600	63°	45500	69°	37100	72°	29100	75°	25500	77°	22500			25
30	26°	37200	49°	38800	58°	39600	65°	32900	69°	25700	72°	23100	75°	20500	77°	17900	30
35			41°	28500	53°	29300	61°	29300	66°	23200	69°	20700	73°	18600	75°	16600	35
40			31°	21900	47°	22700	56°	23100	62°	20700	66°	18700	70°	16900	73°	15200	40
45			18°	17300	41°	18000	52°	18500	58°	18700	63°	16900	67°	15300	70°	13900	45
50					35°	14600	47°	15100	55°	15300	60°	15300	65°	14000	68°	12700	50
55					28°	12000	41°	12500	51°	12700	57°	12900	62°	12800	66°	11900	55
60					18°	9800	35°	10400	46°	10700	54°	10800	59°	11000	63°	10900	60
65							28°	8500	42°	8900	50°	9100	56°	9200	61°	9300	65
70							18°	7000	36°	7400	46°	7600	53°	7700	58°	7900	70
75									30°	6100	42°	6300	50°	6500	55°	6600	75
80									23°	5100	38°	5300	46°	5500	52°	5600	80
85									11°	4100	33°	4400	43°	4600	49°	4700	85
90											27°	3600	39°	3800	46°	3900	90
95											19°	2900	34°	3100	43°	3200	95
100													29°	2500	39°	2600	100
105													23°	2000	36°	2100	105
110													14°	1500	31°	1600	110
115															26°	1200	115
120															19°	800	120
125																	125
130																	130
DEDUCTIONS FOR MAIN BOOM CAPACITIES	0°	29050	0°	15850	0°	9700	0°	6450	0°	4000	0°	2750	0°	1450	0°	600	
		1570		1140		920		770		660		580		520		460	STOWED
		3510		3240		3100		3010		2940		2890		2850		2820	RET
		3910		3530		3340		3200		3110		3040		2980		2940	EXT
	2620		2420		2320		2250		2200		2170		2140		2120	FIXED	



# CODE 7

## MAIN BOOM

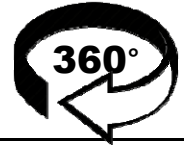

LOAD RADIUS (FT)	ANGLE	LIFTING CAP. (LBS)	ANGLE	LIFTING CAP. (LBS)	ANGLE	LIFTING CAP. (LBS)	ANGLE	LIFTING CAP. (LBS)	ANGLE	LIFTING CAP. (LBS)	ANGLE	LIFTING CAP. (LBS)	ANGLE	LIFTING CAP. (LBS)	ANGLE	LIFTING CAP. (LBS)	LOAD RADIUS (FT)
LENGTH	39.3 FT		53 FT		66 FT		79 FT		92 FT		105 FT		118 FT		131 FT		
6	74°	90000															6
8	70°	90000															8
10	67°	90000	74°	79200	77°	72400											10
12	64°	90000	71°	79200	76°	68300	78°	53900									12
15	59°	83200	68°	73500	73°	61800	76°	49100	79°	37600							15
20	50°	61000	62°	61700	68°	52500	72°	42600	75°	33100	78°	28700					20
25	40°	47100	55°	48100	63°	45500	69°	37100	72°	29100	75°	25500	77°	22500			25
30	26°	35800	49°	37400	58°	38200	65°	32900	69°	25700	72°	23100	75°	20500	77°	17900	30
35			41°	27400	53°	28200	61°	28600	66°	23200	69°	20700	73°	18600	75°	16600	35
40			31°	21000	47°	21800	56°	22200	62°	20700	66°	18700	70°	16900	73°	15200	40
45			18°	16600	41°	17300	52°	17700	58°	18000	63°	16900	67°	15300	70°	13900	45
50					35°	14000	47°	14400	55°	14700	60°	14900	65°	14000	68°	12700	50
55					28°	11400	41°	11900	51°	12100	57°	12300	62°	12500	66°	11900	55
60					18°	9100	35°	9700	46°	10000	54°	10200	59°	10400	63°	10500	60
65							28°	7900	42°	8300	50°	8500	56°	8600	61°	8800	65
70							18°	6500	36°	6800	46°	7000	53°	7200	58°	7300	70
75									30°	5600	42°	5900	50°	6000	55°	6100	75
80									23°	4600	38°	4800	46°	5000	52°	5100	80
85									11°	3700	33°	4000	43°	4100	49°	4200	85
90											27°	3200	39°	3400	46°	3500	90
95											19°	2600	34°	2700	43°	2900	95
100													29°	2200	39°	2300	100
105													23°	1600	36°	1800	105
110													14°	1200	31°	1300	110
115															26°	900	115
120																	120
125																	125
130																	130
DEDUCTIONS FOR MAIN BOOM CAPACITIES	0°	28450	0°	15200	0°	9000	0°	6000	0°	3650	0°	2450	0°	1200	0°	600	
		1570		1140		920		770		660		580		520		460	STOWED
		3510		3240		3100		3010		2940		2890		2850		2820	RET
		3910		3530		3340		3200		3110		3040		2980		2940	EXT
	2620		2420		2320		2250		2200		2170		2140		2120	FIXED	

# CODE 8

## MAIN BOOM

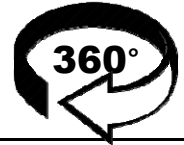

LOAD RADIUS (FT)	ANGLE	LIFTING CAP. (LBS)	ANGLE	LIFTING CAP. (LBS)	ANGLE	LIFTING CAP. (LBS)	ANGLE	LIFTING CAP. (LBS)	ANGLE	LIFTING CAP. (LBS)	ANGLE	LIFTING CAP. (LBS)	ANGLE	LIFTING CAP. (LBS)	ANGLE	LIFTING CAP. (LBS)	LOAD RADIUS (FT)
LENGTH	39.3 FT		53 FT		66 FT		79 FT		92 FT		105 FT		118 FT		131 FT		
6	74°	90000															6
8	70°	90000															8
10	67°	90000	74°	79200	77°	72400											10
12	64°	90000	71°	79200	76°	68300	78°	53900									12
15	59°	82700	68°	73500	73°	61800	76°	49100	79°	37600							15
20	50°	60300	62°	61300	68°	52500	72°	42600	75°	33100	78°	28700					20
25	40°	46600	55°	47600	63°	45500	69°	37100	72°	29100	75°	25500	77°	22500			25
30	26°	34400	49°	36000	58°	36800	65°	32900	69°	25700	72°	23100	75°	20500	77°	17900	30
35			41°	26400	53°	27100	61°	27500	66°	23200	69°	20700	73°	18600	75°	16600	35
40			31°	20200	47°	20900	56°	21300	62°	20700	66°	18700	70°	16900	73°	15200	40
45			18°	15800	41°	16500	52°	17000	58°	17200	63°	16900	67°	15300	70°	13900	45
50					35°	13300	47°	13800	55°	14000	60°	14200	65°	14000	68°	12700	50
55					28°	10700	41°	11200	51°	11500	57°	11700	62°	11800	66°	11900	55
60					18°	8500	35°	9000	46°	9400	54°	9600	59°	9700	63°	9900	60
65							28°	7400	42°	7700	50°	7900	56°	8000	61°	8200	65
70							18°	6000	36°	6300	46°	6500	53°	6700	58°	6800	70
75									30°	5100	42°	5400	50°	5500	55°	5600	75
80									23°	4200	38°	4400	46°	4500	52°	4700	80
85									11°	3300	33°	3600	43°	3700	49°	3800	85
90											27°	2800	39°	3000	46°	3100	90
95											19°	2200	34°	2400	43°	2500	95
100													29°	1800	39°	1900	100
105													23°	1300	36°	1400	105
110													14°	900	31°	1000	110
115																	115
120																	120
125																	125
130																	130
DEDUCTIONS FOR MAIN BOOM CAPACITIES	0°	27800	0°	14450	0°	8450	0°	5600	0°	3250	0°	2150	0°	450	0°	300	
		1570		1140		920		770		660		580		520		460	STOWED
		3510		3240		3100		3010		2940		2890		2850		2820	RET
		3910		3530		3340		3200		3110		3040		2980		2940	EXT
	2620		2420		2320		2250		2200		2170		2140		2120	FIXED	

# CODE 9

## MAIN BOOM

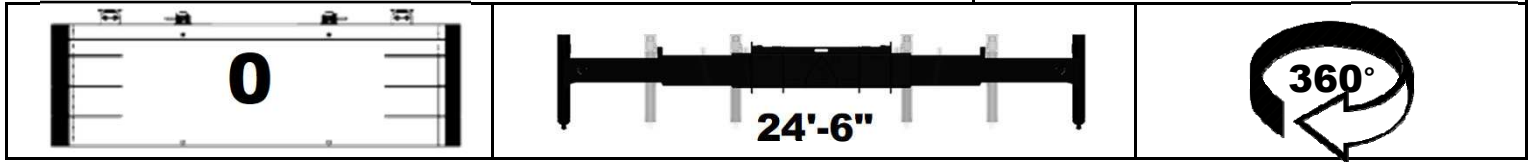

LOAD RADIUS (FT)	ANGLE	LIFTING CAP. (LBS)	ANGLE	LIFTING CAP. (LBS)	ANGLE	LIFTING CAP. (LBS)	ANGLE	LIFTING CAP. (LBS)	ANGLE	LIFTING CAP. (LBS)	ANGLE	LIFTING CAP. (LBS)	ANGLE	LIFTING CAP. (LBS)	ANGLE	LIFTING CAP. (LBS)	LOAD RADIUS (FT)
LENGTH	39.3 FT		53 FT		66 FT		79 FT		92 FT		105 FT		118 FT		131 FT		
6	74°	90000															6
8	70°	90000															8
10	67°	90000	74°	79200	77°	72400											10
12	64°	90000	71°	79200	76°	68300	78°	53900									12
15	59°	81800	68°	73500	73°	61800	76°	49100	79°	37600							15
20	50°	59700	62°	60600	68°	52500	72°	42600	75°	33100	78°	28700					20
25	40°	46100	55°	47100	63°	45500	69°	37100	72°	29100	75°	25500	77°	22500			25
30	26°	33100	49°	34600	58°	35400	65°	32900	69°	25700	72°	23100	75°	20500	77°	17900	30
35			41°	25300	53°	26000	61°	26500	66°	23200	69°	20700	73°	18600	75°	16600	35
40			31°	19300	47°	20000	56°	20400	62°	20700	66°	18700	70°	16900	73°	15200	40
45			18°	15000	41°	15800	52°	16200	58°	16500	63°	16700	67°	15300	70°	13900	45
50					35°	12600	47°	13000	55°	13300	60°	13600	65°	13700	68°	12700	50
55					28°	9900	41°	10400	51°	10700	57°	10900	62°	11100	66°	11200	55
60					18°	7800	35°	8400	46°	8700	54°	8900	59°	9100	63°	9200	60
65							28°	6800	42°	7100	50°	7300	56°	7400	61°	7600	65
70							18°	5400	36°	5800	46°	6000	53°	6100	58°	6200	70
75									30°	4700	42°	4900	50°	5000	55°	5100	75
80									23°	3700	38°	3900	46°	4100	52°	4200	80
85									11°	2900	33°	3100	43°	3300	49°	3400	85
90											27°	2400	39°	2600	46°	2700	90
95											19°	1800	34°	2000	43°	2100	95
100													29°	1500	39°	1600	100
105													23°	1000	36°	1100	105
110																	110
115																	115
120																	120
125																	125
130																	130
DEDUCTIONS FOR MAIN BOOM CAPACITIES	0°	27200	0°	13700	0°	7750	0°	5100	0°	2850	0°	1850	0°	0	0°	0	
		1570		1140		920		770		660		580		520		460	STOWED
		3510		3240		3100		3010		2940		2890		2850		2820	RET
		3910		3530		3340		3200		3110		3040		2980		2940	EXT
	2620		2420		2320		2250		2200		2170		2140		2120	FIXED	

# CODE 10

## MAIN BOOM



LOAD RADIUS (FT)	ANGLE	LIFTING CAP. (LBS)	ANGLE	LIFTING CAP. (LBS)	ANGLE	LIFTING CAP. (LBS)	ANGLE	LIFTING CAP. (LBS)	ANGLE	LIFTING CAP. (LBS)	ANGLE	LIFTING CAP. (LBS)	ANGLE	LIFTING CAP. (LBS)	ANGLE	LIFTING CAP. (LBS)	LOAD RADIUS (FT)
LENGTH	39.3 FT		53 FT		66 FT		79 FT		92 FT		105 FT		118 FT		131 FT		
6	74°	90000															6
8	70°	90000															8
10	67°	90000	74°	79200	77°	72400											10
12	64°	90000	71°	79200	76°	68300	78°	53900									12
15	59°	83200	68°	73500	73°	61800	76°	49100	79°	37600							15
20	50°	64800	62°	61700	68°	52500	72°	42600	75°	33100	78°	28700					20
25	40°	50300	55°	51200	63°	45500	69°	37100	72°	29100	75°	25500	77°	22500			25
30	26°	40400	49°	41400	58°	39800	65°	32900	69°	25700	72°	23100	75°	20500	77°	17900	30
35			41°	34300	53°	34800	61°	29300	66°	23200	69°	20700	73°	18600	75°	16600	35
40			31°	28900	47°	29500	56°	26100	62°	20700	66°	18700	70°	16900	73°	15200	40
45			18°	23800	41°	24500	52°	23700	58°	18700	63°	16900	67°	15300	70°	13900	45
50					35°	20500	47°	20900	55°	16900	60°	15300	65°	14000	68°	12700	50
55					28°	17400	41°	17800	51°	15400	57°	14000	62°	12800	66°	11900	55
60					18°	13800	35°	15300	46°	14000	54°	12700	59°	11900	63°	10900	60
65							28°	13200	42°	12800	50°	11900	56°	10900	61°	10000	65
70							18°	11500	36°	11800	46°	10900	53°	10000	58°	9200	70
75									30°	10300	42°	10000	50°	9200	55°	8500	75
80									23°	9000	38°	9200	46°	8500	52°	7800	80
85									11°	7900	33°	8200	43°	7800	49°	7200	85
90											27°	7200	39°	7200	46°	6600	90
95											19°	6300	34°	6500	43°	6100	95
100													29°	5800	39°	5600	100
105													23°	5100	36°	5100	105
110													14°	4500	31°	4600	110
115															26°	4000	115
120															19°	3500	120
125															6°	3100	125
130																	130
DEDUCTIONS FOR MAIN BOOM CAPACITIES	0°	30500	0°	19550	0°	13600	0°	9050	0°	7250	0°	4500	0°	3700	0°	600	
		1570		1140		920		770		660		580		520		460	STOWED
		3510		3240		3100		3010		2940		2890		2850		2820	RET
		3910		3530		3340		3200		3110		3040		2980		2940	EXT
	2620		2420		2320		2250		2200		2170		2140		2120	FIXED	

# CODE 11

## MAIN BOOM



**8,750**

**24'-6"**

**REAR**

LOAD RADIUS (FT)	ANGLE	LIFTING CAP. (LBS)	ANGLE	LIFTING CAP. (LBS)	ANGLE	LIFTING CAP. (LBS)	ANGLE	LIFTING CAP. (LBS)	ANGLE	LIFTING CAP. (LBS)	ANGLE	LIFTING CAP. (LBS)	ANGLE	LIFTING CAP. (LBS)	ANGLE	LIFTING CAP. (LBS)	LOAD RADIUS (FT)	
LENGTH	39.3 FT		53 FT		66 FT		79 FT		92 FT		105 FT		118 FT		131 FT			
6	74°	90000															6	
8	70°	90000															8	
10	67°	90000	74°	79200	77°	72400											10	
12	64°	90000	71°	79200	76°	68300	78°	53900									12	
15	59°	83200	68°	73500	73°	61800	76°	49100	79°	37600							15	
20	50°	64200	62°	61700	68°	52500	72°	42600	75°	33100	78°	28700					20	
25	40°	49700	55°	50700	63°	45500	69°	37100	72°	29100	75°	25500	77°	22500			25	
30	26°	39900	49°	41000	58°	39800	65°	32900	69°	25700	72°	23100	75°	20500	77°	17900	30	
35			41°	33900	53°	34400	61°	29300	66°	23200	69°	20700	73°	18600	75°	16600	35	
40			31°	28500	47°	29100	56°	26100	62°	20700	66°	18700	70°	16900	73°	15200	40	
45			18°	23200	41°	23900	52°	23700	58°	18700	63°	16900	67°	15300	70°	13900	45	
50					35°	20000	47°	20400	55°	16900	60°	15300	65°	14000	68°	12700	50	
55					28°	16900	41°	17300	51°	15400	57°	14000	62°	12800	66°	11900	55	
60					18°	13800	35°	14800	46°	14000	54°	12700	59°	11900	63°	10900	60	
65							28°	12800	42°	12800	50°	11900	56°	10900	61°	10000	65	
70							18°	11100	36°	11400	46°	10900	53°	10000	58°	9200	70	
75									30°	10000	42°	10000	50°	9200	55°	8500	75	
80									23°	8700	38°	8900	46°	8500	52°	7800	80	
85									11°	7600	33°	7900	43°	7800	49°	7200	85	
90											27°	6900	39°	7100	46°	6600	90	
95											19°	6100	34°	6200	43°	6100	95	
100													29°	5500	39°	5600	100	
105														23°	4900	36°	5000	105
110														14°	4200	31°	4400	110
115																26°	3800	115
120																19°	3300	120
125																6°	2900	125
130																		130
DEDUCTIONS FOR MAIN BOOM CAPACITIES	0°	30300	0°	19200	0°	13600	0°	8900	0°	7000	0°	4450	0°	3550	0°	600		
		1570		1140		920		770		660		580		520		460	STOWED	
		3510		3240		3100		3010		2940		2890		2850		2820	RET	
		3910		3530		3340		3200		3110		3040		2980		2940	EXT	
	2620		2420		2320		2250		2200		2170		2140		2120	FIXED		

# CODE 12

## MAIN BOOM

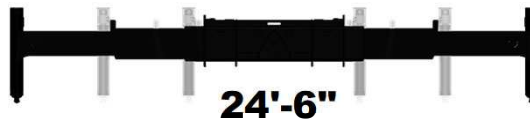

LOAD RADIUS (FT)	ANGLE	LIFTING CAP. (LBS)	ANGLE	LIFTING CAP. (LBS)	ANGLE	LIFTING CAP. (LBS)	ANGLE	LIFTING CAP. (LBS)	ANGLE	LIFTING CAP. (LBS)	ANGLE	LIFTING CAP. (LBS)	ANGLE	LIFTING CAP. (LBS)	ANGLE	LIFTING CAP. (LBS)	LOAD RADIUS (FT)
LENGTH	39.3 FT		53 FT		66 FT		79 FT		92 FT		105 FT		118 FT		131 FT		
6	74°	90000															6
8	70°	90000															8
10	67°	90000	74°	79200	77°	72400											10
12	64°	90000	71°	79200	76°	68300	78°	53900									12
15	59°	83200	68°	73500	73°	61800	76°	49100	79°	37600							15
20	50°	63500	62°	61700	68°	52500	72°	42600	75°	33100	78°	28700					20
25	40°	49200	55°	50200	63°	45500	69°	37100	72°	29100	75°	25500	77°	22500			25
30	26°	39500	49°	40500	58°	39800	65°	32900	69°	25700	72°	23100	75°	20500	77°	17900	30
35			41°	33500	53°	34100	61°	29300	66°	23200	69°	20700	73°	18600	75°	16600	35
40			31°	27700	47°	28400	56°	26100	62°	20700	66°	18700	70°	16900	73°	15200	40
45			18°	22600	41°	23300	52°	23700	58°	18700	63°	16900	67°	15300	70°	13900	45
50					35°	19400	47°	19800	55°	16900	60°	15300	65°	14000	68°	12700	50
55					28°	16400	41°	16800	51°	15400	57°	14000	62°	12800	66°	11900	55
60					18°	13800	35°	14400	46°	14000	54°	12700	59°	11900	63°	10900	60
65							28°	12400	42°	12700	50°	11900	56°	10900	61°	10000	65
70							18°	10700	36°	11000	46°	10900	53°	10000	58°	9200	70
75									30°	9600	42°	9800	50°	9200	55°	8500	75
80									23°	8400	38°	8600	46°	8500	52°	7800	80
85									11°	7300	33°	7600	43°	7700	49°	7200	85
90											27°	6600	39°	6800	46°	6600	90
95											19°	5800	34°	6000	43°	6100	95
100													29°	5300	39°	5400	100
105													23°	4600	36°	4700	105
110													14°	4000	31°	4100	110
115															26°	3600	115
120															19°	3100	120
125															6°	2700	125
130																	130
DEDUCTIONS FOR MAIN BOOM CAPACITIES	0°	30100	0°	18900	0°	13600	0°	8750	0°	6800	0°	4400	0°	3400	0°	600	
		1570		1140		920		770		660		580		520		460	STOWED
		3510		3240		3100		3010		2940		2890		2850		2820	RET
		3910		3530		3340		3200		3110		3040		2980		2940	EXT
	2620		2420		2320		2250		2200		2170		2140		2120	FIXED	

# CODE 13

## MAIN BOOM

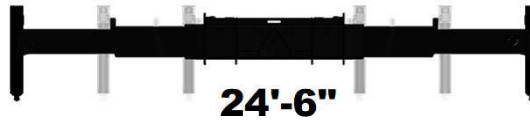

LOAD RADIUS (FT)	ANGLE	LIFTING CAP. (LBS)	ANGLE	LIFTING CAP. (LBS)	ANGLE	LIFTING CAP. (LBS)	ANGLE	LIFTING CAP. (LBS)	ANGLE	LIFTING CAP. (LBS)	ANGLE	LIFTING CAP. (LBS)	ANGLE	LIFTING CAP. (LBS)	ANGLE	LIFTING CAP. (LBS)	LOAD RADIUS (FT)
LENGTH	39.3 FT		53 FT		66 FT		79 FT		92 FT		105 FT		118 FT		131 FT		
6	74°	90000															6
8	70°	90000															8
10	67°	90000	74°	79200	77°	72400											10
12	64°	90000	71°	79200	76°	68300	78°	53900									12
15	59°	83200	68°	73500	73°	61800	76°	49100	79°	37600							15
20	50°	62900	62°	61700	68°	52500	72°	42600	75°	33100	78°	28700					20
25	40°	48700	55°	49700	63°	45500	69°	37100	72°	29100	75°	25500	77°	22500			25
30	26°	39000	49°	40100	58°	39800	65°	32900	69°	25700	72°	23100	75°	20500	77°	17900	30
35			41°	33200	53°	33700	61°	29300	66°	23200	69°	20700	73°	18600	75°	16600	35
40			31°	27000	47°	27600	56°	26100	62°	20700	66°	18700	70°	16900	73°	15200	40
45			18°	21900	41°	22600	52°	23000	58°	18700	63°	16900	67°	15300	70°	13900	45
50					35°	18800	47°	19200	55°	16900	60°	15300	65°	14000	68°	12700	50
55					28°	15900	41°	16300	51°	15400	57°	14000	62°	12800	66°	11900	55
60					18°	13400	35°	13900	46°	14000	54°	12700	59°	11900	63°	10900	60
65							28°	12000	42°	12300	50°	11900	56°	10900	61°	10000	65
70							18°	10300	36°	10600	46°	10800	53°	10000	58°	9200	70
75									30°	9300	42°	9500	50°	9200	55°	8500	75
80									23°	8100	38°	8300	46°	8400	52°	7800	80
85									11°	7000	33°	7300	43°	7400	49°	7200	85
90											27°	6400	39°	6500	46°	6600	90
95											19°	5600	34°	5700	43°	5800	95
100													29°	5000	39°	5100	100
105													23°	4400	36°	4500	105
110													14°	3800	31°	3900	110
115															26°	3400	115
120															19°	2900	120
125															6°	2500	125
130																	130
DEDUCTIONS FOR MAIN BOOM CAPACITIES	0°	29850	0°	18500	0°	13200	0°	8600	0°	6550	0°	4400	0°	3300	0°	600	
		1570		1140		920		770		660		580		520		460	STOWED
		3510		3240		3100		3010		2940		2890		2850		2820	RET
		3910		3530		3340		3200		3110		3040		2980		2940	EXT
	2620		2420		2320		2250		2200		2170		2140		2120	FIXED	

# CODE 14

## MAIN BOOM

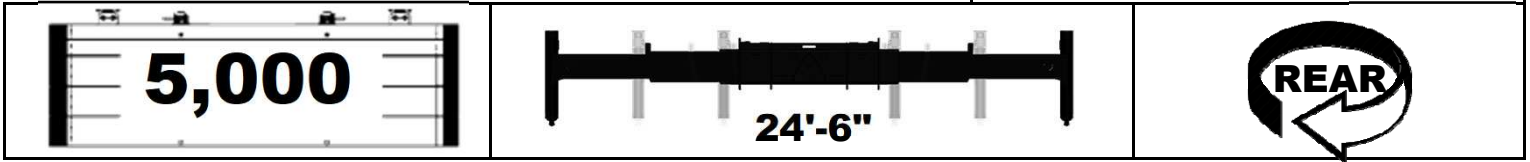

LOAD RADIUS (FT)	ANGLE	LIFTING CAP. (LBS)	ANGLE	LIFTING CAP. (LBS)	ANGLE	LIFTING CAP. (LBS)	ANGLE	LIFTING CAP. (LBS)	ANGLE	LIFTING CAP. (LBS)	ANGLE	LIFTING CAP. (LBS)	ANGLE	LIFTING CAP. (LBS)	ANGLE	LIFTING CAP. (LBS)	LOAD RADIUS (FT)
LENGTH	39.3 FT		53 FT		66 FT		79 FT		92 FT		105 FT		118 FT		131 FT		
6	74°	90000															6
8	70°	90000															8
10	67°	90000	74°	79200	77°	72400											10
12	64°	90000	71°	79200	76°	68300	78°	53900									12
15	59°	83200	68°	73500	73°	61800	76°	49100	79°	37600							15
20	50°	62300	62°	61700	68°	52500	72°	42600	75°	33100	78°	28700					20
25	40°	48200	55°	49200	63°	45500	69°	37100	72°	29100	75°	25500	77°	22500			25
30	26°	38600	49°	39600	58°	39800	65°	32900	69°	25700	72°	23100	75°	20500	77°	17900	30
35			41°	32800	53°	33300	61°	29300	66°	23200	69°	20700	73°	18600	75°	16600	35
40			31°	26200	47°	26900	56°	26100	62°	20700	66°	18700	70°	16900	73°	15200	40
45			18°	21300	41°	22000	52°	22400	58°	18700	63°	16900	67°	15300	70°	13900	45
50					35°	18300	47°	18700	55°	16900	60°	15300	65°	14000	68°	12700	50
55					28°	15400	41°	15800	51°	15400	57°	14000	62°	12800	66°	11900	55
60					18°	13000	35°	13500	46°	13700	54°	12700	59°	11900	63°	10900	60
65							28°	11600	42°	11800	50°	11900	56°	10900	61°	10000	65
70							18°	10000	36°	10300	46°	10500	53°	10000	58°	9200	70
75									30°	8900	42°	9100	50°	9200	55°	8500	75
80									23°	7800	38°	8000	46°	8100	52°	7800	80
85									11°	6700	33°	7000	43°	7100	49°	7200	85
90											27°	6100	39°	6200	46°	6300	90
95											19°	5300	34°	5500	43°	5600	95
100													29°	4800	39°	4900	100
105													23°	4100	36°	4300	105
110													14°	3600	31°	3700	110
115															26°	3200	115
120															19°	2700	120
125															6°	2300	125
130																	130
DEDUCTIONS FOR MAIN BOOM CAPACITIES	0°	29700	0°	18150	0°	12800	0°	8500	0°	6350	0°	4350	0°	3200	0°	600	
		1570		1140		920		770		660		580		520		460	STOWED
		3510		3240		3100		3010		2940		2890		2850		2820	RET
		3910		3530		3340		3200		3110		3040		2980		2940	EXT
	2620		2420		2320		2250		2200		2170		2140		2120	FIXED	



# CODE 15

## MAIN BOOM



**3,750**

**24'-6"**

**REAR**

LOAD RADIUS (FT)	ANGLE	LIFTING CAP. (LBS)	ANGLE	LIFTING CAP. (LBS)	ANGLE	LIFTING CAP. (LBS)	ANGLE	LIFTING CAP. (LBS)	ANGLE	LIFTING CAP. (LBS)	ANGLE	LIFTING CAP. (LBS)	ANGLE	LIFTING CAP. (LBS)	ANGLE	LIFTING CAP. (LBS)	LOAD RADIUS (FT)
<b>LENGTH</b>		<b>39.3 FT</b>		<b>53 FT</b>		<b>66 FT</b>		<b>79 FT</b>		<b>92 FT</b>		<b>105 FT</b>		<b>118 FT</b>		<b>131 FT</b>	
6	74°	90000															6
8	70°	90000															8
10	67°	90000	74°	79200	77°	72400											10
12	64°	90000	71°	79200	76°	68300	78°	53900									12
15	59°	83200	68°	73500	73°	61800	76°	49100	79°	37600							15
20	50°	61600	62°	61700	68°	52500	72°	42600	75°	33100	78°	28700					20
25	40°	47700	55°	48600	63°	45500	69°	37100	72°	29100	75°	25500	77°	22500			25
30	26°	38200	49°	39200	58°	39700	65°	32900	69°	25700	72°	23100	75°	20500	77°	17900	30
35			41°	32200	53°	32900	61°	29300	66°	23200	69°	20700	73°	18600	75°	16600	35
40			31°	25500	47°	26200	56°	26100	62°	20700	66°	18700	70°	16900	73°	15200	40
45			18°	20700	41°	21300	52°	21700	58°	18700	63°	16900	67°	15300	70°	13900	45
50					35°	17700	47°	18100	55°	16900	60°	15300	65°	14000	68°	12700	50
55					28°	14900	41°	15300	51°	15400	57°	14000	62°	12800	66°	11900	55
60					18°	12500	35°	13000	46°	13300	54°	12700	59°	11900	63°	10900	60
65							28°	11200	42°	11400	50°	11600	56°	10900	61°	10000	65
70							18°	9600	36°	9900	46°	10100	53°	10000	58°	9200	70
75									30°	8600	42°	8800	50°	8900	55°	8500	75
80									23°	7400	38°	7600	46°	7800	52°	7800	80
85									11°	6400	33°	6700	43°	6800	49°	6900	85
90											27°	5800	39°	5900	46°	6000	90
95											19°	5000	34°	5200	43°	5300	95
100													29°	4500	39°	4600	100
105													23°	3900	36°	4000	105
110													14°	3300	31°	3500	110
115															26°	3000	115
120															19°	2500	120
125															6°	2100	125
130																	130
DEDUCTIONS FOR MAIN BOOM CAPACITIES	0°	29500	0°	17850	0°	12350	0°	8350	0°	6100	0°	4300	0°	3050	0°	600	
		1570		1140		920		770		660		580		520		460	STOWED
		3510		3240		3100		3010		2940		2890		2850		2820	RET
		3910		3530		3340		3200		3110		3040		2980		2940	EXT
	2620		2420		2320		2250		2200		2170		2140		2120	FIXED	

# CODE 16

## MAIN BOOM

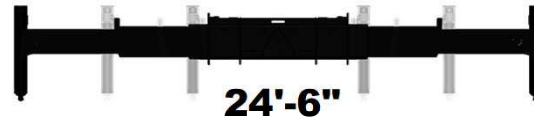

LOAD RADIUS (FT)	ANGLE	LIFTING CAP. (LBS)	ANGLE	LIFTING CAP. (LBS)	ANGLE	LIFTING CAP. (LBS)	ANGLE	LIFTING CAP. (LBS)	ANGLE	LIFTING CAP. (LBS)	ANGLE	LIFTING CAP. (LBS)	ANGLE	LIFTING CAP. (LBS)	ANGLE	LIFTING CAP. (LBS)	LOAD RADIUS (FT)
LENGTH	39.3 FT		53 FT		66 FT		79 FT		92 FT		105 FT		118 FT		131 FT		
6	74°	90000															6
8	70°	90000															8
10	67°	90000	74°	79200	77°	72400											10
12	64°	90000	71°	79200	76°	68300	78°	53900									12
15	59°	83200	68°	73500	73°	61800	76°	49100	79°	37600							15
20	50°	61000	62°	61700	68°	52500	72°	42600	75°	33100	78°	28700					20
25	40°	47100	55°	48100	63°	45500	69°	37100	72°	29100	75°	25500	77°	22500			25
30	26°	37700	49°	38800	58°	39300	65°	32900	69°	25700	72°	23100	75°	20500	77°	17900	30
35			41°	31300	53°	32000	61°	29300	66°	23200	69°	20700	73°	18600	75°	16600	35
40			31°	24800	47°	25400	56°	25800	62°	20700	66°	18700	70°	16900	73°	15200	40
45			18°	20000	41°	20700	52°	21100	58°	18700	63°	16900	67°	15300	70°	13900	45
50					35°	17200	47°	17600	55°	16900	60°	15300	65°	14000	68°	12700	50
55					28°	14400	41°	14800	51°	15100	57°	14000	62°	12800	66°	11900	55
60					18°	12100	35°	12600	46°	12800	54°	12700	59°	11900	63°	10900	60
65							28°	10800	42°	11000	50°	11200	56°	10900	61°	10000	65
70							18°	9200	36°	9500	46°	9700	53°	9800	58°	9200	70
75									30°	8200	42°	8400	50°	8600	55°	8500	75
80									23°	7100	38°	7300	46°	7500	52°	7600	80
85									11°	6100	33°	6400	43°	6500	49°	6600	85
90											27°	5500	39°	5700	46°	5800	90
95											19°	4800	34°	4900	43°	5000	95
100													29°	4300	39°	4400	100
105													23°	3700	36°	3800	105
110													14°	3100	31°	3300	110
115															26°	2800	115
120															19°	2300	120
125															6°	1900	125
130																	130
DEDUCTIONS FOR MAIN BOOM CAPACITIES	0°	29300	0°	17450	0°	11950	0°	8250	0°	5900	0°	4250	0°	2900	0°	600	
		1570		1140		920		770		660		580		520		460	STOWED
		3510		3240		3100		3010		2940		2890		2850		2820	RET
		3910		3530		3340		3200		3110		3040		2980		2940	EXT
	2620		2420		2320		2250		2200		2170		2140		2120	FIXED	

# CODE 17

## MAIN BOOM



1,250

24'-6"

REAR

LOAD RADIUS (FT)	ANGLE	LIFTING CAP. (LBS)	ANGLE	LIFTING CAP. (LBS)	ANGLE	LIFTING CAP. (LBS)	ANGLE	LIFTING CAP. (LBS)	ANGLE	LIFTING CAP. (LBS)	ANGLE	LIFTING CAP. (LBS)	ANGLE	LIFTING CAP. (LBS)	ANGLE	LIFTING CAP. (LBS)	LOAD RADIUS (FT)
LENGTH	39.3 FT		53 FT		66 FT		79 FT		92 FT		105 FT		118 FT		131 FT		
6	74°	90000															6
8	70°	90000															8
10	67°	90000	74°	79200	77°	72400											10
12	64°	90000	71°	79200	76°	68300	78°	53900									12
15	59°	82700	68°	73500	73°	61800	76°	49100	79°	37600							15
20	50°	60300	62°	61300	68°	52500	72°	42600	75°	33100	78°	28700					20
25	40°	46600	55°	47600	63°	45500	69°	37100	72°	29100	75°	25500	77°	22500			25
30	26°	37300	49°	38300	58°	38900	65°	32900	69°	25700	72°	23100	75°	20500	77°	17900	30
35			41°	30400	53°	31100	61°	29300	66°	23200	69°	20700	73°	18600	75°	16600	35
40			31°	24000	47°	24700	56°	25100	62°	20700	66°	18700	70°	16900	73°	15200	40
45			18°	19400	41°	20100	52°	20500	58°	18700	63°	16900	67°	15300	70°	13900	45
50					35°	16600	47°	17000	55°	16900	60°	15300	65°	14000	68°	12700	50
55					28°	13900	41°	14300	51°	14600	57°	14000	62°	12800	66°	11900	55
60					18°	11700	35°	12100	46°	12400	54°	12600	59°	11900	63°	10900	60
65							28°	10400	42°	10600	50°	10800	56°	10900	61°	10000	65
70							18°	8900	36°	9100	46°	9300	53°	9500	58°	9200	70
75									30°	7900	42°	8100	50°	8200	55°	8300	75
80									23°	6800	38°	7000	46°	7100	52°	7200	80
85									11°	5800	33°	6100	43°	6200	49°	6300	85
90											27°	5200	39°	5400	46°	5500	90
95											19°	4500	34°	4700	43°	4800	95
100													29°	4000	39°	4100	100
105													23°	3400	36°	3600	105
110													14°	2900	31°	3000	110
115															26°	2600	115
120															19°	2100	120
125															6°	1700	125
130																	130
DEDUCTIONS FOR MAIN BOOM CAPACITIES	0°	29100	0°	17150	0°	11600	0°	8100	0°	5600	0°	3950	0°	2700	0°	400	
		1570		1140		920		770		660		580		520		460	STOWED
		3510		3240		3100		3010		2940		2890		2850		2820	RET
		3910		3530		3340		3200		3110		3040		2980		2940	EXT
	2620		2420		2320		2250		2200		2170		2140		2120	FIXED	

# CODE 18

## MAIN BOOM

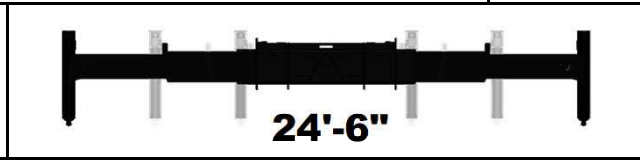
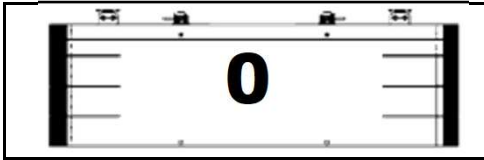

LOAD RADIUS (FT)	ANGLE	LIFTING CAP. (LBS)	ANGLE	LIFTING CAP. (LBS)	ANGLE	LIFTING CAP. (LBS)	ANGLE	LIFTING CAP. (LBS)	ANGLE	LIFTING CAP. (LBS)	ANGLE	LIFTING CAP. (LBS)	ANGLE	LIFTING CAP. (LBS)	ANGLE	LIFTING CAP. (LBS)	LOAD RADIUS (FT)
LENGTH	39.3 FT		53 FT		66 FT		79 FT		92 FT		105 FT		118 FT		131 FT		
6	74°	90000															6
8	70°	90000															8
10	67°	90000	74°	79200	77°	72400											10
12	64°	90000	71°	79200	76°	68300	78°	53900									12
15	59°	81800	68°	73500	73°	61800	76°	49100	79°	37600							15
20	50°	59700	62°	60600	68°	52500	72°	42600	75°	33100	78°	28700					20
25	40°	46100	55°	47100	63°	45500	69°	37100	72°	29100	75°	25500	77°	22500			25
30	26°	36900	49°	37900	58°	38400	65°	32900	69°	25700	72°	23100	75°	20500	77°	17900	30
35			41°	29500	53°	30200	61°	29300	66°	23200	69°	20700	73°	18600	75°	16600	35
40			31°	23300	47°	23900	56°	24300	62°	20700	66°	18700	70°	16900	73°	15200	40
45			18°	18700	41°	19400	52°	19800	58°	18700	63°	16900	67°	15300	70°	13900	45
50					35°	16000	47°	16400	55°	16700	60°	15300	65°	14000	68°	12700	50
55					28°	13400	41°	13800	51°	14100	57°	14000	62°	12800	66°	11900	55
60					18°	11200	35°	11700	46°	11900	54°	12100	59°	11900	63°	10900	60
65							28°	9900	42°	10200	50°	10400	56°	10500	61°	10000	65
70							18°	8500	36°	8800	46°	9000	53°	9100	58°	9200	70
75									30°	7500	42°	7700	50°	7900	55°	8000	75
80									23°	6500	38°	6700	46°	6800	52°	6900	80
85									11°	5500	33°	5800	43°	5900	49°	6000	85
90											27°	5000	39°	5100	46°	5200	90
95											19°	4200	34°	4400	43°	4500	95
100													29°	3800	39°	3900	100
105													23°	3200	36°	3300	105
110													14°	2700	31°	2800	110
115															26°	2300	115
120															19°	1900	120
125															6°	1500	125
130																	130
DEDUCTIONS FOR MAIN BOOM CAPACITIES	0°	28950	0°	16750	0°	11100	0°	7750	0°	5300	0°	3700	0°	2500	0°	400	
		1570		1140		920		770		660		580		520		460	STOWED
		3510		3240		3100		3010		2940		2890		2850		2820	RET
		3910		3530		3340		3200		3110		3040		2980		2940	EXT
	2620		2420		2320		2250		2200		2170		2140		2120	FIXED	

# CODE 19

## MAIN BOOM



LOAD RADIUS (FT)	ANGLE	LIFTING CAP. (LBS)	ANGLE	LIFTING CAP. (LBS)	ANGLE	LIFTING CAP. (LBS)	ANGLE	LIFTING CAP. (LBS)	ANGLE	LIFTING CAP. (LBS)	ANGLE	LIFTING CAP. (LBS)	ANGLE	LIFTING CAP. (LBS)	ANGLE	LIFTING CAP. (LBS)	LOAD RADIUS (FT)
LENGTH	39.3 FT		53 FT		66 FT		79 FT		92 FT		105 FT		118 FT		131 FT		
6	74°	90000															6
8	70°	90000															8
10	67°	90000	74°	79200	77°	72400											10
12	64°	90000	71°	79200	76°	68300	78°	53900									12
15	59°	83200	68°	73500	73°	61800	76°	49100	79°	37600							15
20	50°	64800	62°	61700	68°	52500	72°	42600	75°	33100	78°	28700					20
25	40°	42200	55°	43600	63°	44400	69°	37100	72°	29100	75°	25500	77°	22500			25
30	26°	29300	49°	30700	58°	31400	65°	31800	69°	25700	72°	23100	75°	20500	77°	17900	30
35			41°	22900	53°	23500	61°	23900	66°	23200	69°	20700	73°	18600	75°	16600	35
40			31°	17700	47°	18300	56°	18700	62°	19000	66°	18700	70°	16900	73°	15200	40
45			18°	13900	41°	14600	52°	15000	58°	15200	63°	15400	67°	15300	70°	13900	45
50					35°	11800	47°	12100	55°	12400	60°	12600	65°	12700	68°	12700	50
55					28°	9600	41°	10000	51°	10200	57°	10400	62°	10500	66°	10600	55
60					18°	7700	35°	8200	46°	8500	54°	8600	59°	8800	63°	8900	60
65							28°	6800	42°	7000	50°	7200	56°	7300	61°	7400	65
70							18°	5500	36°	5800	46°	6000	53°	6100	58°	6200	70
75									30°	4800	42°	5000	50°	5100	55°	5200	75
80									23°	3900	38°	4100	46°	4200	52°	4300	80
85									11°	3100	33°	3300	43°	3500	49°	3600	85
90											27°	2700	39°	2800	46°	2900	90
95											19°	2100	34°	2200	43°	2300	95
100													29°	1700	39°	1800	100
105													23°	1200	36°	1300	105
110													14°	800	31°	900	110
115																	115
120																	120
125																	125
130																	130
DEDUCTIONS FOR MAIN BOOM CAPACITIES	0°	25150	0°	12700	0°	7600	0°	4850	0°	2950	0°	1600	0°	600	0°	600	
		1570		1140		920		770		660		580		520		460	STOWED
		3510		3240		3100		3010		2940		2890		2850		2820	RET
		3910		3530		3340		3200		3110		3040		2980		2940	EXT
	2620		2420		2320		2250		2200		2170		2140		2120	FIXED	

# CODE 20

## MAIN BOOM



**8,750**

**20'-0"**

**360°**

LOAD RADIUS (FT)	ANGLE	LIFTING CAP. (LBS)	ANGLE	LIFTING CAP. (LBS)	ANGLE	LIFTING CAP. (LBS)	ANGLE	LIFTING CAP. (LBS)	ANGLE	LIFTING CAP. (LBS)	ANGLE	LIFTING CAP. (LBS)	ANGLE	LIFTING CAP. (LBS)	ANGLE	LIFTING CAP. (LBS)	LOAD RADIUS (FT)
<b>LENGTH</b>		<b>39.3 FT</b>	<b>53 FT</b>		<b>66 FT</b>		<b>79 FT</b>		<b>92 FT</b>		<b>105 FT</b>		<b>118 FT</b>		<b>131 FT</b>		
6	74°	90000															6
8	70°	90000															8
10	67°	90000	74°	79200	77°	72400											10
12	64°	90000	71°	79200	76°	68300	78°	53900									12
15	59°	83200	68°	73500	73°	61800	76°	49100	79°	37600							15
20	50°	64200	62°	61700	68°	52500	72°	42600	75°	33100	78°	28700					20
25	40°	40800	55°	42200	63°	43000	69°	37100	72°	29100	75°	25500	77°	22500			25
30	26°	28200	49°	29600	58°	30300	65°	30700	69°	25700	72°	23100	75°	20500	77°	17900	30
35			41°	22000	53°	22700	61°	23100	66°	23200	69°	20700	73°	18600	75°	16600	35
40			31°	16900	47°	17600	56°	18000	62°	18300	66°	18500	70°	16900	73°	15200	40
45			18°	13300	41°	14000	52°	14400	58°	14600	63°	14800	67°	15000	70°	13900	45
50					35°	11200	47°	11600	55°	11900	60°	12100	65°	12200	68°	12300	50
55					28°	9100	41°	9500	51°	9700	57°	9900	62°	10100	66°	10200	55
60					18°	7300	35°	7800	46°	8000	54°	8200	59°	8300	63°	8500	60
65							28°	6400	42°	6600	50°	6800	56°	6900	61°	7000	65
70							18°	5200	36°	5500	46°	5600	53°	5800	58°	5900	70
75									30°	4500	42°	4700	50°	4800	55°	4900	75
80									23°	3600	38°	3800	46°	3900	52°	4000	80
85									11°	2800	33°	3000	43°	3200	49°	3300	85
90											27°	2400	39°	2500	46°	2600	90
95											19°	1800	34°	2000	43°	2100	95
100													29°	1500	39°	1600	100
105													23°	1000	36°	1100	105
110																	110
115																	115
120																	120
125																	125
130																	130
DEDUCTIONS FOR MAIN BOOM CAPACITIES	0°	24150	0°	12150	0°	7200	0°	4550	0°	2650	0°	1400	0°	350	0°	0	
		1570		1140		920		770		660		580		520		460	STOWED
		3510		3240		3100		3010		2940		2890		2850		2820	RET
		3910		3530		3340		3200		3110		3040		2980		2940	EXT
	2620		2420		2320		2250		2200		2170		2140		2120	FIXED	

# CODE 21

## MAIN BOOM

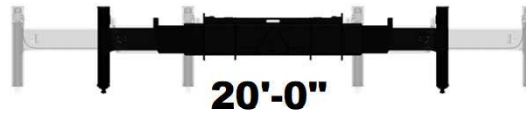

LOAD RADIUS (FT)	ANGLE	LIFTING CAP. (LBS)	ANGLE	LIFTING CAP. (LBS)	ANGLE	LIFTING CAP. (LBS)	ANGLE	LIFTING CAP. (LBS)	ANGLE	LIFTING CAP. (LBS)	ANGLE	LIFTING CAP. (LBS)	ANGLE	LIFTING CAP. (LBS)	ANGLE	LIFTING CAP. (LBS)	LOAD RADIUS (FT)
LENGTH	39.3 FT		53 FT		66 FT		79 FT		92 FT		105 FT		118 FT		131 FT		
6	74°	90000															6
8	70°	90000															8
10	67°	90000	74°	79200	77°	72400											10
12	64°	90000	71°	79200	76°	68300	78°	53900									12
15	59°	83200	68°	73500	73°	61800	76°	49100	79°	37600							15
20	50°	63500	62°	61700	68°	52500	72°	42600	75°	33100	78°	28700					20
25	40°	39300	55°	40800	63°	41500	69°	37100	72°	29100	75°	25500	77°	22500			25
30	26°	27200	49°	28500	58°	29200	65°	29700	69°	25700	72°	23100	75°	20500	77°	17900	30
35			41°	21200	53°	21800	61°	22200	66°	22500	69°	20700	73°	18600	75°	16600	35
40			31°	16200	47°	16900	56°	17300	62°	17600	66°	17800	70°	16900	73°	15200	40
45			18°	12700	41°	13400	52°	13700	58°	14000	63°	14200	67°	14300	70°	13900	45
50					35°	10700	47°	11100	55°	11300	60°	11500	65°	11700	68°	11800	50
55					28°	8600	41°	9000	51°	9300	57°	9500	62°	9600	66°	9700	55
60					18°	6900	35°	7300	46°	7600	54°	7800	59°	7900	63°	8000	60
65							28°	6000	42°	6200	50°	6400	56°	6600	61°	6700	65
70							18°	4800	36°	5100	46°	5300	53°	5400	58°	5500	70
75									30°	4100	42°	4300	50°	4500	55°	4600	75
80									23°	3300	38°	3500	46°	3600	52°	3700	80
85									11°	2500	33°	2800	43°	2900	49°	3000	85
90											27°	2100	39°	2300	46°	2400	90
95											19°	1600	34°	1700	43°	1800	95
100													29°	1200	39°	1300	100
105													23°	800	36°	900	105
110																	110
115																	115
120																	120
125																	125
130																	130
DEDUCTIONS FOR MAIN BOOM CAPACITIES	0°	23250	0°	11550	0°	6800	0°	4200	0°	2350	0°	1150	0°	100	0°	0	
		1570		1140		920		770		660		580		520		460	STOWED
		3510		3240		3100		3010		2940		2890		2850		2820	RET
		3910		3530		3340		3200		3110		3040		2980		2940	EXT
	2620		2420		2320		2250		2200		2170		2140		2120	FIXED	

# CODE 22

## MAIN BOOM



**6,250**

**20'-0"**

**360°**

LOAD RADIUS (FT)	ANGLE	LIFTING CAP. (LBS)	ANGLE	LIFTING CAP. (LBS)	ANGLE	LIFTING CAP. (LBS)	ANGLE	LIFTING CAP. (LBS)	ANGLE	LIFTING CAP. (LBS)	ANGLE	LIFTING CAP. (LBS)	ANGLE	LIFTING CAP. (LBS)	ANGLE	LIFTING CAP. (LBS)	LOAD RADIUS (FT)
<b>LENGTH</b>		<b>39.3 FT</b>	<b>53 FT</b>		<b>66 FT</b>		<b>79 FT</b>		<b>92 FT</b>		<b>105 FT</b>		<b>118 FT</b>		<b>131 FT</b>		
6	74°	90000															6
8	70°	90000															8
10	67°	90000	74°	79200	77°	72400											10
12	64°	90000	71°	79200	76°	68300	78°	53900									12
15	59°	83200	68°	73500	73°	61800	76°	49100	79°	37600							15
20	50°	61400	62°	61700	68°	52500	72°	42600	75°	33100	78°	28700					20
25	40°	37900	55°	39300	63°	40100	69°	37100	72°	29100	75°	25500	77°	22500			25
30	26°	26100	49°	27500	58°	28100	65°	28600	69°	25700	72°	23100	75°	20500	77°	17900	30
35			41°	20300	53°	21000	61°	21400	66°	21700	69°	20700	73°	18600	75°	16600	35
40			31°	15500	47°	16200	56°	16600	62°	16800	66°	17000	70°	16900	73°	15200	40
45			18°	12100	41°	12700	52°	13100	58°	13400	63°	13600	67°	13700	70°	13800	45
50					35°	10200	47°	10500	55°	10800	60°	11000	65°	11100	68°	11200	50
55					28°	8100	41°	8500	51°	8800	57°	9000	62°	9100	66°	9200	55
60					18°	6400	35°	6900	46°	7200	54°	7400	59°	7500	63°	7600	60
65							28°	5600	42°	5900	50°	6000	56°	6200	61°	6300	65
70							18°	4500	36°	4700	46°	4900	53°	5100	58°	5200	70
75									30°	3800	42°	4000	50°	4100	55°	4200	75
80									23°	3000	38°	3200	46°	3300	52°	3400	80
85									11°	2300	33°	2500	43°	2600	49°	2700	85
90											27°	1900	39°	2000	46°	2100	90
95											19°	1300	34°	1500	43°	1600	95
100													29°	1000	39°	1100	100
105																	105
110																	110
115																	115
120																	120
125																	125
130																	130
DEDUCTIONS FOR MAIN BOOM CAPACITIES	0°	22250	0°	11000	0°	6300	0°	3850	0°	2150	0°	900	0°	0	0°	0	
		1570		1140		920		770		660		580		520		460	STOWED
		3510		3240		3100		3010		2940		2890		2850		2820	RET
		3910		3530		3340		3200		3110		3040		2980		2940	EXT
	2620		2420		2320		2250		2200		2170		2140		2120	FIXED	



# CODE 23

## MAIN BOOM

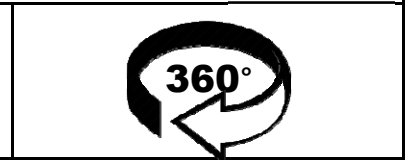

LOAD RADIUS (FT)	ANGLE	LIFTING CAP. (LBS)	ANGLE	LIFTING CAP. (LBS)	ANGLE	LIFTING CAP. (LBS)	ANGLE	LIFTING CAP. (LBS)	ANGLE	LIFTING CAP. (LBS)	ANGLE	LIFTING CAP. (LBS)	ANGLE	LIFTING CAP. (LBS)	ANGLE	LIFTING CAP. (LBS)	LOAD RADIUS (FT)
LENGTH	39.3 FT		53 FT		66 FT		79 FT		92 FT		105 FT		118 FT		131 FT		
6	74°	90000															6
8	70°	90000															8
10	67°	90000	74°	79200	77°	72400											10
12	64°	90000	71°	79200	76°	68300	78°	53900									12
15	59°	83200	68°	73500	73°	61800	76°	49100	79°	37600							15
20	50°	59300	62°	61000	68°	52500	72°	42600	75°	33100	78°	28700					20
25	40°	36500	55°	37900	63°	38700	69°	37100	72°	29100	75°	25500	77°	22500			25
30	26°	25000	49°	26400	58°	27100	65°	27500	69°	25700	72°	23100	75°	20500	77°	17900	30
35			41°	19500	53°	20100	61°	20500	66°	20800	69°	20700	73°	18600	75°	16600	35
40			31°	14800	47°	15500	56°	15900	62°	16100	66°	16300	70°	16500	73°	15200	40
45			18°	11400	41°	12100	52°	12500	58°	12800	63°	13000	67°	13100	70°	13200	45
50					35°	9600	47°	10000	55°	10300	60°	10500	65°	10600	68°	10700	50
55					28°	7700	41°	8100	51°	8300	57°	8500	62°	8600	66°	8700	55
60					18°	6000	35°	6500	46°	6800	54°	6900	59°	7100	63°	7200	60
65							28°	5200	42°	5500	50°	5600	56°	5800	61°	5900	65
70							18°	4100	36°	4400	46°	4600	53°	4700	58°	4800	70
75									30°	3500	42°	3700	50°	3800	55°	3900	75
80									23°	2700	38°	2900	46°	3000	52°	3100	80
85									11°	2000	33°	2200	43°	2300	49°	2400	85
90											27°	1600	39°	1700	46°	1800	90
95											19°	1100	34°	1200	43°	1300	95
100													29°	700	39°	900	100
105																	105
110																	110
115																	115
120																	120
125																	125
130																	130
DEDUCTIONS FOR MAIN BOOM CAPACITIES	0°	21300	0°	10350	0°	5900	0°	3500	0°	1850	0°	650	0°	0	0°	0	
		1570		1140		920		770		660		580		520		460	STOWED
		3510		3240		3100		3010		2940		2890		2850		2820	RET
		3910		3530		3340		3200		3110		3040		2980		2940	EXT
	2620		2420		2320		2250		2200		2170		2140		2120	FIXED	

# CODE 24

## MAIN BOOM

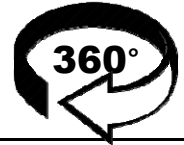
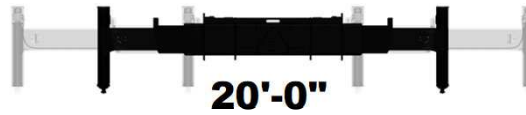

LOAD RADIUS (FT)	ANGLE	LIFTING CAP. (LBS)	ANGLE	LIFTING CAP. (LBS)	ANGLE	LIFTING CAP. (LBS)	ANGLE	LIFTING CAP. (LBS)	ANGLE	LIFTING CAP. (LBS)	ANGLE	LIFTING CAP. (LBS)	ANGLE	LIFTING CAP. (LBS)	ANGLE	LIFTING CAP. (LBS)	LOAD RADIUS (FT)
LENGTH	39.3 FT		53 FT		66 FT		79 FT		92 FT		105 FT		118 FT		131 FT		
6	74°	90000															6
8	70°	90000															8
10	67°	90000	74°	79200	77°	72400											10
12	64°	90000	71°	79200	76°	68300	78°	53900									12
15	59°	83200	68°	73500	73°	61800	76°	49100	79°	37600							15
20	50°	57100	62°	58800	68°	52500	72°	42600	75°	33100	78°	28700					20
25	40°	35000	55°	36500	63°	37300	69°	37100	72°	29100	75°	25500	77°	22500			25
30	26°	23900	49°	25300	58°	26000	65°	26500	69°	25700	72°	23100	75°	20500	77°	17900	30
35			41°	18600	53°	19300	61°	19700	66°	20000	69°	20200	73°	18600	75°	16600	35
40			31°	14100	47°	14700	56°	15100	62°	15400	66°	15600	70°	15800	73°	15200	40
45			18°	10800	41°	11500	52°	11900	58°	12200	63°	12400	67°	12500	70°	12600	45
50					35°	9100	47°	9500	55°	9700	60°	9900	65°	10100	68°	10200	50
55					28°	7200	41°	7600	51°	7800	57°	8000	62°	8200	66°	8300	55
60					18°	5600	35°	6100	46°	6300	54°	6500	59°	6600	63°	6700	60
65							28°	4800	42°	5100	50°	5300	56°	5400	61°	5500	65
70							18°	3700	36°	4000	46°	4200	53°	4300	58°	4500	70
75									30°	3100	42°	3300	50°	3500	55°	3600	75
80									23°	2400	38°	2600	46°	2700	52°	2800	80
85									11°	1700	33°	1900	43°	2000	49°	2200	85
90											27°	1300	39°	1500	46°	1600	90
95											19°	800	34°	1000	43°	1100	95
100																	100
105																	105
110																	110
115																	115
120																	120
125																	125
130																	130
DEDUCTIONS FOR MAIN BOOM CAPACITIES	0°	20350	0°	9800	0°	5500	0°	3150	0°	1550	0°	400	0°	0	0°	0	
		1570		1140		920		770		660		580		520		460	STOWED
		3510		3240		3100		3010		2940		2890		2850		2820	RET
		3910		3530		3340		3200		3110		3040		2980		2940	EXT
	2620		2420		2320		2250		2200		2170		2140		2120	FIXED	

# CODE 25

## MAIN BOOM



LOAD RADIUS (FT)	ANGLE	LIFTING CAP. (LBS)	ANGLE	LIFTING CAP. (LBS)	ANGLE	LIFTING CAP. (LBS)	ANGLE	LIFTING CAP. (LBS)	ANGLE	LIFTING CAP. (LBS)	ANGLE	LIFTING CAP. (LBS)	ANGLE	LIFTING CAP. (LBS)	ANGLE	LIFTING CAP. (LBS)	LOAD RADIUS (FT)
LENGTH	39.3 FT		53 FT		66 FT		79 FT		92 FT		105 FT		118 FT		131 FT		
6	74°	90000															6
8	70°	90000															8
10	67°	90000	74°	79200	77°	72400											10
12	64°	90000	71°	79200	76°	68300	78°	53900									12
15	59°	83200	68°	73500	73°	61800	76°	49100	79°	37600							15
20	50°	55000	62°	56700	68°	52500	72°	42600	75°	33100	78°	28700					20
25	40°	33600	55°	35100	63°	35800	69°	36300	72°	29100	75°	25500	77°	22500			25
30	26°	22900	49°	24200	58°	24900	65°	25400	69°	25700	72°	23100	75°	20500	77°	17900	30
35			41°	17700	53°	18400	61°	18800	66°	19100	69°	19300	73°	18600	75°	16600	35
40			31°	13400	47°	14000	56°	14400	62°	14700	66°	14900	70°	15100	73°	15200	40
45			18°	10200	41°	10900	52°	11300	58°	11600	63°	11800	67°	11900	70°	12000	45
50					35°	8600	47°	8900	55°	9200	60°	9400	65°	9500	68°	9600	50
55					28°	6700	41°	7100	51°	7400	57°	7600	62°	7700	66°	7800	55
60					18°	5100	35°	5600	46°	5900	54°	6100	59°	6200	63°	6300	60
65							28°	4400	42°	4700	50°	4900	56°	5000	61°	5100	65
70							18°	3400	36°	3700	46°	3900	53°	4000	58°	4100	70
75									30°	2800	42°	3000	50°	3100	55°	3200	75
80									23°	2100	38°	2300	46°	2400	52°	2500	80
85									11°	1400	33°	1600	43°	1800	49°	1900	85
90											27°	1100	39°	1200	46°	1300	90
95													34°	700	43°	800	95
100																	100
105																	105
110																	110
115																	115
120																	120
125																	125
130																	130
DEDUCTIONS FOR MAIN BOOM CAPACITIES	0°	19400	0°	9200	0°	5050	0°	2850	0°	1250	0°	0	0°	0	0°	0	
		1570		1140		920		770		660		580		520		460	STOWED
		3510		3240		3100		3010		2940		2890		2850		2820	RET
		3910		3530		3340		3200		3110		3040		2980		2940	EXT
	2620		2420		2320		2250		2200		2170		2140		2120	FIXED	

# CODE 26

## MAIN BOOM

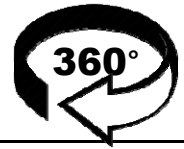
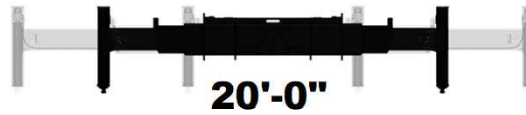

LOAD RADIUS (FT)	ANGLE	LIFTING CAP. (LBS)	ANGLE	LIFTING CAP. (LBS)	ANGLE	LIFTING CAP. (LBS)	ANGLE	LIFTING CAP. (LBS)	ANGLE	LIFTING CAP. (LBS)	ANGLE	LIFTING CAP. (LBS)	ANGLE	LIFTING CAP. (LBS)	ANGLE	LIFTING CAP. (LBS)	LOAD RADIUS (FT)
LENGTH	39.3 FT		53 FT		66 FT		79 FT		92 FT		105 FT		118 FT		131 FT		
6	74°	90000															6
8	70°	90000															8
10	67°	90000	74°	79200	77°	72400											10
12	64°	90000	71°	79200	76°	68300	78°	53900									12
15	59°	82700	68°	73500	73°	61800	76°	49100	79°	37600							15
20	50°	52800	62°	54500	68°	52500	72°	42600	75°	33100	78°	28700					20
25	40°	32200	55°	33600	63°	34400	69°	34900	72°	29100	75°	25500	77°	22500			25
30	26°	21800	49°	23200	58°	23900	65°	24300	69°	24600	72°	23100	75°	20500	77°	17900	30
35			41°	16900	53°	17500	61°	18000	66°	18200	69°	18500	73°	18600	75°	16600	35
40			31°	12700	47°	13300	56°	13700	62°	14000	66°	14200	70°	14300	73°	14500	40
45			18°	9600	41°	10300	52°	10700	58°	10900	63°	11100	67°	11300	70°	11400	45
50					35°	8000	47°	8400	55°	8700	60°	8900	65°	9000	68°	9100	50
55					28°	6200	41°	6600	51°	6900	57°	7100	62°	7200	66°	7300	55
60					18°	4700	35°	5200	46°	5500	54°	5700	59°	5800	63°	5900	60
65							28°	4000	42°	4300	50°	4500	56°	4600	61°	4700	65
70							18°	3000	36°	3300	46°	3500	53°	3600	58°	3700	70
75									30°	2500	42°	2700	50°	2800	55°	2900	75
80									23°	1800	38°	2000	46°	2100	52°	2200	80
85									11°	1100	33°	1300	43°	1500	49°	1600	85
90											27°	800	39°	900	46°	1000	90
95																	95
100																	100
105																	105
110																	110
115																	115
120																	120
125																	125
130																	130
DEDUCTIONS FOR MAIN BOOM CAPACITIES	0°	18450	0°	8650	0°	4650	0°	2500	0°	950	0°	0	0°	0	0°	0	
		1570		1140		920		770		660		580		520		460	STOWED
		3510		3240		3100		3010		2940		2890		2850		2820	RET
		3910		3530		3340		3200		3110		3040		2980		2940	EXT
	2620		2420		2320		2250		2200		2170		2140		2120	FIXED	

# CODE 27

## MAIN BOOM

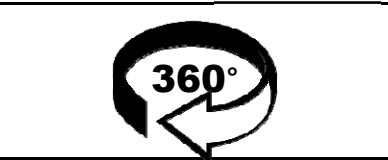
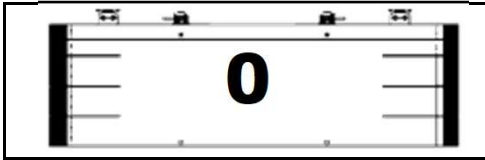

LOAD RADIUS (FT)	ANGLE	LIFTING CAP. (LBS)	ANGLE	LIFTING CAP. (LBS)	ANGLE	LIFTING CAP. (LBS)	ANGLE	LIFTING CAP. (LBS)	ANGLE	LIFTING CAP. (LBS)	ANGLE	LIFTING CAP. (LBS)	ANGLE	LIFTING CAP. (LBS)	ANGLE	LIFTING CAP. (LBS)	LOAD RADIUS (FT)
LENGTH	39.3 FT		53 FT		66 FT		79 FT		92 FT		105 FT		118 FT		131 FT		
6	74°	90000															6
8	70°	90000															8
10	67°	90000	74°	79200	77°	72400											10
12	64°	90000	71°	79200	76°	68300	78°	53900									12
15	59°	81800	68°	73500	73°	61800	76°	49100	79°	37600							15
20	50°	50700	62°	52400	68°	52500	72°	42600	75°	33100	78°	28700					20
25	40°	30800	55°	32200	63°	33000	69°	33500	72°	29100	75°	25500	77°	22500			25
30	26°	20700	49°	22100	58°	22800	65°	23200	69°	23600	72°	23100	75°	20500	77°	17900	30
35			41°	16000	53°	16700	61°	17100	66°	17400	69°	17600	73°	17800	75°	16600	35
40			31°	12000	47°	12600	56°	13000	62°	13300	66°	13500	70°	13600	73°	13800	40
45			18°	9000	41°	9700	52°	10100	58°	10300	63°	10500	67°	10700	70°	10800	45
50					35°	7500	47°	7900	55°	8100	60°	8300	65°	8500	68°	8600	50
55					28°	5800	41°	6200	51°	6400	57°	6600	62°	6700	66°	6800	55
60					18°	4300	35°	4800	46°	5000	54°	5200	59°	5400	63°	5500	60
65							28°	3600	42°	3900	50°	4100	56°	4200	61°	4300	65
70							18°	2700	36°	3000	46°	3100	53°	3300	58°	3400	70
75									30°	2200	42°	2300	50°	2500	55°	2600	75
80									23°	1500	38°	1700	46°	1800	52°	1900	80
85									11°	800	33°	1100	43°	1200	49°	1300	85
90															46°	800	90
95																	95
100																	100
105																	105
110																	110
115																	115
120																	120
125																	125
130																	130
DEDUCTIONS FOR MAIN BOOM CAPACITIES	0°	17450	0°	8050	0°	4250	0°	2150	0°	650	0°	0	0°	0	0°	0	
		1570		1140		920		770		660		580		520		460	STOWED
		3510		3240		3100		3010		2940		2890		2850		2820	RET
		3910		3530		3340		3200		3110		3040		2980		2940	EXT
	2620		2420		2320		2250		2200		2170		2140		2120	FIXED	

# CODE 28

## MAIN BOOM



LOAD RADIUS (FT)	ANGLE	LIFTING CAP. (LBS)	ANGLE	LIFTING CAP. (LBS)	ANGLE	LIFTING CAP. (LBS)	ANGLE	LIFTING CAP. (LBS)	ANGLE	LIFTING CAP. (LBS)	ANGLE	LIFTING CAP. (LBS)	ANGLE	LIFTING CAP. (LBS)	ANGLE	LIFTING CAP. (LBS)	LOAD RADIUS (FT)
LENGTH	39.3 FT		53 FT		66 FT		79 FT		92 FT		105 FT		118 FT		131 FT		
6	74°	90000															6
8	70°	90000															8
10	67°	90000	74°	79200	77°	72400											10
12	64°	90000	71°	79200	76°	68300	78°	53900									12
15	59°	83200	68°	73500	73°	61800	76°	49100	79°	37600							15
20	50°	64800	62°	61700	68°	52500	72°	42600	75°	33100	78°	28700					20
25	40°	50300	55°	51200	63°	45500	69°	37100	72°	29100	75°	25500	77°	22500			25
30	26°	40400	49°	41400	58°	39800	65°	32900	69°	25700	72°	23100	75°	20500	77°	17900	30
35			41°	34200	53°	34800	61°	29300	66°	23200	69°	20700	73°	18600	75°	16600	35
40			31°	27100	47°	27800	56°	26100	62°	20700	66°	18700	70°	16900	73°	15200	40
45			18°	22000	41°	22700	52°	23100	58°	18700	63°	16900	67°	15300	70°	13900	45
50					35°	18900	47°	19300	55°	16900	60°	15300	65°	14000	68°	12700	50
55					28°	15900	41°	16300	51°	15400	57°	14000	62°	12800	66°	11900	55
60					18°	13400	35°	13900	46°	14000	54°	12700	59°	11900	63°	10900	60
65							28°	11900	42°	12200	50°	11900	56°	10900	61°	10000	65
70							18°	10300	36°	10600	46°	10700	53°	10000	58°	9200	70
75									30°	9200	42°	9400	50°	9200	55°	8500	75
80									23°	8000	38°	8200	46°	8300	52°	7800	80
85									11°	6900	33°	7100	43°	7300	49°	7200	85
90											27°	6200	39°	6400	46°	6500	90
95											19°	5400	34°	5600	43°	5700	95
100													29°	4900	39°	5000	100
105													23°	4200	36°	4300	105
110													14°	3600	31°	3800	110
115															26°	3200	115
120															19°	2700	120
125															6°	2300	125
130																	130
DEDUCTIONS FOR MAIN BOOM CAPACITIES	0°	30500	0°	18550	0°	13200	0°	8600	0°	6500	0°	4350	0°	3200	0°	600	
		1570		1140		920		770		660		580		520		460	STOWED
		3510		3240		3100		3010		2940		2890		2850		2820	RET
		3910		3530		3340		3200		3110		3040		2980		2940	EXT
	2620		2420		2320		2250		2200		2170		2140		2120	FIXED	

# CODE 29

## MAIN BOOM



LOAD RADIUS (FT)	ANGLE	LIFTING CAP. (LBS)	ANGLE	LIFTING CAP. (LBS)	ANGLE	LIFTING CAP. (LBS)	ANGLE	LIFTING CAP. (LBS)	ANGLE	LIFTING CAP. (LBS)	ANGLE	LIFTING CAP. (LBS)	ANGLE	LIFTING CAP. (LBS)	ANGLE	LIFTING CAP. (LBS)	LOAD RADIUS (FT)
LENGTH	39.3 FT		53 FT		66 FT		79 FT		92 FT		105 FT		118 FT		131 FT		
6	74°	90000															6
8	70°	90000															8
10	67°	90000	74°	79200	77°	72400											10
12	64°	90000	71°	79200	76°	68300	78°	53900									12
15	59°	83200	68°	73500	73°	61800	76°	49100	79°	37600							15
20	50°	64200	62°	61700	68°	52500	72°	42600	75°	33100	78°	28700					20
25	40°	49700	55°	50700	63°	45500	69°	37100	72°	29100	75°	25500	77°	22500			25
30	26°	39900	49°	41000	58°	39800	65°	32900	69°	25700	72°	23100	75°	20500	77°	17900	30
35			41°	33400	53°	34000	61°	29300	66°	23200	69°	20700	73°	18600	75°	16600	35
40			31°	26400	47°	27100	56°	26100	62°	20700	66°	18700	70°	16900	73°	15200	40
45			18°	21400	41°	22100	52°	22500	58°	18700	63°	16900	67°	15300	70°	13900	45
50					35°	18300	47°	18700	55°	16900	60°	15300	65°	14000	68°	12700	50
55					28°	15400	41°	15800	51°	15400	57°	14000	62°	12800	66°	11900	55
60					18°	13000	35°	13500	46°	13700	54°	12700	59°	11900	63°	10900	60
65							28°	11500	42°	11800	50°	11900	56°	10900	61°	10000	65
70							18°	9900	36°	10200	46°	10400	53°	10000	58°	9200	70
75									30°	8800	42°	9000	50°	9200	55°	8500	75
80									23°	7700	38°	7900	46°	8000	52°	7800	80
85									11°	6600	33°	6800	43°	7000	49°	7100	85
90											27°	5900	39°	6100	46°	6200	90
95											19°	5200	34°	5300	43°	5400	95
100													29°	4600	39°	4700	100
105													23°	4000	36°	4100	105
110													14°	3400	31°	3500	110
115															26°	3000	115
120															19°	2600	120
125															6°	2100	125
130																	130
DEDUCTIONS FOR MAIN BOOM CAPACITIES	0°	30300	0°	18250	0°	12800	0°	8450	0°	6250	0°	4300	0°	3100	0°	600	
		1570		1140		920		770		660		580		520		460	STOWED
		3510		3240		3100		3010		2940		2890		2850		2820	RET
		3910		3530		3340		3200		3110		3040		2980		2940	EXT
	2620		2420		2320		2250		2200		2170		2140		2120	FIXED	

# CODE 30

## MAIN BOOM

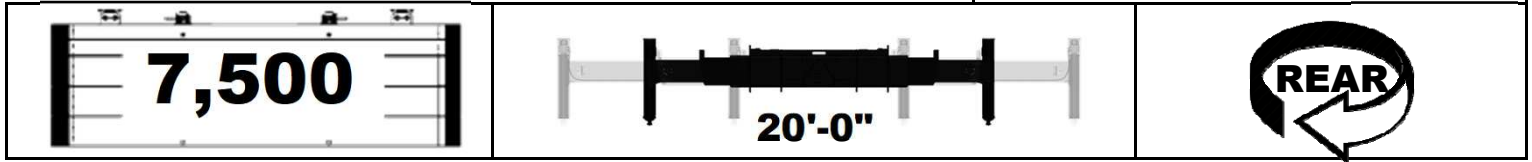

LOAD RADIUS (FT)	ANGLE	LIFTING CAP. (LBS)	ANGLE	LIFTING CAP. (LBS)	ANGLE	LIFTING CAP. (LBS)	ANGLE	LIFTING CAP. (LBS)	ANGLE	LIFTING CAP. (LBS)	ANGLE	LIFTING CAP. (LBS)	ANGLE	LIFTING CAP. (LBS)	ANGLE	LIFTING CAP. (LBS)	LOAD RADIUS (FT)
LENGTH	39.3 FT		53 FT		66 FT		79 FT		92 FT		105 FT		118 FT		131 FT		
6	74°	90000															6
8	70°	90000															8
10	67°	90000	74°	79200	77°	72400											10
12	64°	90000	71°	79200	76°	68300	78°	53900									12
15	59°	83200	68°	73500	73°	61800	76°	49100	79°	37600							15
20	50°	63500	62°	61700	68°	52500	72°	42600	75°	33100	78°	28700					20
25	40°	49200	55°	50200	63°	45500	69°	37100	72°	29100	75°	25500	77°	22500			25
30	26°	39500	49°	40500	58°	39800	65°	32900	69°	25700	72°	23100	75°	20500	77°	17900	30
35			41°	32500	53°	33200	61°	29300	66°	23200	69°	20700	73°	18600	75°	16600	35
40			31°	25700	47°	26400	56°	26100	62°	20700	66°	18700	70°	16900	73°	15200	40
45			18°	20800	41°	21500	52°	21900	58°	18700	63°	16900	67°	15300	70°	13900	45
50					35°	17800	47°	18200	55°	16900	60°	15300	65°	14000	68°	12700	50
55					28°	14900	41°	15300	51°	15400	57°	14000	62°	12800	66°	11900	55
60					18°	12500	35°	13000	46°	13300	54°	12700	59°	11900	63°	10900	60
65							28°	11100	42°	11400	50°	11600	56°	10900	61°	10000	65
70							18°	9500	36°	9800	46°	10000	53°	10000	58°	9200	70
75									30°	8500	42°	8700	50°	8800	55°	8500	75
80									23°	7400	38°	7600	46°	7700	52°	7800	80
85									11°	6300	33°	6600	43°	6700	49°	6800	85
90											27°	5700	39°	5800	46°	5900	90
95											19°	4900	34°	5100	43°	5200	95
100													29°	4400	39°	4500	100
105													23°	3800	36°	3900	105
110													14°	3200	31°	3300	110
115															26°	2800	115
120															19°	2400	120
125															6°	1900	125
130																	130
DEDUCTIONS FOR MAIN BOOM CAPACITIES	0°	30100	0°	17900	0°	12350	0°	8350	0°	6050	0°	4250	0°	3000	0°	600	
		1570		1140		920		770		660		580		520		460	STOWED
		3510		3240		3100		3010		2940		2890		2850		2820	RET
		3910		3530		3340		3200		3110		3040		2980		2940	EXT
	2620		2420		2320		2250		2200		2170		2140		2120	FIXED	



# CODE 31

## MAIN BOOM

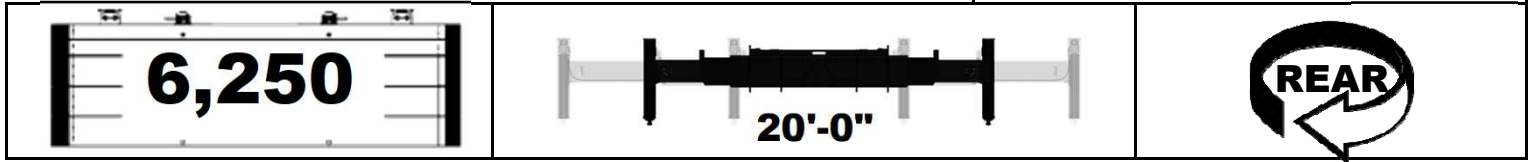

LOAD RADIUS (FT)	ANGLE	LIFTING CAP. (LBS)	ANGLE	LIFTING CAP. (LBS)	ANGLE	LIFTING CAP. (LBS)	ANGLE	LIFTING CAP. (LBS)	ANGLE	LIFTING CAP. (LBS)	ANGLE	LIFTING CAP. (LBS)	ANGLE	LIFTING CAP. (LBS)	ANGLE	LIFTING CAP. (LBS)	LOAD RADIUS (FT)
LENGTH	39.3 FT		53 FT		66 FT		79 FT		92 FT		105 FT		118 FT		131 FT		
6	74°	90000															6
8	70°	90000															8
10	67°	90000	74°	79200	77°	72400											10
12	64°	90000	71°	79200	76°	68300	78°	53900									12
15	59°	83200	68°	73500	73°	61800	76°	49100	79°	37600							15
20	50°	62900	62°	61700	68°	52500	72°	42600	75°	33100	78°	28700					20
25	40°	48700	55°	49700	63°	45500	69°	37100	72°	29100	75°	25500	77°	22500			25
30	26°	39000	49°	40100	58°	39800	65°	32900	69°	25700	72°	23100	75°	20500	77°	17900	30
35			41°	31700	53°	32300	61°	29300	66°	23200	69°	20700	73°	18600	75°	16600	35
40			31°	25000	47°	25600	56°	26000	62°	20700	66°	18700	70°	16900	73°	15200	40
45			18°	20200	41°	20900	52°	21200	58°	18700	63°	16900	67°	15300	70°	13900	45
50					35°	17300	47°	17700	55°	16900	60°	15300	65°	14000	68°	12700	50
55					28°	14400	41°	14800	51°	15100	57°	14000	62°	12800	66°	11900	55
60					18°	12100	35°	12600	46°	12900	54°	12700	59°	11900	63°	10900	60
65							28°	10800	42°	11000	50°	11200	56°	10900	61°	10000	65
70							18°	9200	36°	9500	46°	9700	53°	9800	58°	9200	70
75									30°	8200	42°	8400	50°	8500	55°	8500	75
80									23°	7000	38°	7200	46°	7400	52°	7500	80
85									11°	6000	33°	6300	43°	6400	49°	6500	85
90											27°	5400	39°	5600	46°	5700	90
95											19°	4700	34°	4800	43°	4900	95
100													29°	4100	39°	4200	100
105													23°	3500	36°	3700	105
110													14°	3000	31°	3100	110
115															26°	2600	115
120															19°	2200	120
125															6°	1700	125
130																	130
DEDUCTIONS FOR MAIN BOOM CAPACITIES	0°	29850	0°	17550	0°	11950	0°	8250	0°	5800	0°	4100	0°	2800	0°	600	
		1570		1140		920		770		660		580		520		460	STOWED
		3510		3240		3100		3010		2940		2890		2850		2820	RET
		3910		3530		3340		3200		3110		3040		2980		2940	EXT
		2620		2420		2320		2250		2200		2170		2140		2120	FIXED

# CODE 32

## MAIN BOOM



LOAD RADIUS (FT)	ANGLE	LIFTING CAP. (LBS)	ANGLE	LIFTING CAP. (LBS)	ANGLE	LIFTING CAP. (LBS)	ANGLE	LIFTING CAP. (LBS)	ANGLE	LIFTING CAP. (LBS)	ANGLE	LIFTING CAP. (LBS)	ANGLE	LIFTING CAP. (LBS)	ANGLE	LIFTING CAP. (LBS)	LOAD RADIUS (FT)
LENGTH	39.3 FT		53 FT		66 FT		79 FT		92 FT		105 FT		118 FT		131 FT		
6	74°	90000															6
8	70°	90000															8
10	67°	90000	74°	79200	77°	72400											10
12	64°	90000	71°	79200	76°	68300	78°	53900									12
15	59°	83200	68°	73500	73°	61800	76°	49100	79°	37600							15
20	50°	62300	62°	61700	68°	52500	72°	42600	75°	33100	78°	28700					20
25	40°	48200	55°	49200	63°	45500	69°	37100	72°	29100	75°	25500	77°	22500			25
30	26°	38600	49°	39600	58°	39800	65°	32900	69°	25700	72°	23100	75°	20500	77°	17900	30
35			41°	30800	53°	31500	61°	29300	66°	23200	69°	20700	73°	18600	75°	16600	35
40			31°	24300	47°	24900	56°	25300	62°	20700	66°	18700	70°	16900	73°	15200	40
45			18°	19600	41°	20200	52°	20600	58°	18700	63°	16900	67°	15300	70°	13900	45
50					35°	16700	47°	17100	55°	16900	60°	15300	65°	14000	68°	12700	50
55					28°	14000	41°	14400	51°	14600	57°	14000	62°	12800	66°	11900	55
60					18°	11700	35°	12200	46°	12400	54°	12600	59°	11900	63°	10900	60
65							28°	10400	42°	10600	50°	10800	56°	10900	61°	10000	65
70							18°	8800	36°	9100	46°	9300	53°	9400	58°	9200	70
75									30°	7900	42°	8000	50°	8200	55°	8300	75
80									23°	6700	38°	6900	46°	7100	52°	7200	80
85									11°	5800	33°	6000	43°	6100	49°	6200	85
90											27°	5200	39°	5300	46°	5400	90
95											19°	4400	34°	4600	43°	4700	95
100													29°	3900	39°	4000	100
105													23°	3300	36°	3400	105
110													14°	2800	31°	2900	110
115															26°	2400	115
120															19°	2000	120
125															6°	1500	125
130																	130
DEDUCTIONS FOR MAIN BOOM CAPACITIES	0°	29700	0°	17250	0°	11600	0°	8050	0°	5600	0°	3850	0°	2600	0°	600	
		1570		1140		920		770		660		580		520		460	STOWED
		3510		3240		3100		3010		2940		2890		2850		2820	RET
		3910		3530		3340		3200		3110		3040		2980		2940	EXT
	2620		2420		2320		2250		2200		2170		2140		2120	FIXED	

# CODE 33

## MAIN BOOM



LOAD RADIUS (FT)	ANGLE	LIFTING CAP. (LBS)	ANGLE	LIFTING CAP. (LBS)	ANGLE	LIFTING CAP. (LBS)	ANGLE	LIFTING CAP. (LBS)	ANGLE	LIFTING CAP. (LBS)	ANGLE	LIFTING CAP. (LBS)	ANGLE	LIFTING CAP. (LBS)	ANGLE	LIFTING CAP. (LBS)	LOAD RADIUS (FT)
LENGTH	39.3 FT		53 FT		66 FT		79 FT		92 FT		105 FT		118 FT		131 FT		
6	74°	90000															6
8	70°	90000															8
10	67°	90000	74°	79200	77°	72400											10
12	64°	90000	71°	79200	76°	68300	78°	53900									12
15	59°	83200	68°	73500	73°	61800	76°	49100	79°	37600							15
20	50°	61600	62°	61700	68°	52500	72°	42600	75°	33100	78°	28700					20
25	40°	47700	55°	48600	63°	45500	69°	37100	72°	29100	75°	25500	77°	22500			25
30	26°	38100	49°	39200	58°	39700	65°	32900	69°	25700	72°	23100	75°	20500	77°	17900	30
35			41°	30000	53°	30600	61°	29300	66°	23200	69°	20700	73°	18600	75°	16600	35
40			31°	23600	47°	24200	56°	24600	62°	20700	66°	18700	70°	16900	73°	15200	40
45			18°	19000	41°	19600	52°	20000	58°	18700	63°	16900	67°	15300	70°	13900	45
50					35°	16200	47°	16600	55°	16800	60°	15300	65°	14000	68°	12700	50
55					28°	13500	41°	13900	51°	14200	57°	14000	62°	12800	66°	11900	55
60					18°	11300	35°	11800	46°	12000	54°	12200	59°	11900	63°	10900	60
65							28°	10000	42°	10200	50°	10400	56°	10600	61°	10000	65
70							18°	8500	36°	8800	46°	9000	53°	9100	58°	9200	70
75									30°	7500	42°	7700	50°	7800	55°	7900	75
80									23°	6400	38°	6600	46°	6800	52°	6900	80
85									11°	5500	33°	5700	43°	5900	49°	5900	85
90											27°	4900	39°	5000	46°	5100	90
95											19°	4100	34°	4300	43°	4400	95
100													29°	3700	39°	3800	100
105													23°	3100	36°	3200	105
110													14°	2600	31°	2700	110
115															26°	2200	115
120															19°	1800	120
125															6°	1400	125
130																	130
DEDUCTIONS FOR MAIN BOOM CAPACITIES	0°	29450	0°	16900	0°	11200	0°	7700	0°	5300	0°	3600	0°	2400	0°	600	
		1570		1140		920		770		660		580		520		460	STOWED
		3510		3240		3100		3010		2940		2890		2850		2820	RET
		3910		3530		3340		3200		3110		3040		2980		2940	EXT
	2620		2420		2320		2250		2200		2170		2140		2120	FIXED	

# CODE 34

## MAIN BOOM

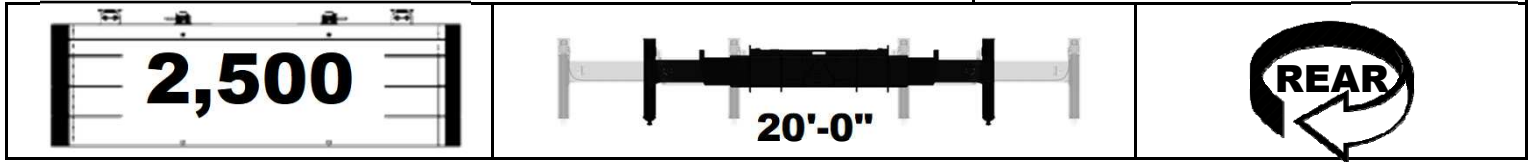

LOAD RADIUS (FT)	ANGLE	LIFTING CAP. (LBS)	ANGLE	LIFTING CAP. (LBS)	ANGLE	LIFTING CAP. (LBS)	ANGLE	LIFTING CAP. (LBS)	ANGLE	LIFTING CAP. (LBS)	ANGLE	LIFTING CAP. (LBS)	ANGLE	LIFTING CAP. (LBS)	ANGLE	LIFTING CAP. (LBS)	LOAD RADIUS (FT)
LENGTH	39.3 FT		53 FT		66 FT		79 FT		92 FT		105 FT		118 FT		131 FT		
6	74°	90000															6
8	70°	90000															8
10	67°	90000	74°	79200	77°	72400											10
12	64°	90000	71°	79200	76°	68300	78°	53900									12
15	59°	83200	68°	73500	73°	61800	76°	49100	79°	37600							15
20	50°	61000	62°	61700	68°	52500	72°	42600	75°	33100	78°	28700					20
25	40°	47100	55°	48100	63°	45500	69°	37100	72°	29100	75°	25500	77°	22500			25
30	26°	37100	49°	38400	58°	39100	65°	32900	69°	25700	72°	23100	75°	20500	77°	17900	30
35			41°	29100	53°	29800	61°	29300	66°	23200	69°	20700	73°	18600	75°	16600	35
40			31°	22900	47°	23500	56°	23900	62°	20700	66°	18700	70°	16900	73°	15200	40
45			18°	18300	41°	19000	52°	19400	58°	18700	63°	16900	67°	15300	70°	13900	45
50					35°	15700	47°	16100	55°	16300	60°	15300	65°	14000	68°	12700	50
55					28°	13000	41°	13400	51°	13700	57°	13900	62°	12800	66°	11900	55
60					18°	10800	35°	11300	46°	11600	54°	11800	59°	11900	63°	10900	60
65							28°	9600	42°	9900	50°	10000	56°	10200	61°	10000	65
70							18°	8100	36°	8400	46°	8600	53°	8700	58°	8800	70
75									30°	7200	42°	7400	50°	7500	55°	7600	75
80									23°	6100	38°	6300	46°	6500	52°	6600	80
85									11°	5200	33°	5400	43°	5600	49°	5700	85
90											27°	4600	39°	4800	46°	4900	90
95											19°	3900	34°	4100	43°	4200	95
100													29°	3400	39°	3500	100
105													23°	2900	36°	3000	105
110													14°	2300	31°	2500	110
115															26°	2000	115
120															19°	1600	120
125															6°	1200	125
130																	130
DEDUCTIONS FOR MAIN BOOM CAPACITIES	0°	29000	0°	16500	0°	10700	0°	7350	0°	5000	0°	3400	0°	2100	0°	600	
		1570		1140		920		770		660		580		520		460	STOWED
		3510		3240		3100		3010		2940		2890		2850		2820	RET
		3910		3530		3340		3200		3110		3040		2980		2940	EXT
	2620		2420		2320		2250		2200		2170		2140		2120	FIXED	

# CODE 35

## MAIN BOOM

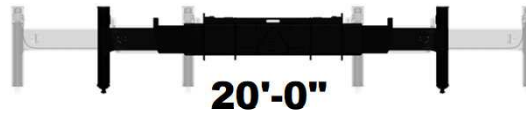

LOAD RADIUS (FT)	ANGLE	LIFTING CAP. (LBS)	ANGLE	LIFTING CAP. (LBS)	ANGLE	LIFTING CAP. (LBS)	ANGLE	LIFTING CAP. (LBS)	ANGLE	LIFTING CAP. (LBS)	ANGLE	LIFTING CAP. (LBS)	ANGLE	LIFTING CAP. (LBS)	ANGLE	LIFTING CAP. (LBS)	LOAD RADIUS (FT)
LENGTH	39.3 FT		53 FT		66 FT		79 FT		92 FT		105 FT		118 FT		131 FT		
6	74°	90000															6
8	70°	90000															8
10	67°	90000	74°	79200	77°	72400											10
12	64°	90000	71°	79200	76°	68300	78°	53900									12
15	59°	82700	68°	73500	73°	61800	76°	49100	79°	37600							15
20	50°	60300	62°	61300	68°	52500	72°	42600	75°	33100	78°	28700					20
25	40°	46600	55°	47600	63°	45500	69°	37100	72°	29100	75°	25500	77°	22500			25
30	26°	36000	49°	37400	58°	38100	65°	32900	69°	25700	72°	23100	75°	20500	77°	17900	30
35			41°	28300	53°	28900	61°	29300	66°	23200	69°	20700	73°	18600	75°	16600	35
40			31°	22100	47°	22800	56°	23200	62°	20700	66°	18700	70°	16900	73°	15200	40
45			18°	17700	41°	18400	52°	18800	58°	18700	63°	16900	67°	15300	70°	13900	45
50					35°	15100	47°	15500	55°	15800	60°	15300	65°	14000	68°	12700	50
55					28°	12500	41°	13000	51°	13200	57°	13400	62°	12800	66°	11900	55
60					18°	10400	35°	10900	46°	11200	54°	11300	59°	11500	63°	10900	60
65							28°	9200	42°	9500	50°	9700	56°	9800	61°	9900	65
70							18°	7800	36°	8100	46°	8200	53°	8400	58°	8500	70
75									30°	6900	42°	7100	50°	7200	55°	7300	75
80									23°	5800	38°	6000	46°	6200	52°	6300	80
85									11°	4900	33°	5100	43°	5300	49°	5400	85
90											27°	4400	39°	4500	46°	4600	90
95											19°	3700	34°	3800	43°	3900	95
100													29°	3200	39°	3300	100
105													23°	2600	36°	2800	105
110													14°	2100	31°	2300	110
115															26°	1800	115
120															19°	1400	120
125															6°	1000	125
130																	130
DEDUCTIONS FOR MAIN BOOM CAPACITIES	0°	28500	0°	16200	0°	10300	0°	7050	0°	4700	0°	3150	0°	1900	0°	600	
		1570		1140		920		770		660		580		520		460	STOWED
		3510		3240		3100		3010		2940		2890		2850		2820	RET
		3910		3530		3340		3200		3110		3040		2980		2940	EXT
	2620		2420		2320		2250		2200		2170		2140		2120	FIXED	

# CODE 36

## MAIN BOOM

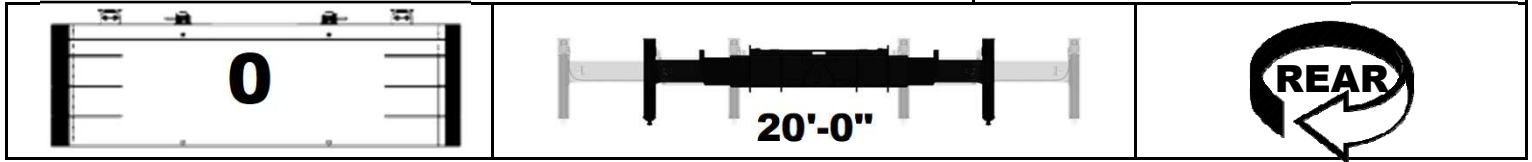

LOAD RADIUS (FT)	ANGLE	LIFTING CAP. (LBS)	ANGLE	LIFTING CAP. (LBS)	ANGLE	LIFTING CAP. (LBS)	ANGLE	LIFTING CAP. (LBS)	ANGLE	LIFTING CAP. (LBS)	ANGLE	LIFTING CAP. (LBS)	ANGLE	LIFTING CAP. (LBS)	ANGLE	LIFTING CAP. (LBS)	LOAD RADIUS (FT)
LENGTH	39.3 FT		53 FT		66 FT		79 FT		92 FT		105 FT		118 FT		131 FT		
6	74°	90000															6
8	70°	90000															8
10	67°	90000	74°	79200	77°	72400											10
12	64°	90000	71°	79200	76°	68300	78°	53900									12
15	59°	81800	68°	73500	73°	61800	76°	49100	79°	37600							15
20	50°	59700	62°	60600	68°	52500	72°	42600	75°	33100	78°	28700					20
25	40°	46100	55°	47100	63°	45500	69°	37100	72°	29100	75°	25500	77°	22500			25
30	26°	34900	49°	36300	58°	37000	65°	32900	69°	25700	72°	23100	75°	20500	77°	17900	30
35			41°	27400	53°	28100	61°	28500	66°	23200	69°	20700	73°	18600	75°	16600	35
40			31°	21400	47°	22100	56°	22500	62°	20700	66°	18700	70°	16900	73°	15200	40
45			18°	17100	41°	17800	52°	18200	58°	18500	63°	16900	67°	15300	70°	13900	45
50					35°	14600	47°	15000	55°	15200	60°	15300	65°	14000	68°	12700	50
55					28°	12100	41°	12500	51°	12700	57°	12900	62°	12800	66°	11900	55
60					18°	10000	35°	10500	46°	10700	54°	10900	59°	11000	63°	10900	60
65							28°	8800	42°	9100	50°	9300	56°	9400	61°	9500	65
70							18°	7400	36°	7700	46°	7900	53°	8000	58°	8100	70
75									30°	6500	42°	6700	50°	6900	55°	7000	75
80									23°	5500	38°	5700	46°	5900	52°	6000	80
85									11°	4600	33°	4900	43°	5000	49°	5100	85
90											27°	4100	39°	4200	46°	4300	90
95											19°	3400	34°	3600	43°	3700	95
100													29°	3000	39°	3100	100
105													23°	2400	36°	2500	105
110													14°	1900	31°	2000	110
115															26°	1600	115
120															19°	1200	120
125															6°	800	125
130																	130
DEDUCTIONS FOR MAIN BOOM CAPACITIES	0°	28050	0°	15750	0°	9900	0°	6700	0°	4400	0°	2900	0°	1700	0°	600	
		1570		1140		920		770		660		580		520		460	STOWED
		3510		3240		3100		3010		2940		2890		2850		2820	RET
		3910		3530		3340		3200		3110		3040		2980		2940	EXT
	2620		2420		2320		2250		2200		2170		2140		2120	FIXED	

# CODE 37

## MAIN BOOM



**10,000**

**17'-6"**

**360°**

LOAD RADIUS (FT)	ANGLE	LIFTING CAP. (LBS)	ANGLE	LIFTING CAP. (LBS)	ANGLE	LIFTING CAP. (LBS)	ANGLE	LIFTING CAP. (LBS)	ANGLE	LIFTING CAP. (LBS)	ANGLE	LIFTING CAP. (LBS)	ANGLE	LIFTING CAP. (LBS)	ANGLE	LIFTING CAP. (LBS)	LOAD RADIUS (FT)	
<b>LENGTH</b>		<b>39.3 FT</b>		<b>53 FT</b>		<b>66 FT</b>		<b>79 FT</b>		<b>92 FT</b>		<b>105 FT</b>		<b>118 FT</b>		<b>131 FT</b>		
6	74°	90000																6
8	70°	90000																8
10	67°	90000	74°	79200	77°	72400												10
12	64°	90000	71°	79200	76°	68300	78°	53900										12
15	59°	83200	68°	73500	73°	61800	76°	49100	79°	37600								15
20	50°	52300	62°	53800	68°	52500	72°	42600	75°	33100	78°	28700						20
25	40°	33500	55°	34800	63°	35500	69°	36000	72°	29100	75°	25500	77°	22500				25
30	26°	23400	49°	24700	58°	25300	65°	25800	69°	25700	72°	23100	75°	20500	77°	17900		30
35			41°	18400	53°	19100	61°	19400	66°	19700	69°	19900	73°	18600	75°	16600		35
40			31°	14100	47°	14800	56°	15100	62°	15400	66°	15600	70°	15700	73°	15200		40
45			18°	11000	41°	11700	52°	12000	58°	12300	63°	12500	67°	12600	70°	12700		45
50					35°	9300	47°	9700	55°	9900	60°	10100	65°	10200	68°	10300		50
55					28°	7400	41°	7800	51°	8000	57°	8200	62°	8400	66°	8500		55
60					18°	5800	35°	6300	46°	6500	54°	6700	59°	6900	63°	6900		60
65							28°	5000	42°	5300	50°	5500	56°	5600	61°	5700		65
70							18°	4000	36°	4300	46°	4400	53°	4600	58°	4700		70
75									30°	3400	42°	3600	50°	3700	55°	3800		75
80									23°	2600	38°	2800	46°	2900	52°	3000		80
85									11°	1900	33°	2100	43°	2300	49°	2400		85
90											27°	1500	39°	1700	46°	1800		90
95											19°	1000	34°	1200	43°	1300		95
100													29°	700	39°	800		100
105																		105
110																		110
115																		115
120																		120
125																		125
130																		130
DEDUCTIONS FOR MAIN BOOM CAPACITIES	0°	20050	0°	10000	0°	5750	0°	3400	0°	1750	0°	600	0°	0	0°	0		
		1570		1140		920		770		660		580		520		460		STOWED
		3510		3240		3100		3010		2940		2890		2850		2820		RET
		3910		3530		3340		3200		3110		3040		2980		2940		EXT
	2620		2420		2320		2250		2200		2170		2140		2120		FIXED	

# CODE 38

## MAIN BOOM

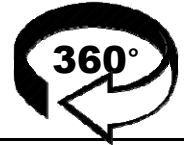

LOAD RADIUS (FT)	ANGLE	LIFTING CAP. (LBS)	ANGLE	LIFTING CAP. (LBS)	ANGLE	LIFTING CAP. (LBS)	ANGLE	LIFTING CAP. (LBS)	ANGLE	LIFTING CAP. (LBS)	ANGLE	LIFTING CAP. (LBS)	ANGLE	LIFTING CAP. (LBS)	ANGLE	LIFTING CAP. (LBS)	LOAD RADIUS (FT)
LENGTH	39.3 FT		53 FT		66 FT		79 FT		92 FT		105 FT		118 FT		131 FT		
6	74°	90000															6
8	70°	90000															8
10	67°	90000	74°	79200	77°	72400											10
12	64°	90000	71°	79200	76°	68300	78°	53900									12
15	59°	83200	68°	73500	73°	61800	76°	49100	79°	37600							15
20	50°	50500	62°	52000	68°	52500	72°	42600	75°	33100	78°	28700					20
25	40°	32200	55°	33600	63°	34300	69°	34700	72°	29100	75°	25500	77°	22500			25
30	26°	22500	49°	23700	58°	24400	65°	24800	69°	25100	72°	23100	75°	20500	77°	17900	30
35			41°	17700	53°	18300	61°	18700	66°	19000	69°	19200	73°	18600	75°	16600	35
40			31°	13500	47°	14100	56°	14500	62°	14800	66°	15000	70°	15100	73°	15200	40
45			18°	10400	41°	11100	52°	11500	58°	11700	63°	11900	67°	12000	70°	12200	45
50					35°	8800	47°	9200	55°	9400	60°	9600	65°	9700	68°	9800	50
55					28°	7000	41°	7400	51°	7600	57°	7800	62°	7900	66°	8000	55
60					18°	5400	35°	5900	46°	6200	54°	6300	59°	6500	63°	6600	60
65							28°	4700	42°	4900	50°	5100	56°	5300	61°	5400	65
70							18°	3700	36°	3900	46°	4100	53°	4200	58°	4300	70
75									30°	3100	42°	3300	50°	3400	55°	3500	75
80									23°	2300	38°	2500	46°	2700	52°	2800	80
85									11°	1600	33°	1900	43°	2000	49°	2100	85
90											27°	1300	39°	1400	46°	1500	90
95											19°	800	34°	900	43°	1000	95
100																	100
105																	105
110																	110
115																	115
120																	120
125																	125
130																	130
DEDUCTIONS FOR MAIN BOOM CAPACITIES	0°	19200	0°	9450	0°	5350	0°	3100	0°	1450	0°	0	0°	0	0°	0	
		1570		1140		920		770		660		580		520		460	STOWED
		3510		3240		3100		3010		2940		2890		2850		2820	RET
		3910		3530		3340		3200		3110		3040		2980		2940	EXT
	2620		2420		2320		2250		2200		2170		2140		2120	FIXED	



# CODE 39

## MAIN BOOM



**7,500**

**17'-6"**

**360°**

LOAD RADIUS (FT)	ANGLE	LIFTING CAP. (LBS)	ANGLE	LIFTING CAP. (LBS)	ANGLE	LIFTING CAP. (LBS)	ANGLE	LIFTING CAP. (LBS)	ANGLE	LIFTING CAP. (LBS)	ANGLE	LIFTING CAP. (LBS)	ANGLE	LIFTING CAP. (LBS)	ANGLE	LIFTING CAP. (LBS)	LOAD RADIUS (FT)
LENGTH	39.3 FT		53 FT		66 FT		79 FT		92 FT		105 FT		118 FT		131 FT		
6	74°	90000															6
8	70°	90000															8
10	67°	90000	74°	79200	77°	72400											10
12	64°	90000	71°	79200	76°	68300	78°	53900									12
15	59°	83200	68°	73500	73°	61800	76°	49100	79°	37600							15
20	50°	48700	62°	50300	68°	51100	72°	42600	75°	33100	78°	28700					20
25	40°	31000	55°	32300	63°	33000	69°	33500	72°	29100	75°	25500	77°	22500			25
30	26°	21500	49°	22800	58°	23500	65°	23900	69°	24200	72°	23100	75°	20500	77°	17900	30
35			41°	16900	53°	17500	61°	17900	66°	18200	69°	18400	73°	18600	75°	16600	35
40			31°	12900	47°	13500	56°	13900	62°	14100	66°	14300	70°	14500	73°	14600	40
45			18°	9900	41°	10500	52°	10900	58°	11200	63°	11400	67°	11500	70°	11600	45
50					35°	8300	47°	8700	55°	8900	60°	9100	65°	9200	68°	9400	50
55					28°	6500	41°	6900	51°	7200	57°	7400	62°	7500	66°	7600	55
60					18°	5000	35°	5500	46°	5800	54°	5900	59°	6100	63°	6200	60
65							28°	4300	42°	4600	50°	4800	56°	4900	61°	5000	65
70							18°	3300	36°	3600	46°	3800	53°	3900	58°	4000	70
75									30°	2800	42°	3000	50°	3100	55°	3200	75
80									23°	2000	38°	2200	46°	2400	52°	2500	80
85									11°	1400	33°	1600	43°	1700	49°	1900	85
90											27°	1100	39°	1200	46°	1300	90
95													34°	700	43°	800	95
100																	100
105																	105
110																	110
115																	115
120																	120
125																	125
130																	130
DEDUCTIONS FOR MAIN BOOM CAPACITIES	0°	18350	0°	8950	0°	4950	0°	2800	0°	1250	0°	0	0°	0	0°	0	
		1570		1140		920		770		660		580		520		460	STOWED
		3510		3240		3100		3010		2940		2890		2850		2820	RET
		3910		3530		3340		3200		3110		3040		2980		2940	EXT
	2620		2420		2320		2250		2200		2170		2140		2120	FIXED	

# CODE 40

## MAIN BOOM



**6,250**

**17'-6"**

**360°**

LOAD RADIUS (FT)	ANGLE	LIFTING CAP. (LBS)	ANGLE	LIFTING CAP. (LBS)	ANGLE	LIFTING CAP. (LBS)	ANGLE	LIFTING CAP. (LBS)	ANGLE	LIFTING CAP. (LBS)	ANGLE	LIFTING CAP. (LBS)	ANGLE	LIFTING CAP. (LBS)	ANGLE	LIFTING CAP. (LBS)	LOAD RADIUS (FT)
LENGTH	39.3 FT		53 FT		66 FT		79 FT		92 FT		105 FT		118 FT		131 FT		
6	74°	90000															6
8	70°	90000															8
10	67°	90000	74°	79200	77°	72400											10
12	64°	90000	71°	79200	76°	68300	78°	53900									12
15	59°	83200	68°	73500	73°	61800	76°	49100	79°	37600							15
20	50°	47000	62°	48500	68°	49300	72°	42600	75°	33100	78°	28700					20
25	40°	29800	55°	31100	63°	31800	69°	32300	72°	29100	75°	25500	77°	22500			25
30	26°	20600	49°	21900	58°	22500	65°	22900	69°	23200	72°	23100	75°	20500	77°	17900	30
35			41°	16100	53°	16800	61°	17200	66°	17400	69°	17600	73°	17800	75°	16600	35
40			31°	12200	47°	12800	56°	13200	62°	13500	66°	13700	70°	13800	73°	13900	40
45			18°	9300	41°	10000	52°	10400	58°	10600	63°	10800	67°	10900	70°	11000	45
50					35°	7800	47°	8200	55°	8400	60°	8600	65°	8800	68°	8900	50
55					28°	6100	41°	6500	51°	6700	57°	6900	62°	7000	66°	7200	55
60					18°	4600	35°	5100	46°	5400	54°	5500	59°	5700	63°	5800	60
65							28°	4000	42°	4200	50°	4400	56°	4500	61°	4600	65
70							18°	3000	36°	3300	46°	3500	53°	3600	58°	3700	70
75									30°	2500	42°	2700	50°	2800	55°	2900	75
80									23°	1800	38°	2000	46°	2100	52°	2200	80
85									11°	1100	33°	1300	43°	1500	49°	1600	85
90											27°	800	39°	900	46°	1000	90
95																	95
100																	100
105																	105
110																	110
115																	115
120																	120
125																	125
130																	130
DEDUCTIONS FOR MAIN BOOM CAPACITIES	0°	17500	0°	8400	0°	4550	0°	2500	0°	950	0°	0	0°	0	0°	0	
		1570		1140		920		770		660		580		520		460	STOWED
		3510		3240		3100		3010		2940		2890		2850		2820	RET
		3910		3530		3340		3200		3110		3040		2980		2940	EXT
	2620		2420		2320		2250		2200		2170		2140		2120	FIXED	

# CODE 41

## MAIN BOOM



**5,000**

**17'-6"**

**360°**

LOAD RADIUS (FT)	ANGLE	LIFTING CAP. (LBS)	ANGLE	LIFTING CAP. (LBS)	ANGLE	LIFTING CAP. (LBS)	ANGLE	LIFTING CAP. (LBS)	ANGLE	LIFTING CAP. (LBS)	ANGLE	LIFTING CAP. (LBS)	ANGLE	LIFTING CAP. (LBS)	ANGLE	LIFTING CAP. (LBS)	LOAD RADIUS (FT)
<b>LENGTH</b>		<b>39.3 FT</b>		<b>53 FT</b>		<b>66 FT</b>		<b>79 FT</b>		<b>92 FT</b>		<b>105 FT</b>		<b>118 FT</b>		<b>131 FT</b>	
6	74°	90000															6
8	70°	90000															8
10	67°	90000	74°	79200	77°	72400											10
12	64°	90000	71°	79200	76°	68300	78°	53900									12
15	59°	83200	68°	73500	73°	61800	76°	49100	79°	37600							15
20	50°	45200	62°	46700	68°	47500	72°	42600	75°	33100	78°	28700					20
25	40°	28500	55°	29800	63°	30600	69°	31000	72°	29100	75°	25500	77°	22500			25
30	26°	19600	49°	20900	58°	21600	65°	22000	69°	22300	72°	22500	75°	20500	77°	17900	30
35			41°	15400	53°	16000	61°	16400	66°	16700	69°	16900	73°	17000	75°	16600	35
40			31°	11600	47°	12200	56°	12600	62°	12800	66°	13000	70°	13200	73°	13300	40
45			18°	8800	41°	9400	52°	9800	58°	10100	63°	10200	67°	10400	70°	10500	45
50					35°	7300	47°	7700	55°	8000	60°	8100	65°	8300	68°	8400	50
55					28°	5700	41°	6100	51°	6300	57°	6500	62°	6600	66°	6700	55
60					18°	4300	35°	4700	46°	5000	54°	5200	59°	5300	63°	5400	60
65							28°	3600	42°	3900	50°	4100	56°	4200	61°	4300	65
70							18°	2700	36°	3000	46°	3100	53°	3300	58°	3400	70
75									30°	2200	42°	2400	50°	2500	55°	2600	75
80									23°	1500	38°	1700	46°	1800	52°	1900	80
85									11°	900	33°	1100	43°	1200	49°	1300	85
90													39°	700	46°	800	90
95																	95
100																	100
105																	105
110																	110
115																	115
120																	120
125																	125
130																	130
DEDUCTIONS FOR MAIN BOOM CAPACITIES	0°	16650	0°	7900	0°	4250	0°	2150	0°	750	0°	0	0°	0	0°	0	
		1570		1140		920		770		660		580		520		460	STOWED
		3510		3240		3100		3010		2940		2890		2850		2820	RET
		3910		3530		3340		3200		3110		3040		2980		2940	EXT
	2620		2420		2320		2250		2200		2170		2140		2120	FIXED	

# CODE 42

## MAIN BOOM



**3,750**

**17'-6"**

**360°**

LOAD RADIUS (FT)	ANGLE	LIFTING CAP. (LBS)	ANGLE	LIFTING CAP. (LBS)	ANGLE	LIFTING CAP. (LBS)	ANGLE	LIFTING CAP. (LBS)	ANGLE	LIFTING CAP. (LBS)	ANGLE	LIFTING CAP. (LBS)	ANGLE	LIFTING CAP. (LBS)	ANGLE	LIFTING CAP. (LBS)	LOAD RADIUS (FT)	
<b>LENGTH</b>		<b>39.3 FT</b>		<b>53 FT</b>		<b>66 FT</b>		<b>79 FT</b>		<b>92 FT</b>		<b>105 FT</b>		<b>118 FT</b>		<b>131 FT</b>		
6	74°	90000																6
8	70°	90000																8
10	67°	90000	74°	79200	77°	72400												10
12	64°	90000	71°	79200	76°	68300	78°	53900										12
15	59°	83200	68°	73500	73°	61800	76°	49100	79°	37600								15
20	50°	43400	62°	44900	68°	45700	72°	42600	75°	33100	78°	28700						20
25	40°	27300	55°	28600	63°	29300	69°	29800	72°	29100	75°	25500	77°	22500				25
30	26°	18700	49°	20000	58°	20600	65°	21000	69°	21300	72°	21600	75°	20500	77°	17900		30
35			41°	14600	53°	15200	61°	15600	66°	15900	69°	16100	73°	16300	75°	16400		35
40			31°	10900	47°	11600	56°	11900	62°	12200	66°	12400	70°	12500	73°	12600		40
45			18°	8200	41°	8900	52°	9300	58°	9500	63°	9700	67°	9800	70°	9900		45
50					35°	6800	47°	7200	55°	7500	60°	7700	65°	7800	68°	7900		50
55					28°	5200	41°	5600	51°	5900	57°	6000	62°	6200	66°	6300		55
60					18°	3900	35°	4300	46°	4600	54°	4800	59°	4900	63°	5000		60
65							28°	3300	42°	3500	50°	3700	56°	3800	61°	3900		65
70							18°	2300	36°	2600	46°	2800	53°	2900	58°	3000		70
75									30°	1900	42°	2000	50°	2200	55°	2300		75
80									23°	1200	38°	1400	46°	1500	52°	1600		80
85											33°	800	43°	1000	49°	1100		85
90																		90
95																		95
100																		100
105																		105
110																		110
115																		115
120																		120
125																		125
130																		130
DEDUCTIONS FOR MAIN BOOM CAPACITIES	0°	15800	0°	7350	0°	3850	0°	1850	0°	450	0°	0	0°	0	0°	0		
		1570		1140		920		770		660		580		520		460		STOWED
		3510		3240		3100		3010		2940		2890		2850		2820		RET
		3910		3530		3340		3200		3110		3040		2980		2940		EXT
	2620		2420		2320		2250		2200		2170		2140		2120		FIXED	

# CODE 43

## MAIN BOOM

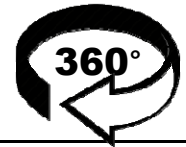

LOAD RADIUS (FT)	ANGLE	LIFTING CAP. (LBS)	ANGLE	LIFTING CAP. (LBS)	ANGLE	LIFTING CAP. (LBS)	ANGLE	LIFTING CAP. (LBS)	ANGLE	LIFTING CAP. (LBS)	ANGLE	LIFTING CAP. (LBS)	ANGLE	LIFTING CAP. (LBS)	ANGLE	LIFTING CAP. (LBS)	LOAD RADIUS (FT)
LENGTH	39.3 FT		53 FT		66 FT		79 FT		92 FT		105 FT		118 FT		131 FT		
6	74°	90000															6
8	70°	90000															8
10	67°	90000	74°	79200	77°	72400											10
12	64°	90000	71°	79200	76°	68300	78°	53900									12
15	59°	81900	68°	73500	73°	61800	76°	49100	79°	37600							15
20	50°	41600	62°	43100	68°	44000	72°	42600	75°	33100	78°	28700					20
25	40°	26100	55°	27400	63°	28100	69°	28600	72°	28900	75°	25500	77°	22500			25
30	26°	17800	49°	19000	58°	19700	65°	20100	69°	20400	72°	20600	75°	20500	77°	17900	30
35			41°	13800	53°	14500	61°	14900	66°	15100	69°	15300	73°	15500	75°	15600	35
40			31°	10300	47°	10900	56°	11300	62°	11600	66°	11700	70°	11900	73°	12000	40
45			18°	7700	41°	8300	52°	8700	58°	9000	63°	9100	67°	9300	70°	9400	45
50					35°	6400	47°	6700	55°	7000	60°	7200	65°	7300	68°	7400	50
55					28°	4800	41°	5200	51°	5400	57°	5600	62°	5800	66°	5900	55
60					18°	3500	35°	3900	46°	4200	54°	4400	59°	4500	63°	4600	60
65							28°	2900	42°	3200	50°	3300	56°	3500	61°	3600	65
70							18°	2000	36°	2300	46°	2500	53°	2600	58°	2700	70
75									30°	1600	42°	1700	50°	1900	55°	2000	75
80									23°	900	38°	1100	46°	1200	52°	1300	80
85															49°	800	85
90																	90
95																	95
100																	100
105																	105
110																	110
115																	115
120																	120
125																	125
130																	130
DEDUCTIONS FOR MAIN BOOM CAPACITIES	0°	15000	0°	6850	0°	3450	0°	1550	0°	150	0°	0	0°	0	0°	0	
		1570		1140		920		770		660		580		520		460	STOWED
		3510		3240		3100		3010		2940		2890		2850		2820	RET
		3910		3530		3340		3200		3110		3040		2980		2940	EXT
	2620		2420		2320		2250		2200		2170		2140		2120	FIXED	

# CODE 44

## MAIN BOOM

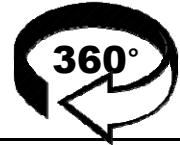

LOAD RADIUS (FT)	ANGLE	LIFTING CAP. (LBS)	ANGLE	LIFTING CAP. (LBS)	ANGLE	LIFTING CAP. (LBS)	ANGLE	LIFTING CAP. (LBS)	ANGLE	LIFTING CAP. (LBS)	ANGLE	LIFTING CAP. (LBS)	ANGLE	LIFTING CAP. (LBS)	ANGLE	LIFTING CAP. (LBS)	LOAD RADIUS (FT)
LENGTH	39.3 FT		53 FT		66 FT		79 FT		92 FT		105 FT		118 FT		131 FT		
6	74°	90000															6
8	70°	90000															8
10	67°	90000	74°	79200	77°	72400											10
12	64°	90000	71°	79200	76°	68300	78°	53900									12
15	59°	78700	68°	73500	73°	61800	76°	49100	79°	37600							15
20	50°	39800	62°	41300	68°	42200	72°	42600	75°	33100	78°	28700					20
25	40°	24800	55°	26100	63°	26900	69°	27300	72°	27700	75°	25500	77°	22500			25
30	26°	16800	49°	18100	58°	18700	65°	19200	69°	19400	72°	19700	75°	19800	77°	17900	30
35			41°	13100	53°	13700	61°	14100	66°	14400	69°	14600	73°	14700	75°	14800	35
40			31°	9700	47°	10300	56°	10700	62°	10900	66°	11100	70°	11200	73°	11400	40
45			18°	7100	41°	7800	52°	8100	58°	8400	63°	8600	67°	8700	70°	8800	45
50					35°	5900	47°	6200	55°	6500	60°	6700	65°	6800	68°	6900	50
55					28°	4400	41°	4800	51°	5000	57°	5200	62°	5300	66°	5400	55
60					18°	3100	35°	3600	46°	3800	54°	4000	59°	4100	63°	4200	60
65							28°	2500	42°	2800	50°	3000	56°	3100	61°	3200	65
70							18°	1700	36°	2000	46°	2100	53°	2300	58°	2400	70
75									30°	1300	42°	1400	50°	1600	55°	1700	75
80											38°	800	46°	1000	52°	1100	80
85																	85
90																	90
95																	95
100																	100
105																	105
110																	110
115																	115
120																	120
125																	125
130																	130
DEDUCTIONS FOR MAIN BOOM CAPACITIES	0°	14100	0°	6300	0°	3050	0°	1250	0°	0	0°	0	0°	0	0°	0	
		1570		1140		920		770		660		580		520		460	STOWED
		3510		3240		3100		3010		2940		2890		2850		2820	RET
		3910		3530		3340		3200		3110		3040		2980		2940	EXT
	2620		2420		2320		2250		2200		2170		2140		2120	FIXED	

# CODE 45

## MAIN BOOM

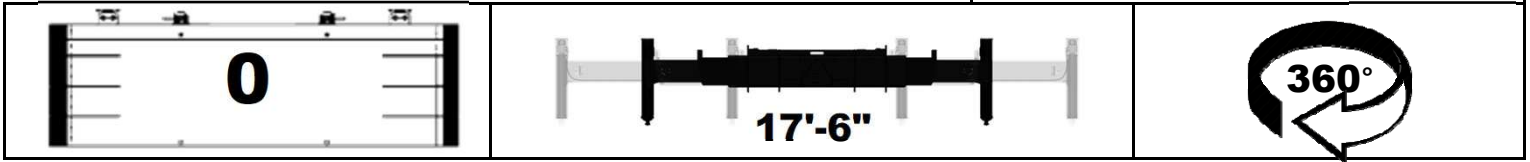

LOAD RADIUS (FT)	ANGLE	LIFTING CAP. (LBS)	ANGLE	LIFTING CAP. (LBS)	ANGLE	LIFTING CAP. (LBS)	ANGLE	LIFTING CAP. (LBS)	ANGLE	LIFTING CAP. (LBS)	ANGLE	LIFTING CAP. (LBS)	ANGLE	LIFTING CAP. (LBS)	ANGLE	LIFTING CAP. (LBS)	LOAD RADIUS (FT)
LENGTH	39.3 FT		53 FT		66 FT		79 FT		92 FT		105 FT		118 FT		131 FT		
6	74°	90000															6
8	70°	90000															8
10	67°	90000	74°	79200	77°	72400											10
12	64°	90000	71°	79200	76°	68300	78°	53900									12
15	59°	75500	68°	73500	73°	61800	76°	49100	79°	37600							15
20	50°	38000	62°	39600	68°	40400	72°	40900	75°	33100	78°	28700					20
25	40°	23600	55°	24900	63°	25600	69°	26100	72°	26400	75°	25500	77°	22500			25
30	26°	15900	49°	17100	58°	17800	65°	18200	69°	18500	72°	18700	75°	18900	77°	17900	30
35			41°	12300	53°	12900	61°	13300	66°	13600	69°	13800	73°	14000	75°	14100	35
40			31°	9000	47°	9600	56°	10000	62°	10300	66°	10500	70°	10600	73°	10700	40
45			18°	6600	41°	7200	52°	7600	58°	7900	63°	8000	67°	8200	70°	8300	45
50					35°	5400	47°	5800	55°	6000	60°	6200	65°	6300	68°	6400	50
55					28°	3900	41°	4300	51°	4600	57°	4800	62°	4900	66°	5000	55
60					18°	2700	35°	3200	46°	3400	54°	3600	59°	3700	63°	3800	60
65							28°	2200	42°	2500	50°	2600	56°	2800	61°	2900	65
70							18°	1400	36°	1600	46°	1800	53°	1900	58°	2000	70
75									30°	900	42°	1100	50°	1300	55°	1400	75
80															52°	800	80
85																	85
90																	90
95																	95
100																	100
105																	105
110																	110
115																	115
120																	120
125																	125
130																	130
DEDUCTIONS FOR MAIN BOOM CAPACITIES	0°	13250	0°	5800	0°	2650	0°	950	0°	0	0°	0	0°	0	0°	0	
		1570		1140		920		770		660		580		520		460	STOWED
		3510		3240		3100		3010		2940		2890		2850		2820	RET
		3910		3530		3340		3200		3110		3040		2980		2940	EXT
	2620		2420		2320		2250		2200		2170		2140		2120	FIXED	

# CODE 46

## MAIN BOOM



<p style="font-size: 2em; font-weight: bold;">10,000</p>	<p style="font-size: 1.5em; font-weight: bold;">17'-6"</p>	<p style="font-size: 1.5em; font-weight: bold;">REAR</p>
--	--	--

LOAD RADIUS (FT)	ANGLE	LIFTING CAP. (LBS)	ANGLE	LIFTING CAP. (LBS)	ANGLE	LIFTING CAP. (LBS)	ANGLE	LIFTING CAP. (LBS)	ANGLE	LIFTING CAP. (LBS)	ANGLE	LIFTING CAP. (LBS)	ANGLE	LIFTING CAP. (LBS)	ANGLE	LIFTING CAP. (LBS)	LOAD RADIUS (FT)
<b>LENGTH</b>		<b>39.3 FT</b>		<b>53 FT</b>		<b>66 FT</b>		<b>79 FT</b>		<b>92 FT</b>		<b>105 FT</b>		<b>118 FT</b>		<b>131 FT</b>	
6	74°	90000															6
8	70°	90000															8
10	67°	90000	74°	79200	77°	72400											10
12	64°	90000	71°	79200	76°	68300	78°	53900									12
15	59°	83200	68°	73500	73°	61800	76°	49100	79°	37600							15
20	50°	64800	62°	61700	68°	52500	72°	42600	75°	33100	78°	28700					20
25	40°	50300	55°	51200	63°	45500	69°	37100	72°	29100	75°	25500	77°	22500			25
30	26°	40400	49°	41400	58°	39800	65°	32900	69°	25700	72°	23100	75°	20500	77°	17900	30
35			41°	34200	53°	34800	61°	29300	66°	23200	69°	20700	73°	18600	75°	16600	35
40			31°	27100	47°	27800	56°	26100	62°	20700	66°	18700	70°	16900	73°	15200	40
45			18°	22000	41°	22700	52°	23100	58°	18700	63°	16900	67°	15300	70°	13900	45
50					35°	18800	47°	19200	55°	16900	60°	15300	65°	14000	68°	12700	50
55					28°	15900	41°	16300	51°	15400	57°	14000	62°	12800	66°	11900	55
60					18°	13400	35°	13900	46°	14000	54°	12700	59°	11900	63°	10900	60
65							28°	11900	42°	12200	50°	11900	56°	10900	61°	10000	65
70							18°	10300	36°	10500	46°	10700	53°	10000	58°	9200	70
75									30°	9200	42°	9300	50°	9200	55°	8500	75
80									23°	8000	38°	8200	46°	8300	52°	7800	80
85									11°	6900	33°	7100	43°	7300	49°	7200	85
90											27°	6200	39°	6400	46°	6500	90
95											19°	5400	34°	5600	43°	5700	95
100													29°	4900	39°	5000	100
105													23°	4200	36°	4300	105
110													14°	3600	31°	3700	110
115															26°	3200	115
120															19°	2700	120
125															6°	2300	125
130																	130
DEDUCTIONS FOR MAIN BOOM CAPACITIES	0°	30500	0°	18550	0°	13200	0°	8600	0°	6500	0°	4350	0°	3200	0°	0	
		1570		1140		920		770		660		580		520		460	STOWED
		3510		3240		3100		3010		2940		2890		2850		2820	RET
		3910		3530		3340		3200		3110		3040		2980		2940	EXT
	2620		2420		2320		2250		2200		2170		2140		2120	FIXED	



# CODE 47

## MAIN BOOM



LOAD RADIUS (FT)	ANGLE	LIFTING CAP. (LBS)	ANGLE	LIFTING CAP. (LBS)	ANGLE	LIFTING CAP. (LBS)	ANGLE	LIFTING CAP. (LBS)	ANGLE	LIFTING CAP. (LBS)	ANGLE	LIFTING CAP. (LBS)	ANGLE	LIFTING CAP. (LBS)	ANGLE	LIFTING CAP. (LBS)	LOAD RADIUS (FT)
LENGTH	39.3 FT		53 FT		66 FT		79 FT		92 FT		105 FT		118 FT		131 FT		
6	74°	90000															6
8	70°	90000															8
10	67°	90000	74°	79200	77°	72400											10
12	64°	90000	71°	79200	76°	68300	78°	53900									12
15	59°	83200	68°	73500	73°	61800	76°	49100	79°	37600							15
20	50°	64200	62°	61700	68°	52500	72°	42600	75°	33100	78°	28700					20
25	40°	49700	55°	50700	63°	45500	69°	37100	72°	29100	75°	25500	77°	22500			25
30	26°	39900	49°	41000	58°	39800	65°	32900	69°	25700	72°	23100	75°	20500	77°	17900	30
35			41°	33400	53°	34000	61°	29300	66°	23200	69°	20700	73°	18600	75°	16600	35
40			31°	26400	47°	27000	56°	26100	62°	20700	66°	18700	70°	16900	73°	15200	40
45			18°	21400	41°	22100	52°	22500	58°	18700	63°	16900	67°	15300	70°	13900	45
50					35°	18300	47°	18700	55°	16900	60°	15300	65°	14000	68°	12700	50
55					28°	15400	41°	15800	51°	15400	57°	14000	62°	12800	66°	11900	55
60					18°	13000	35°	13400	46°	13700	54°	12700	59°	11900	63°	10900	60
65							28°	11500	42°	11800	50°	11900	56°	10900	61°	10000	65
70							18°	9900	36°	10200	46°	10400	53°	10000	58°	9200	70
75									30°	8800	42°	9000	50°	9100	55°	8500	75
80									23°	7700	38°	7900	46°	8000	52°	7800	80
85									11°	6600	33°	6800	43°	7000	49°	7100	85
90											27°	5900	39°	6100	46°	6200	90
95											19°	5100	34°	5300	43°	5400	95
100													29°	4600	39°	4700	100
105													23°	4000	36°	4100	105
110													14°	3400	31°	3500	110
115															26°	3000	115
120															19°	2500	120
125															6°	2100	125
130																	130
DEDUCTIONS FOR MAIN BOOM CAPACITIES	0°	30300	0°	18250	0°	12800	0°	8450	0°	6250	0°	4300	0°	3100	0°	0	
		1570		1140		920		770		660		580		520		460	STOWED
		3510		3240		3100		3010		2940		2890		2850		2820	RET
		3910		3530		3340		3200		3110		3040		2980		2940	EXT
	2620		2420		2320		2250		2200		2170		2140		2120	FIXED	

# CODE 48

## MAIN BOOM



LOAD RADIUS (FT)	ANGLE	LIFTING CAP. (LBS)	ANGLE	LIFTING CAP. (LBS)	ANGLE	LIFTING CAP. (LBS)	ANGLE	LIFTING CAP. (LBS)	ANGLE	LIFTING CAP. (LBS)	ANGLE	LIFTING CAP. (LBS)	ANGLE	LIFTING CAP. (LBS)	ANGLE	LIFTING CAP. (LBS)	LOAD RADIUS (FT)
LENGTH	39.3 FT		53 FT		66 FT		79 FT		92 FT		105 FT		118 FT		131 FT		
6	74°	90000															6
8	70°	90000															8
10	67°	90000	74°	79200	77°	72400											10
12	64°	90000	71°	79200	76°	68300	78°	53900									12
15	59°	83200	68°	73500	73°	61800	76°	49100	79°	37600							15
20	50°	63500	62°	61700	68°	52500	72°	42600	75°	33100	78°	28700					20
25	40°	49200	55°	50200	63°	45500	69°	37100	72°	29100	75°	25500	77°	22500			25
30	26°	39500	49°	40500	58°	39800	65°	32900	69°	25700	72°	23100	75°	20500	77°	17900	30
35			41°	32500	53°	33200	61°	29300	66°	23200	69°	20700	73°	18600	75°	16600	35
40			31°	25700	47°	26300	56°	26100	62°	20700	66°	18700	70°	16900	73°	15200	40
45			18°	20800	41°	21500	52°	21800	58°	18700	63°	16900	67°	15300	70°	13900	45
50					35°	17800	47°	18200	55°	16900	60°	15300	65°	14000	68°	12700	50
55					28°	14900	41°	15300	51°	15400	57°	14000	62°	12800	66°	11900	55
60					18°	12500	35°	13000	46°	13300	54°	12700	59°	11900	63°	10900	60
65							28°	11100	42°	11400	50°	11600	56°	10900	61°	10000	65
70							18°	9500	36°	9800	46°	10000	53°	10000	58°	9200	70
75									30°	8500	42°	8700	50°	8800	55°	8500	75
80									23°	7300	38°	7500	46°	7700	52°	7800	80
85									11°	6300	33°	6600	43°	6700	49°	6800	85
90											27°	5700	39°	5800	46°	5900	90
95											19°	4900	34°	5100	43°	5200	95
100													29°	4400	39°	4500	100
105													23°	3800	36°	3900	105
110													14°	3200	31°	3300	110
115															26°	2800	115
120															19°	2400	120
125															6°	1900	125
130																	130
DEDUCTIONS FOR MAIN BOOM CAPACITIES	0°	30100	0°	17900	0°	12350	0°	8350	0°	6050	0°	4250	0°	3000	0°	0	
		1570		1140		920		770		660		580		520		460	STOWED
		3510		3240		3100		3010		2940		2890		2850		2820	RET
		3910		3530		3340		3200		3110		3040		2980		2940	EXT
	2620		2420		2320		2250		2200		2170		2140		2120	FIXED	

# CODE 49

## MAIN BOOM

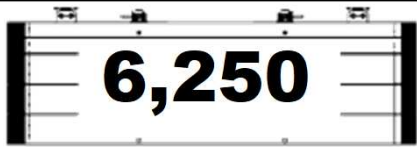

LOAD RADIUS (FT)	ANGLE	LIFTING CAP. (LBS)	ANGLE	LIFTING CAP. (LBS)	ANGLE	LIFTING CAP. (LBS)	ANGLE	LIFTING CAP. (LBS)	ANGLE	LIFTING CAP. (LBS)	ANGLE	LIFTING CAP. (LBS)	ANGLE	LIFTING CAP. (LBS)	ANGLE	LIFTING CAP. (LBS)	LOAD RADIUS (FT)
LENGTH	39.3 FT		53 FT		66 FT		79 FT		92 FT		105 FT		118 FT		131 FT		
6	74°	90000															6
8	70°	90000															8
10	67°	90000	74°	79200	77°	72400											10
12	64°	90000	71°	79200	76°	68300	78°	53900									12
15	59°	83200	68°	73500	73°	61800	76°	49100	79°	37600							15
20	50°	62900	62°	61700	68°	52500	72°	42600	75°	33100	78°	28700					20
25	40°	48700	55°	49700	63°	45500	69°	37100	72°	29100	75°	25500	77°	22500			25
30	26°	39000	49°	40100	58°	39800	65°	32900	69°	25700	72°	23100	75°	20500	77°	17900	30
35			41°	31600	53°	32300	61°	29300	66°	23200	69°	20700	73°	18600	75°	16600	35
40			31°	25000	47°	25600	56°	26000	62°	20700	66°	18700	70°	16900	73°	15200	40
45			18°	20200	41°	20800	52°	21200	58°	18700	63°	16900	67°	15300	70°	13900	45
50					35°	17300	47°	17600	55°	16900	60°	15300	65°	14000	68°	12700	50
55					28°	14400	41°	14800	51°	15100	57°	14000	62°	12800	66°	11900	55
60					18°	12100	35°	12600	46°	12900	54°	12700	59°	11900	63°	10900	60
65							28°	10700	42°	11000	50°	11200	56°	10900	61°	10000	65
70							18°	9200	36°	9500	46°	9700	53°	9800	58°	9200	70
75									30°	8200	42°	8400	50°	8500	55°	8500	75
80									23°	7000	38°	7200	46°	7400	52°	7500	80
85									11°	6000	33°	6300	43°	6400	49°	6500	85
90											27°	5400	39°	5600	46°	5700	90
95											19°	4700	34°	4800	43°	4900	95
100													29°	4100	39°	4200	100
105													23°	3500	36°	3700	105
110													14°	3000	31°	3100	110
115															26°	2600	115
120															19°	2200	120
125															6°	1700	125
130																	130
DEDUCTIONS FOR MAIN BOOM CAPACITIES	0°	29850	0°	17550	0°	11950	0°	8250	0°	5800	0°	4100	0°	2800	0°	0	
		1570		1140		920		770		660		580		520		460	STOWED
		3510		3240		3100		3010		2940		2890		2850		2820	RET
		3910		3530		3340		3200		3110		3040		2980		2940	EXT
		2620		2420		2320		2250		2200		2170		2140		2120	FIXED

# CODE 50

## MAIN BOOM



<p style="font-size: 2em; font-weight: bold; margin: 0;">5,000</p>	<p style="font-size: 1.5em; font-weight: bold; margin: 0;">17'-6"</p>	<p style="font-size: 1.5em; font-weight: bold; margin: 0;">REAR</p>
--	---	---

LOAD RADIUS (FT)	ANGLE	LIFTING CAP. (LBS)	ANGLE	LIFTING CAP. (LBS)	ANGLE	LIFTING CAP. (LBS)	ANGLE	LIFTING CAP. (LBS)	ANGLE	LIFTING CAP. (LBS)	ANGLE	LIFTING CAP. (LBS)	ANGLE	LIFTING CAP. (LBS)	ANGLE	LIFTING CAP. (LBS)	LOAD RADIUS (FT)
<b>LENGTH</b>		<b>39.3 FT</b>		<b>53 FT</b>		<b>66 FT</b>		<b>79 FT</b>		<b>92 FT</b>		<b>105 FT</b>		<b>118 FT</b>		<b>131 FT</b>	
6	74°	90000															6
8	70°	90000															8
10	67°	90000	74°	79200	77°	72400											10
12	64°	90000	71°	79200	76°	68300	78°	53900									12
15	59°	83200	68°	73500	73°	61800	76°	49100	79°	37600							15
20	50°	62300	62°	61700	68°	52500	72°	42600	75°	33100	78°	28700					20
25	40°	48200	55°	49200	63°	45500	69°	37100	72°	29100	75°	25500	77°	22500			25
30	26°	38600	49°	39600	58°	39800	65°	32900	69°	25700	72°	23100	75°	20500	77°	17900	30
35			41°	30800	53°	31500	61°	29300	66°	23200	69°	20700	73°	18600	75°	16600	35
40			31°	24300	47°	24900	56°	25300	62°	20700	66°	18700	70°	16900	73°	15200	40
45			18°	19600	41°	20200	52°	20600	58°	18700	63°	16900	67°	15300	70°	13900	45
50					35°	16700	47°	17100	55°	16900	60°	15300	65°	14000	68°	12700	50
55					28°	14000	41°	14400	51°	14600	57°	14000	62°	12800	66°	11900	55
60					18°	11700	35°	12200	46°	12400	54°	12600	59°	11900	63°	10900	60
65							28°	10400	42°	10600	50°	10800	56°	10900	61°	10000	65
70							18°	8800	36°	9100	46°	9300	53°	9400	58°	9200	70
75									30°	7800	42°	8000	50°	8200	55°	8300	75
80									23°	6700	38°	6900	46°	7100	52°	7200	80
85									11°	5800	33°	6000	43°	6100	49°	6200	85
90											27°	5100	39°	5300	46°	5400	90
95											19°	4400	34°	4600	43°	4700	95
100													29°	3900	39°	4000	100
105													23°	3300	36°	3400	105
110													14°	2800	31°	2900	110
115															26°	2400	115
120															19°	2000	120
125															6°	1500	125
130																	130
DEDUCTIONS FOR MAIN BOOM CAPACITIES	0°	29700	0°	17250	0°	11600	0°	8050	0°	5600	0°	3850	0°	2600	0°	0	
		1570		1140		920		770		660		580		520		460	STOWED
		3510		3240		3100		3010		2940		2890		2850		2820	RET
		3910		3530		3340		3200		3110		3040		2980		2940	EXT
	2620		2420		2320		2250		2200		2170		2140		2120	FIXED	

# CODE 51

## MAIN BOOM

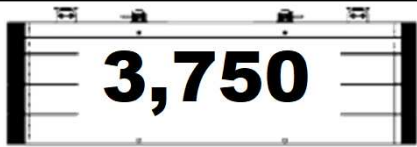

LOAD RADIUS (FT)	ANGLE	LIFTING CAP. (LBS)	ANGLE	LIFTING CAP. (LBS)	ANGLE	LIFTING CAP. (LBS)	ANGLE	LIFTING CAP. (LBS)	ANGLE	LIFTING CAP. (LBS)	ANGLE	LIFTING CAP. (LBS)	ANGLE	LIFTING CAP. (LBS)	ANGLE	LIFTING CAP. (LBS)	LOAD RADIUS (FT)
LENGTH	39.3 FT		53 FT		66 FT		79 FT		92 FT		105 FT		118 FT		131 FT		
6	74°	90000															6
8	70°	90000															8
10	67°	90000	74°	79200	77°	72400											10
12	64°	90000	71°	79200	76°	68300	78°	53900									12
15	59°	83200	68°	73500	73°	61800	76°	49100	79°	37600							15
20	50°	61600	62°	61700	68°	52500	72°	42600	75°	33100	78°	28700					20
25	40°	47700	55°	48600	63°	45500	69°	37100	72°	29100	75°	25500	77°	22500			25
30	26°	38100	49°	39200	58°	39700	65°	32900	69°	25700	72°	23100	75°	20500	77°	17900	30
35			41°	29900	53°	30600	61°	29300	66°	23200	69°	20700	73°	18600	75°	16600	35
40			31°	23600	47°	24200	56°	24600	62°	20700	66°	18700	70°	16900	73°	15200	40
45			18°	18900	41°	19600	52°	20000	58°	18700	63°	16900	67°	15300	70°	13900	45
50					35°	16200	47°	16600	55°	16800	60°	15300	65°	14000	68°	12700	50
55					28°	13500	41°	13900	51°	14200	57°	14000	62°	12800	66°	11900	55
60					18°	11300	35°	11700	46°	12000	54°	12200	59°	11900	63°	10900	60
65							28°	10000	42°	10200	50°	10400	56°	10600	61°	10000	65
70							18°	8500	36°	8800	46°	8900	53°	9100	58°	9200	70
75									30°	7500	42°	7700	50°	7800	55°	7900	75
80									23°	6400	38°	6600	46°	6800	52°	6900	80
85									11°	5500	33°	5700	43°	5800	49°	5900	85
90											27°	4900	39°	5000	46°	5100	90
95											19°	4100	34°	4300	43°	4400	95
100													29°	3700	39°	3800	100
105													23°	3100	36°	3200	105
110													14°	2500	31°	2700	110
115															26°	2200	115
120															19°	1800	120
125															6°	1400	125
130																	130
DEDUCTIONS FOR MAIN BOOM CAPACITIES	0°	29450	0°	16850	0°	11200	0°	7700	0°	5300	0°	3600	0°	2300	0°	0	
		1570		1140		920		770		660		580		520		460	STOWED
		3510		3240		3100		3010		2940		2890		2850		2820	RET
		3910		3530		3340		3200		3110		3040		2980		2940	EXT
	2620		2420		2320		2250		2200		2170		2140		2120	FIXED	

# CODE 52

## MAIN BOOM



**2,500**

**17'-6"**

**REAR**

LOAD RADIUS (FT)	ANGLE	LIFTING CAP. (LBS)	ANGLE	LIFTING CAP. (LBS)	ANGLE	LIFTING CAP. (LBS)	ANGLE	LIFTING CAP. (LBS)	ANGLE	LIFTING CAP. (LBS)	ANGLE	LIFTING CAP. (LBS)	ANGLE	LIFTING CAP. (LBS)	ANGLE	LIFTING CAP. (LBS)	LOAD RADIUS (FT)	
<b>LENGTH</b>		<b>39.3 FT</b>		<b>53 FT</b>		<b>66 FT</b>		<b>79 FT</b>		<b>92 FT</b>		<b>105 FT</b>		<b>118 FT</b>		<b>131 FT</b>		
6	74°	90000																6
8	70°	90000																8
10	67°	90000	74°	79200	77°	72400												10
12	64°	90000	71°	79200	76°	68300	78°	53900										12
15	59°	83200	68°	73500	73°	61800	76°	49100	79°	37600								15
20	50°	61000	62°	61700	68°	52500	72°	42600	75°	33100	78°	28700						20
25	40°	47100	55°	48100	63°	45500	69°	37100	72°	29100	75°	25500	77°	22500				25
30	26°	37100	49°	38400	58°	39100	65°	32900	69°	25700	72°	23100	75°	20500	77°	17900		30
35			41°	29100	53°	29700	61°	29300	66°	23200	69°	20700	73°	18600	75°	16600		35
40			31°	22800	47°	23500	56°	23900	62°	20700	66°	18700	70°	16900	73°	15200		40
45			18°	18300	41°	19000	52°	19400	58°	18700	63°	16900	67°	15300	70°	13900		45
50					35°	15700	47°	16000	55°	16300	60°	15300	65°	14000	68°	12700		50
55					28°	13000	41°	13400	51°	13700	57°	13900	62°	12800	66°	11900		55
60					18°	10800	35°	11300	46°	11600	54°	11800	59°	11900	63°	10900		60
65							28°	9600	42°	9900	50°	10000	56°	10200	61°	10000		65
70							18°	8100	36°	8400	46°	8600	53°	8700	58°	8800		70
75									30°	7200	42°	7400	50°	7500	55°	7600		75
80									23°	6100	38°	6300	46°	6500	52°	6600		80
85									11°	5200	33°	5400	43°	5600	49°	5700		85
90											27°	4600	39°	4800	46°	4900		90
95											19°	3900	34°	4100	43°	4200		95
100													29°	3400	39°	3500		100
105													23°	2900	36°	3000		105
110													14°	2300	31°	2500		110
115															26°	2000		115
120															19°	1600		120
125															6°	1200		125
130																		130
DEDUCTIONS FOR MAIN BOOM CAPACITIES	0°	29000	0°	16500	0°	10700	0°	7350	0°	5000	0°	3400	0°	2100	0°	0		
		1570		1140		920		770		660		580		520		460		STOWED
		3510		3240		3100		3010		2940		2890		2850		2820		RET
		3910		3530		3340		3200		3110		3040		2980		2940		EXT
	2620		2420		2320		2250		2200		2170		2140		2120			FIXED

# CODE 53

## MAIN BOOM



<p style="font-size: 2em; font-weight: bold; margin: 0;">1,250</p>	<p style="font-size: 1.5em; font-weight: bold; margin: 0;">17'-6"</p>	<p style="font-size: 1.5em; font-weight: bold; margin: 0;">REAR</p>
--	---	---

LOAD RADIUS (FT)	ANGLE	LIFTING CAP. (LBS)	ANGLE	LIFTING CAP. (LBS)	ANGLE	LIFTING CAP. (LBS)	ANGLE	LIFTING CAP. (LBS)	ANGLE	LIFTING CAP. (LBS)	ANGLE	LIFTING CAP. (LBS)	ANGLE	LIFTING CAP. (LBS)	ANGLE	LIFTING CAP. (LBS)	LOAD RADIUS (FT)
LENGTH	39.3 FT		53 FT		66 FT		79 FT		92 FT		105 FT		118 FT		131 FT		
6	74°	90000															6
8	70°	90000															8
10	67°	90000	74°	79200	77°	72400											10
12	64°	90000	71°	79200	76°	68300	78°	53900									12
15	59°	82700	68°	73500	73°	61800	76°	49100	79°	37600							15
20	50°	60300	62°	61300	68°	52500	72°	42600	75°	33100	78°	28700					20
25	40°	46600	55°	47600	63°	45500	69°	37100	72°	29100	75°	25500	77°	22500			25
30	26°	36000	49°	37400	58°	38000	65°	32900	69°	25700	72°	23100	75°	20500	77°	17900	30
35			41°	28200	53°	28900	61°	29300	66°	23200	69°	20700	73°	18600	75°	16600	35
40			31°	22100	47°	22800	56°	23200	62°	20700	66°	18700	70°	16900	73°	15200	40
45			18°	17700	41°	18400	52°	18800	58°	18700	63°	16900	67°	15300	70°	13900	45
50					35°	15100	47°	15500	55°	15800	60°	15300	65°	14000	68°	12700	50
55					28°	12500	41°	12900	51°	13200	57°	13400	62°	12800	66°	11900	55
60					18°	10400	35°	10900	46°	11100	54°	11300	59°	11500	63°	10900	60
65							28°	9200	42°	9500	50°	9700	56°	9800	61°	9900	65
70							18°	7800	36°	8100	46°	8200	53°	8400	58°	8500	70
75									30°	6900	42°	7000	50°	7200	55°	7300	75
80									23°	5800	38°	6000	46°	6200	52°	6300	80
85									11°	4900	33°	5100	43°	5300	49°	5400	85
90											27°	4300	39°	4500	46°	4600	90
95											19°	3600	34°	3800	43°	3900	95
100													29°	3200	39°	3300	100
105													23°	2600	36°	2800	105
110													14°	2100	31°	2300	110
115															26°	1800	115
120															19°	1400	120
125															6°	1000	125
130																	130
DEDUCTIONS FOR MAIN BOOM CAPACITIES	0°	28500	0°	16200	0°	10300	0°	7050	0°	4700	0°	3150	0°	1900	0°	0	
		1570		1140		920		770		660		580		520		460	STOWED
		3510		3240		3100		3010		2940		2890		2850		2820	RET
		3910		3530		3340		3200		3110		3040		2980		2940	EXT
	2620		2420		2320		2250		2200		2170		2140		2120	FIXED	

# CODE 54

## MAIN BOOM

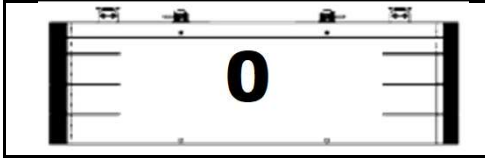

LOAD RADIUS (FT)	ANGLE	LIFTING CAP. (LBS)	ANGLE	LIFTING CAP. (LBS)	ANGLE	LIFTING CAP. (LBS)	ANGLE	LIFTING CAP. (LBS)	ANGLE	LIFTING CAP. (LBS)	ANGLE	LIFTING CAP. (LBS)	ANGLE	LIFTING CAP. (LBS)	ANGLE	LIFTING CAP. (LBS)	LOAD RADIUS (FT)
LENGTH	39.3 FT		53 FT		66 FT		79 FT		92 FT		105 FT		118 FT		131 FT		
6	74°	90000															6
8	70°	90000															8
10	67°	90000	74°	79200	77°	72400											10
12	64°	90000	71°	79200	76°	68300	78°	53900									12
15	59°	81800	68°	73500	73°	61800	76°	49100	79°	37600							15
20	50°	59700	62°	60600	68°	52500	72°	42600	75°	33100	78°	28700					20
25	40°	46100	55°	47100	63°	45500	69°	37100	72°	29100	75°	25500	77°	22500			25
30	26°	34900	49°	36300	58°	37000	65°	32900	69°	25700	72°	23100	75°	20500	77°	17900	30
35			41°	27400	53°	28000	61°	28500	66°	23200	69°	20700	73°	18600	75°	16600	35
40			31°	21400	47°	22100	56°	22500	62°	20700	66°	18700	70°	16900	73°	15200	40
45			18°	17100	41°	17800	52°	18200	58°	18500	63°	16900	67°	15300	70°	13900	45
50					35°	14600	47°	15000	55°	15200	60°	15300	65°	14000	68°	12700	50
55					28°	12100	41°	12500	51°	12700	57°	12900	62°	12800	66°	11900	55
60					18°	10000	35°	10500	46°	10700	54°	10900	59°	11000	63°	10900	60
65							28°	8800	42°	9100	50°	9300	56°	9400	61°	9500	65
70							18°	7400	36°	7700	46°	7900	53°	8000	58°	8100	70
75									30°	6500	42°	6700	50°	6900	55°	7000	75
80									23°	5500	38°	5700	46°	5900	52°	6000	80
85									11°	4600	33°	4900	43°	5000	49°	5100	85
90											27°	4100	39°	4200	46°	4300	90
95											19°	3400	34°	3600	43°	3700	95
100													29°	2900	39°	3100	100
105													23°	2400	36°	2500	105
110													14°	1900	31°	2000	110
115															26°	1600	115
120															19°	1200	120
125															6°	800	125
130																	130
DEDUCTIONS FOR MAIN BOOM CAPACITIES	0°	28050	0°	15750	0°	9900	0°	6700	0°	4400	0°	2900	0°	1700	0°	0	
		1570		1140		920		770		660		580		520		460	STOWED
		3510		3240		3100		3010		2940		2890		2850		2820	RET
		3910		3530		3340		3200		3110		3040		2980		2940	EXT
	2620		2420		2320		2250		2200		2170		2140		2120		FIXED



# CODE 55

## MAIN BOOM



**10,000**

**7'-10"**

**360°**

LOAD RADIUS (FT)	ANGLE	LIFTING CAP. (LBS)	ANGLE	LIFTING CAP. (LBS)	ANGLE	LIFTING CAP. (LBS)	ANGLE	LIFTING CAP. (LBS)	ANGLE	LIFTING CAP. (LBS)	ANGLE	LIFTING CAP. (LBS)	ANGLE	LIFTING CAP. (LBS)	ANGLE	LIFTING CAP. (LBS)	LOAD RADIUS (FT)
LENGTH	39.3 FT		53 FT		66 FT		79 FT		92 FT		105 FT		118 FT		131 FT		
6	74°	90000															6
8	70°	90000															8
10	67°	58000	74°	59600	77°	60500											10
12	64°	41400	71°	42800	76°	43600	78°	44100									12
15	59°	27900	68°	29000	73°	29700	76°	30200	79°	30500							15
20	50°	16500	62°	17500	68°	18100	72°	18500	75°	18800	78°	19000					20
25	40°	10400	55°	11500	63°	12000	69°	12300	72°	12600	75°	12800	77°	12900			25
30	26°	6700	49°	7700	58°	8200	65°	8600	69°	8800	72°	9000	75°	9100	77°	9200	30
35			41°	5100	53°	5700	61°	6000	66°	6200	69°	6400	73°	6500	75°	6600	35
40			31°	3300	47°	3800	56°	4100	62°	4300	66°	4500	70°	4600	73°	4700	40
45			18°	1800	41°	2400	52°	2700	58°	2900	63°	3100	67°	3200	70°	3300	45
50					35°	1300	47°	1600	55°	1800	60°	2000	65°	2100	68°	2200	50
55							41°	700	51°	900	57°	1100	62°	1200	66°	1300	55
60																	60
65																	65
70																	70
75																	75
80																	80
85																	85
90																	90
95																	95
100																	100
105																	105
110																	110
115																	115
120																	120
125																	125
130																	130
DEDUCTIONS FOR MAIN BOOM CAPACITIES	0°	5250	0°	1300	0°	0	0°	0	0°	0	0°	0	0°	0	0°	0	
		1570		1140		920		770		660		580		520		460	STOWED
		3510		3240		3100		3010		2940		2890		2850		2820	RET
		3910		3530		3340		3200		3110		3040		2980		2940	EXT
	2620		2420		2320		2250		2200		2170		2140		2120		FIXED

# CODE 56

## MAIN BOOM

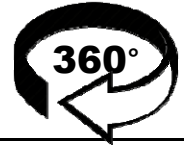

LOAD RADIUS (FT)	ANGLE	LIFTING CAP. (LBS)	ANGLE	LIFTING CAP. (LBS)	ANGLE	LIFTING CAP. (LBS)	ANGLE	LIFTING CAP. (LBS)	ANGLE	LIFTING CAP. (LBS)	ANGLE	LIFTING CAP. (LBS)	ANGLE	LIFTING CAP. (LBS)	ANGLE	LIFTING CAP. (LBS)	LOAD RADIUS (FT)
LENGTH	39.3 FT		53 FT		66 FT		79 FT		92 FT		105 FT		118 FT		131 FT		
6	74°	90000															6
8	70°	87000															8
10	67°	55400	74°	57000	77°	57900											10
12	64°	39500	71°	40900	76°	41700	78°	42200									12
15	59°	26500	68°	27700	73°	28300	76°	28800	79°	29100							15
20	50°	15500	62°	16600	68°	17100	72°	17500	75°	17800	78°	18000					20
25	40°	9700	55°	10700	63°	11300	69°	11600	72°	11900	75°	12000	77°	12200			25
30	26°	6100	49°	7100	58°	7600	65°	8000	69°	8200	72°	8400	75°	8500	77°	8600	30
35			41°	4600	53°	5200	61°	5500	66°	5700	69°	5900	73°	6000	75°	6100	35
40			31°	2800	47°	3400	56°	3700	62°	3900	66°	4100	70°	4200	73°	4300	40
45			18°	1400	41°	2000	52°	2300	58°	2600	63°	2700	67°	2800	70°	2900	45
50					35°	900	47°	1300	55°	1500	60°	1700	65°	1800	68°	1900	50
55											57°	800	62°	900	66°	1000	55
60																	60
65																	65
70																	70
75																	75
80																	80
85																	85
90																	90
95																	95
100																	100
105																	105
110																	110
115																	115
120																	120
125																	125
130																	130
DEDUCTIONS FOR MAIN BOOM CAPACITIES	0°	4700	0°	950	0°	0	0°	0	0°	0	0°	0	0°	0	0°	0	
		1570		1140		920		770		660		580		520		460	STOWED
		3510		3240		3100		3010		2940		2890		2850		2820	RET
		3910		3530		3340		3200		3110		3040		2980		2940	EXT
	2620		2420		2320		2250		2200		2170		2140		2120	FIXED	

# CODE 57

## MAIN BOOM



LOAD RADIUS (FT)	ANGLE	LIFTING CAP. (LBS)	ANGLE	LIFTING CAP. (LBS)	ANGLE	LIFTING CAP. (LBS)	ANGLE	LIFTING CAP. (LBS)	ANGLE	LIFTING CAP. (LBS)	ANGLE	LIFTING CAP. (LBS)	ANGLE	LIFTING CAP. (LBS)	ANGLE	LIFTING CAP. (LBS)	LOAD RADIUS (FT)
LENGTH	39.3 FT		53 FT		66 FT		79 FT		92 FT		105 FT		118 FT		131 FT		
6	74°	90000															6
8	70°	83200															8
10	67°	52900	74°	54500	77°	55400											10
12	64°	37600	71°	39000	76°	39800	78°	40300									12
15	59°	25100	68°	26300	73°	26900	76°	27400	79°	27700							15
20	50°	14600	62°	15600	68°	16200	72°	16600	75°	16800	78°	17000					20
25	40°	9000	55°	10000	63°	10500	69°	10900	72°	11100	75°	11300	77°	11500			25
30	26°	5500	49°	6500	58°	7000	65°	7400	69°	7600	72°	7800	75°	7900	77°	8000	30
35			41°	4200	53°	4700	61°	5000	66°	5200	69°	5400	73°	5500	75°	5600	35
40			31°	2400	47°	2900	56°	3300	62°	3500	66°	3700	70°	3800	73°	3900	40
45			18°	1100	41°	1600	52°	2000	58°	2200	63°	2300	67°	2500	70°	2600	45
50							47°	900	55°	1200	60°	1300	65°	1400	68°	1500	50
55																	55
60																	60
65																	65
70																	70
75																	75
80																	80
85																	85
90																	90
95																	95
100																	100
105																	105
110																	110
115																	115
120																	120
125																	125
130																	130
DEDUCTIONS FOR MAIN BOOM CAPACITIES	0°	4150	0°	650	0°	0	0°	0	0°	0	0°	0	0°	0	0°	0	
		1570		1140		920		770		660		580		520		460	STOWED
		3510		3240		3100		3010		2940		2890		2850		2820	RET
		3910		3530		3340		3200		3110		3040		2980		2940	EXT
	2620		2420		2320		2250		2200		2170		2140		2120	FIXED	

# CODE 58

## MAIN BOOM



LOAD RADIUS (FT)	ANGLE	LIFTING CAP. (LBS)	ANGLE	LIFTING CAP. (LBS)	ANGLE	LIFTING CAP. (LBS)	ANGLE	LIFTING CAP. (LBS)	ANGLE	LIFTING CAP. (LBS)	ANGLE	LIFTING CAP. (LBS)	ANGLE	LIFTING CAP. (LBS)	ANGLE	LIFTING CAP. (LBS)	LOAD RADIUS (FT)
LENGTH	39.3 FT		53 FT		66 FT		79 FT		92 FT		105 FT		118 FT		131 FT		
6	74°	90000															6
8	70°	79400															8
10	67°	50400	74°	52000	77°	52900											10
12	64°	35700	71°	37100	76°	37900	78°	38400									12
15	59°	23700	68°	24900	73°	25600	76°	26000	79°	26300							15
20	50°	13600	62°	14700	68°	15200	72°	15600	75°	15900	78°	16100					20
25	40°	8200	55°	9300	63°	9800	69°	10200	72°	10400	75°	10600	77°	10700			25
30	26°	4900	49°	5900	58°	6500	65°	6800	69°	7000	72°	7200	75°	7300	77°	7400	30
35			41°	3700	53°	4200	61°	4500	66°	4700	69°	4900	73°	5000	75°	5100	35
40			31°	2000	47°	2500	56°	2900	62°	3100	66°	3200	70°	3400	73°	3400	40
45					41°	1300	52°	1600	58°	1800	63°	2000	67°	2100	70°	2200	45
50									55°	800	60°	1000	65°	1100	68°	1200	50
55																	55
60																	60
65																	65
70																	70
75																	75
80																	80
85																	85
90																	90
95																	95
100																	100
105																	105
110																	110
115																	115
120																	120
125																	125
130																	130
DEDUCTIONS FOR MAIN BOOM CAPACITIES	0°	3650	0°	0	0°	0	0°	0	0°	0	0°	0	0°	0	0°	0	
		1570		1140		920		770		660		580		520		460	STOWED
		3510		3240		3100		3010		2940		2890		2850		2820	RET
		3910		3530		3340		3200		3110		3040		2980		2940	EXT
	2620		2420		2320		2250		2200		2170		2140		2120	FIXED	

# CODE 59

## MAIN BOOM



LOAD RADIUS (FT)	ANGLE	LIFTING CAP. (LBS)	ANGLE	LIFTING CAP. (LBS)	ANGLE	LIFTING CAP. (LBS)	ANGLE	LIFTING CAP. (LBS)	ANGLE	LIFTING CAP. (LBS)	ANGLE	LIFTING CAP. (LBS)	ANGLE	LIFTING CAP. (LBS)	ANGLE	LIFTING CAP. (LBS)	LOAD RADIUS (FT)
LENGTH	39.3 FT		53 FT		66 FT		79 FT		92 FT		105 FT		118 FT		131 FT		
6	74°	90000															6
8	70°	75700															8
10	67°	47900	74°	49500	77°	50400											10
12	64°	33800	71°	35200	76°	36000	78°	36500									12
15	59°	22300	68°	23500	73°	24200	76°	24600	79°	24900							15
20	50°	12600	62°	13700	68°	14300	72°	14700	75°	14900	78°	15100					20
25	40°	7500	55°	8500	63°	9100	69°	9400	72°	9700	75°	9900	77°	10000			25
30	26°	4300	49°	5300	58°	5900	65°	6200	69°	6400	72°	6600	75°	6700	77°	6900	30
35			41°	3200	53°	3700	61°	4000	66°	4200	69°	4400	73°	4500	75°	4600	35
40			31°	1600	47°	2100	56°	2400	62°	2700	66°	2800	70°	2900	73°	3000	40
45					41°	900	52°	1200	58°	1400	63°	1600	67°	1700	70°	1800	45
50													65°	800	68°	900	50
55																	55
60																	60
65																	65
70																	70
75																	75
80																	80
85																	85
90																	90
95																	95
100																	100
105																	105
110																	110
115																	115
120																	120
125																	125
130																	130
DEDUCTIONS FOR MAIN BOOM CAPACITIES	0°	3100	0°	0	0°	0	0°	0	0°	0	0°	0	0°	0	0°	0	
		1570		1140		920		770		660		580		520		460	STOWED
		3510		3240		3100		3010		2940		2890		2850		2820	RET
		3910		3530		3340		3200		3110		3040		2980		2940	EXT
	2620		2420		2320		2250		2200		2170		2140		2120	FIXED	

# CODE 60

## MAIN BOOM

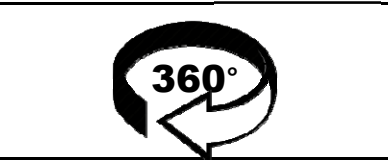
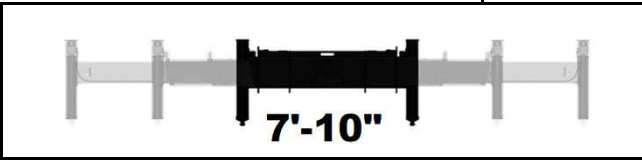

LOAD RADIUS (FT)	ANGLE	LIFTING CAP. (LBS)	ANGLE	LIFTING CAP. (LBS)	ANGLE	LIFTING CAP. (LBS)	ANGLE	LIFTING CAP. (LBS)	ANGLE	LIFTING CAP. (LBS)	ANGLE	LIFTING CAP. (LBS)	ANGLE	LIFTING CAP. (LBS)	ANGLE	LIFTING CAP. (LBS)	LOAD RADIUS (FT)
LENGTH	39.3 FT		53 FT		66 FT		79 FT		92 FT		105 FT		118 FT		131 FT		
6	74°	90000															6
8	70°	71900															8
10	67°	45300	74°	46900	77°	47800											10
12	64°	31900	71°	33300	76°	34100	78°	34600									12
15	59°	20900	68°	22100	73°	22800	76°	23200	79°	23600							15
20	50°	11700	62°	12800	68°	13300	72°	13700	75°	14000	78°	14200					20
25	40°	6800	55°	7800	63°	8400	69°	8700	72°	9000	75°	9100	77°	9300			25
30	26°	3700	49°	4800	58°	5300	65°	5600	69°	5900	72°	6000	75°	6200	77°	6300	30
35			41°	2700	53°	3200	61°	3500	66°	3800	69°	3900	73°	4000	75°	4100	35
40			31°	1100	47°	1700	56°	2000	62°	2200	66°	2400	70°	2500	73°	2600	40
45							52°	900	58°	1100	63°	1200	67°	1300	70°	1400	45
50																	50
55																	55
60																	60
65																	65
70																	70
75																	75
80																	80
85																	85
90																	90
95																	95
100																	100
105																	105
110																	110
115																	115
120																	120
125																	125
130																	130
DEDUCTIONS FOR MAIN BOOM CAPACITIES	0°	2550	0°	0	0°	0	0°	0	0°	0	0°	0	0°	0	0°	0	
		1570		1140		920		770		660		580		520		460	STOWED
		3510		3240		3100		3010		2940		2890		2850		2820	RET
		3910		3530		3340		3200		3110		3040		2980		2940	EXT
	2620		2420		2320		2250		2200		2170		2140		2120	FIXED	

# CODE 61

## MAIN BOOM



LOAD RADIUS (FT)	ANGLE	LIFTING CAP. (LBS)	ANGLE	LIFTING CAP. (LBS)	ANGLE	LIFTING CAP. (LBS)	ANGLE	LIFTING CAP. (LBS)	ANGLE	LIFTING CAP. (LBS)	ANGLE	LIFTING CAP. (LBS)	ANGLE	LIFTING CAP. (LBS)	ANGLE	LIFTING CAP. (LBS)	LOAD RADIUS (FT)
LENGTH	39.3 FT		53 FT		66 FT		79 FT		92 FT		105 FT		118 FT		131 FT		
6	74°	90000															6
8	70°	68100															8
10	67°	42800	74°	44400	77°	45300											10
12	64°	30000	71°	31400	76°	32200	78°	32700									12
15	59°	19500	68°	20700	73°	21400	76°	21800	79°	22200							15
20	50°	10700	62°	11800	68°	12400	72°	12800	75°	13000	78°	13200					20
25	40°	6100	55°	7100	63°	7600	69°	8000	72°	8200	75°	8400	77°	8600			25
30	26°	3100	49°	4200	58°	4700	65°	5000	69°	5300	72°	5400	75°	5600	77°	5700	30
35			41°	2200	53°	2700	61°	3000	66°	3300	69°	3400	73°	3500	75°	3600	35
40			31°	700	47°	1300	56°	1600	62°	1800	66°	2000	70°	2100	73°	2200	40
45											63°	900	67°	1000	70°	1100	45
50																	50
55																	55
60																	60
65																	65
70																	70
75																	75
80																	80
85																	85
90																	90
95																	95
100																	100
105																	105
110																	110
115																	115
120																	120
125																	125
130																	130
DEDUCTIONS FOR MAIN BOOM CAPACITIES	0°	2000	0°	0	0°	0	0°	0	0°	0	0°	0	0°	0	0°	0	
		1570		1140		920		770		660		580		520		460	STOWED
		3510		3240		3100		3010		2940		2890		2850		2820	RET
		3910		3530		3340		3200		3110		3040		2980		2940	EXT
	2620		2420		2320		2250		2200		2170		2140		2120	FIXED	

# CODE 62

## MAIN BOOM

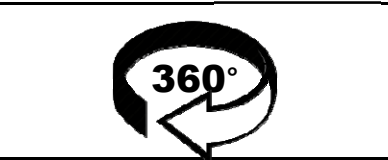
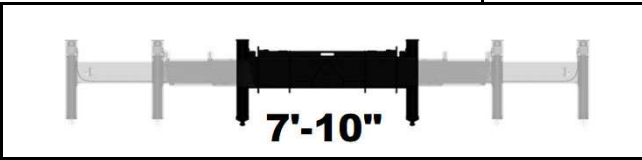

LOAD RADIUS (FT)	ANGLE	LIFTING CAP. (LBS)	ANGLE	LIFTING CAP. (LBS)	ANGLE	LIFTING CAP. (LBS)	ANGLE	LIFTING CAP. (LBS)	ANGLE	LIFTING CAP. (LBS)	ANGLE	LIFTING CAP. (LBS)	ANGLE	LIFTING CAP. (LBS)	ANGLE	LIFTING CAP. (LBS)	LOAD RADIUS (FT)
LENGTH	39.3 FT		53 FT		66 FT		79 FT		92 FT		105 FT		118 FT		131 FT		
6	74°	90000															6
8	70°	64300															8
10	67°	40300	74°	41900	77°	42800											10
12	64°	28100	71°	29500	76°	30300	78°	30800									12
15	59°	18200	68°	19400	73°	20000	76°	20500	79°	20800							15
20	50°	9800	62°	10800	68°	11400	72°	11800	75°	12100	78°	12300					20
25	40°	5300	55°	6400	63°	6900	69°	7300	72°	7500	75°	7700	77°	7800			25
30	26°	2500	49°	3600	58°	4100	65°	4400	69°	4700	72°	4900	75°	5000	77°	5100	30
35			41°	1700	53°	2200	61°	2500	66°	2800	69°	2900	73°	3000	75°	3100	35
40					47°	800	56°	1200	62°	1400	66°	1500	70°	1700	73°	1800	40
45																	45
50																	50
55																	55
60																	60
65																	65
70																	70
75																	75
80																	80
85																	85
90																	90
95																	95
100																	100
105																	105
110																	110
115																	115
120																	120
125																	125
130																	130
DEDUCTIONS FOR MAIN BOOM CAPACITIES	0°	1450	0°	0	0°	0	0°	0	0°	0	0°	0	0°	0	0°	0	
		1570		1140		920		770		660		580		520		460	STOWED
		3510		3240		3100		3010		2940		2890		2850		2820	RET
		3910		3530		3340		3200		3110		3040		2980		2940	EXT
	2620		2420		2320		2250		2200		2170		2140		2120	FIXED	



# CODE 63

## MAIN BOOM

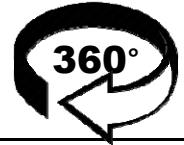
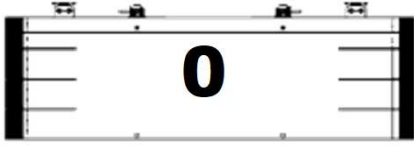

LOAD RADIUS (FT)	ANGLE	LIFTING CAP. (LBS)	ANGLE	LIFTING CAP. (LBS)	ANGLE	LIFTING CAP. (LBS)	ANGLE	LIFTING CAP. (LBS)	ANGLE	LIFTING CAP. (LBS)	ANGLE	LIFTING CAP. (LBS)	ANGLE	LIFTING CAP. (LBS)	ANGLE	LIFTING CAP. (LBS)	LOAD RADIUS (FT)
LENGTH	39.3 FT		53 FT		66 FT		79 FT		92 FT		105 FT		118 FT		131 FT		
6	74°	9000															6
8	70°	60600															8
10	67°	37700	74°	39300	77°	40300											10
12	64°	26200	71°	27600	76°	28400	78°	28900									12
15	59°	16800	68°	18000	73°	18600	76°	19100	79°	19400							15
20	50°	8800	62°	9900	68°	10500	72°	10800	75°	11100	78°	11300					20
25	40°	4600	55°	5600	63°	6200	69°	6500	72°	6800	75°	7000	77°	7100			25
30	26°	2000	49°	3000	58°	3500	65°	3900	69°	4100	72°	4300	75°	4400	77°	4500	30
35			41°	1200	53°	1700	61°	2000	66°	2300	69°	2400	73°	2600	75°	2700	35
40							56°	700	62°	900	66°	1100	70°	1200	73°	1300	40
45																	45
50																	50
55																	55
60																	60
65																	65
70																	70
75																	75
80																	80
85																	85
90																	90
95																	95
100																	100
105																	105
110																	110
115																	115
120																	120
125																	125
130																	130
DEDUCTIONS FOR MAIN BOOM CAPACITIES	0°	950	0°	0	0°	0	0°	0	0°	0	0°	0	0°	0	0°	0	
		1570		1140		920		770		660		580		520		460	STOWED
		3510		3240		3100		3010		2940		2890		2850		2820	RET
		3910		3530		3340		3200		3110		3040		2980		2940	EXT
	2620		2420		2320		2250		2200		2170		2140		2120	FIXED	

**CODES 64, 73, 82, 91,  
100, 109**  
**RETRACTED 30' JIB**

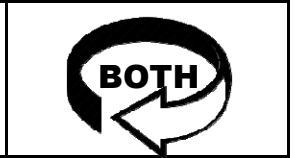
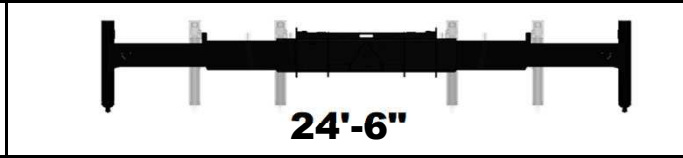
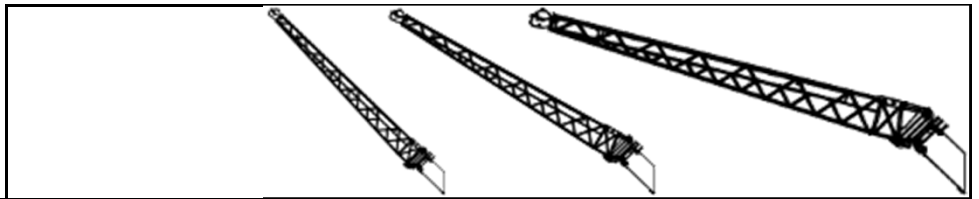

LOAD RADIUS (FT)	0° OFFSET				15° OFFSET			30° OFFSET			LOAD RADIUS (FT)
	BOOM ANGLE (DEG)	CODE 91	CODE 64	BOOM ANGLE (DEG)	CODE 100	CODE 73	BOOM ANGLE (DEG)	CODE 109	CODE 82		
		OVER REAR (LBS)	FULL 360° (LBS)		OVER REAR (LBS)	FULL 360° (LBS)		OVER REAR (LBS)	FULL 360° (LBS)		
6										6	
8										8	
10										10	
12										12	
15										15	
20										20	
25										25	
30										30	
35	79°	9000	9000							35	
40	77°	9000	9000	79°	9000	9000				40	
45	75°	9000	9000	78°	8580	8580				45	
50	74°	9000	9000	76°	8130	8130	79°	7680	7680	50	
55	72°	8560	8560	74°	7680	7680	77°	7270	7270	55	
60	70°	8100	8100	73°	7260	7260	75°	6890	6890	60	
65	68°	7680	7680	71°	6870	6870	73°	6540	6540	65	
70	66°	7240	7240	69°	6510	6510	71°	6210	6210	70	
75	64°	6840	6840	67°	6180	6180	69°	5910	5910	75	
80	62°	6260	6260	65°	5850	5850	67°	5630	5630	80	
85	60°	5730	5730	63°	5550	5550	65°	5360	5360	85	
90	58°	5220	5220	61°	5090	5090	63°	5100	5100	90	
95	55°	4750	4750	58°	4630	4630	60°	4850	4850	95	
100	53°	4320	4280	56°	4190	4190	58°	4410	4410	100	
105	50°	3900	3660	53°	3800	3800	55°	3990	3990	105	
110	48°	3520	3110	50°	3430	3430	52°	3600	3600	110	
115	45°	3170	2620	48°	3080	2920	49°	3230	3150	115	
120	42°	2830	2170	45°	2760	2440	46°	2880	2630	120	
125	39°	2520	1750	42°	2450	2000	43°	2550	2160	125	
130	36°	2240	1380	38°	2160	1590	39°	2240	1730	130	
135	32°	1970	1030	34°	1880	1220	35°	1950	1320	135	
140	28°	1720		30°	1620	860	30°	1670	930	140	
145										145	
150										150	

**CODES 65, 74, 83, 92,  
101, 110**  
**RETRACTED 30' JIB**

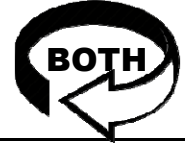
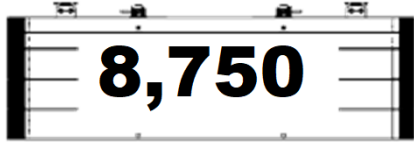
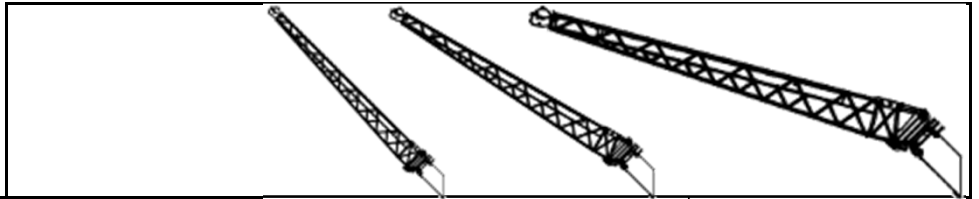

LOAD RADIUS (FT)	0° OFFSET			15° OFFSET			30° OFFSET			LOAD RADIUS (FT)
	BOOM ANGLE (DEG)	CODE 92	CODE 65	BOOM ANGLE (DEG)	CODE 101	CODE 74	BOOM ANGLE (DEG)	CODE 110	CODE 83	
		OVER REAR (LBS)	FULL 360° (LBS)		OVER REAR (LBS)	FULL 360° (LBS)		OVER REAR (LBS)	FULL 360° (LBS)	
6										6
8										8
10										10
12										12
15										15
20										20
25										25
30										30
35	79°	9000	9000							35
40	77°	9000	9000	79°	9000	9000				40
45	75°	9000	9000	78°	8580	8580				45
50	74°	9000	9000	76°	8130	8130	79°	7680	7680	50
55	72°	8560	8560	74°	7680	7680	77°	7270	7270	55
60	70°	8100	8100	73°	7260	7260	75°	6890	6890	60
65	68°	7680	7680	71°	6870	6870	73°	6540	6540	65
70	66°	7240	7240	69°	6510	6510	71°	6210	6210	70
75	64°	6840	6840	67°	6180	6180	69°	5910	5910	75
80	62°	6260	6260	65°	5850	5850	67°	5630	5630	80
85	60°	5730	5730	63°	5550	5550	65°	5360	5360	85
90	58°	5220	5220	61°	5090	5090	63°	5100	5100	90
95	55°	4750	4660	58°	4630	4630	60°	4850	4850	95
100	53°	4320	3990	56°	4190	4190	58°	4410	4410	100
105	50°	3900	3390	53°	3800	3770	55°	3990	3990	105
110	48°	3520	2860	50°	3430	3200	52°	3600	3450	110
115	45°	3170	2370	48°	3080	2680	49°	3230	2900	115
120	42°	2830	1930	45°	2760	2210	46°	2880	2400	120
125	39°	2520	1530	42°	2450	1780	43°	2550	1940	125
130	36°	2240	1170	38°	2160	1380	39°	2240	1510	130
135	32°	1960		34°	1880	1010	35°	1950	1120	135
140	28°	1610		30°	1620		30°	1670		140
145										145
150										150

**CODES 66, 75, 84, 93,  
102, 111**  
**RETRACTED 30' JIB**

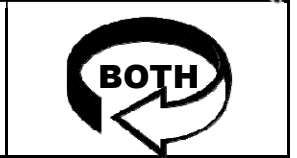
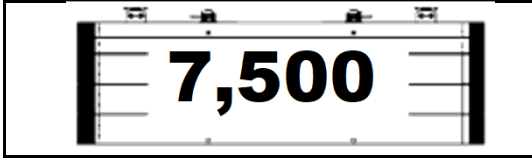
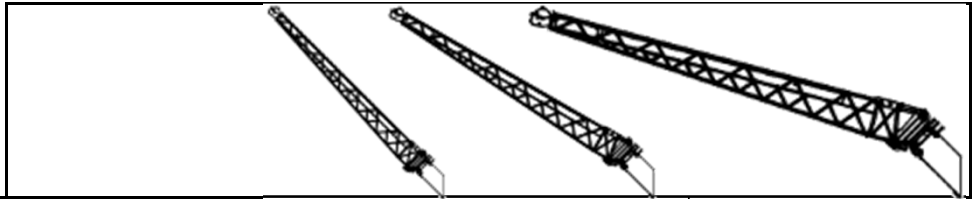

LOAD RADIUS (FT)	0° OFFSET			15° OFFSET			30° OFFSET			LOAD RADIUS (FT)
	BOOM ANGLE (DEG)	CODE 93	CODE 66	BOOM ANGLE (DEG)	CODE 102	CODE 75	BOOM ANGLE (DEG)	CODE 111	CODE 84	
		OVER REAR (LBS)	FULL 360° (LBS)		OVER REAR (LBS)	FULL 360° (LBS)		OVER REAR (LBS)	FULL 360° (LBS)	
6										6
8										8
10										10
12										12
15										15
20										20
25										25
30										30
35	79°	9000	9000							35
40	77°	9000	9000	79°	9000	9000				40
45	75°	9000	9000	78°	8580	8580				45
50	74°	9000	9000	76°	8130	8130	79°	7680	7680	50
55	72°	8560	8560	74°	7680	7680	77°	7270	7270	55
60	70°	8100	8100	73°	7260	7260	75°	6890	6890	60
65	68°	7680	7680	71°	6870	6870	73°	6540	6540	65
70	66°	7240	7240	69°	6510	6510	71°	6210	6210	70
75	64°	6840	6840	67°	6180	6180	69°	5910	5910	75
80	62°	6260	6260	65°	5850	5850	67°	5630	5630	80
85	60°	5730	5730	63°	5550	5550	65°	5360	5360	85
90	58°	5220	5090	61°	5090	5090	63°	5100	5100	90
95	55°	4750	4360	58°	4630	4630	60°	4850	4850	95
100	53°	4320	3710	56°	4190	4120	58°	4410	4410	100
105	50°	3900	3130	53°	3800	3500	55°	3990	3790	105
110	48°	3520	2600	50°	3430	2940	52°	3600	3200	110
115	45°	3170	2130	48°	3080	2440	49°	3230	2660	115
120	42°	2830	1700	45°	2760	1980	46°	2880	2170	120
125	39°	2520	1310	42°	2450	1560	43°	2550	1720	125
130	36°	2150	950	38°	2160	1170	39°	2240	1300	130
135	32°	1780		34°	1880		35°	1950	910	135
140	28°	1440		30°	1590		30°	1660		140
145										145
150										150

**CODES 67, 76, 85, 94,  
103, 112**  
**RETRACTED 30' JIB**

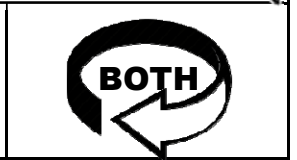
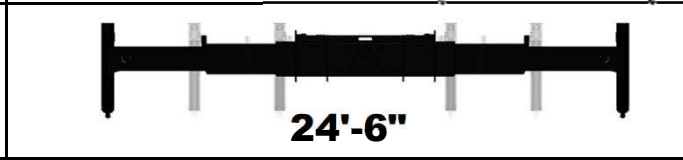
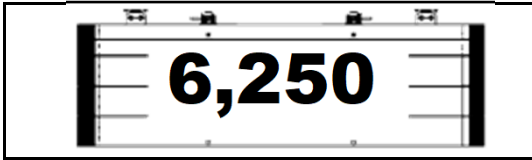
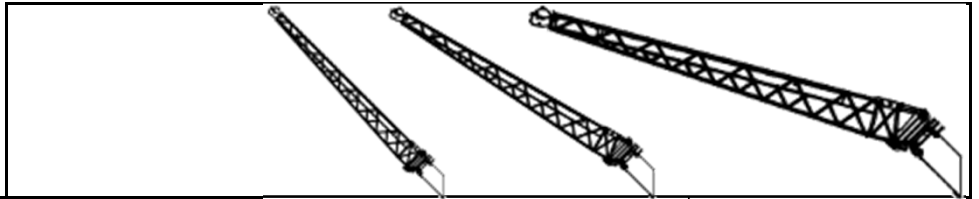

LOAD RADIUS (FT)	0° OFFSET			15° OFFSET			30° OFFSET			LOAD RADIUS (FT)
	BOOM ANGLE (DEG)	CODE 94	CODE 67	BOOM ANGLE (DEG)	CODE 103	CODE 76	BOOM ANGLE (DEG)	CODE 112	CODE 85	
		OVER REAR (LBS)	FULL 360° (LBS)		OVER REAR (LBS)	FULL 360° (LBS)		OVER REAR (LBS)	FULL 360° (LBS)	
6										6
8										8
10										10
12										12
15										15
20										20
25										25
30										30
35	79°	9000	9000							35
40	77°	9000	9000	79°	9000	9000				40
45	75°	9000	9000	78°	8580	8580				45
50	74°	9000	9000	76°	8130	8130	79°	7680	7680	50
55	72°	8560	8560	74°	7680	7680	77°	7270	7270	55
60	70°	8100	8100	73°	7260	7260	75°	6890	6890	60
65	68°	7680	7680	71°	6870	6870	73°	6540	6540	65
70	66°	7240	7240	69°	6510	6510	71°	6210	6210	70
75	64°	6840	6840	67°	6180	6180	69°	5910	5910	75
80	62°	6260	6260	65°	5850	5850	67°	5630	5630	80
85	60°	5730	5590	63°	5550	5550	65°	5360	5360	85
90	58°	5220	4770	61°	5090	5090	63°	5100	5100	90
95	55°	4750	4060	58°	4630	4510	60°	4850	4850	95
100	53°	4320	3420	56°	4190	3830	58°	4410	4160	100
105	50°	3900	2860	53°	3800	3230	55°	3990	3520	105
110	48°	3520	2350	50°	3430	2690	52°	3600	2940	110
115	45°	3170	1890	48°	3080	2190	49°	3230	2420	115
120	42°	2790	1470	45°	2760	1750	46°	2880	1940	120
125	39°	2360	1090	42°	2450	1330	43°	2550	1500	125
130	36°	1960		38°	2160	960	39°	2240	1090	130
135	32°	1600		34°	1780		35°	1880		135
140	28°	1260		30°	1410		30°	1480		140
145										145
150										150

**CODES 68, 77, 86, 95,  
104, 113**  
**RETRACTED 30' JIB**

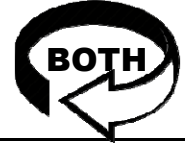
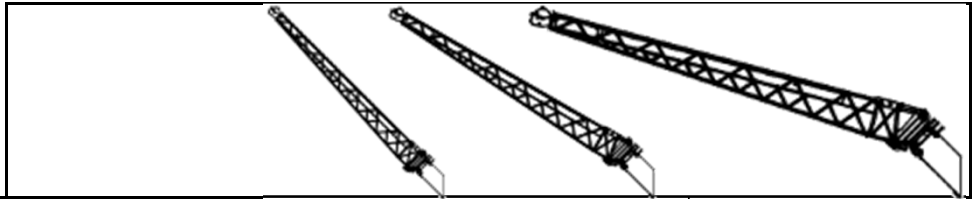

LOAD RADIUS (FT)	0° OFFSET			15° OFFSET			30° OFFSET			LOAD RADIUS (FT)
	BOOM ANGLE (DEG)	CODE 95	CODE 68	BOOM ANGLE (DEG)	CODE 104	CODE 77	BOOM ANGLE (DEG)	CODE 113	CODE 86	
		OVER REAR (LBS)	FULL 360° (LBS)		OVER REAR (LBS)	FULL 360° (LBS)		OVER REAR (LBS)	FULL 360° (LBS)	
6										6
8										8
10										10
12										12
15										15
20										20
25										25
30										30
35	79°	9000	9000							35
40	77°	9000	9000	79°	9000	9000				40
45	75°	9000	9000	78°	8580	8580				45
50	74°	9000	9000	76°	8130	8130	79°	7680	7680	50
55	72°	8560	8560	74°	7680	7680	77°	7270	7270	55
60	70°	8100	8100	73°	7260	7260	75°	6890	6890	60
65	68°	7680	7680	71°	6870	6870	73°	6540	6540	65
70	66°	7240	7240	69°	6510	6510	71°	6210	6210	70
75	64°	6840	6840	67°	6180	6180	69°	5910	5910	75
80	62°	6260	6150	65°	5850	5850	67°	5630	5630	80
85	60°	5730	5240	63°	5550	5550	65°	5360	5360	85
90	58°	5220	4450	61°	5090	4950	63°	5100	5100	90
95	55°	4750	3750	58°	4630	4200	60°	4850	4570	95
100	53°	4320	3140	56°	4190	3550	58°	4410	3870	100
105	50°	3900	2590	53°	3800	2960	55°	3990	3250	105
110	48°	3520	2090	50°	3430	2430	52°	3600	2690	110
115	45°	3040	1650	48°	3080	1950	49°	3230	2170	115
120	42°	2580	1240	45°	2760	1510	46°	2880	1710	120
125	39°	2160	870	42°	2400	1110	43°	2550	1280	125
130	36°	1770		38°	1980		39°	2110	880	130
135	32°	1420		34°	1600		35°	1700		135
140	28°	1090		30°	1240		30°	1310		140
145										145
150										150

**CODES 69, 78, 87, 96,  
105, 114  
RETRACTED 30' JIB**

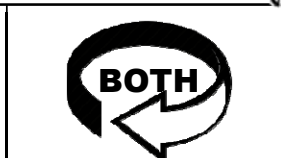
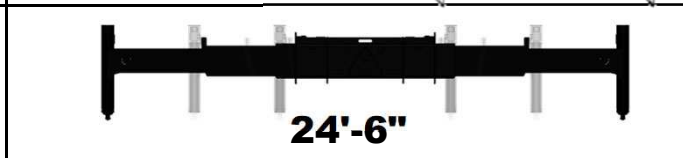
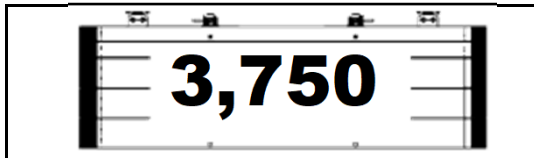
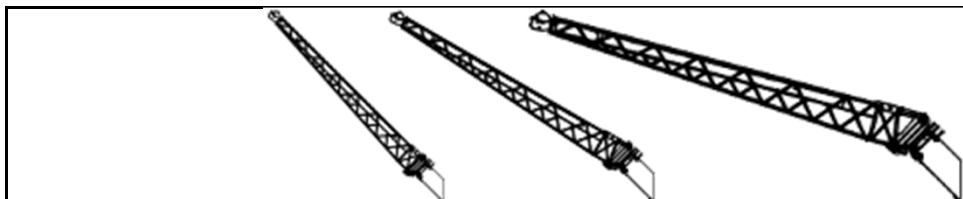

LOAD RADIUS (FT)	0° OFFSET			15° OFFSET			30° OFFSET			LOAD RADIUS (FT)
	BOOM ANGLE (DEG)	CODE 96	CODE 69	BOOM ANGLE (DEG)	CODE 105	CODE 78	BOOM ANGLE (DEG)	CODE 114	CODE 87	
		OVER REAR (LBS)	FULL 360° (LBS)		OVER REAR (LBS)	FULL 360° (LBS)		OVER REAR (LBS)	FULL 360° (LBS)	
6										6
8										8
10										10
12										12
15										15
20										20
25										25
30										30
35	79°	9000	9000							35
40	77°	9000	9000	79°	9000	9000				40
45	75°	9000	9000	78°	8580	8580				45
50	74°	9000	9000	76°	8130	8130	79°	7680	7680	50
55	72°	8560	8560	74°	7680	7680	77°	7270	7270	55
60	70°	8100	8100	73°	7260	7260	75°	6890	6890	60
65	68°	7680	7680	71°	6870	6870	73°	6540	6540	65
70	66°	7240	7240	69°	6510	6510	71°	6210	6210	70
75	64°	6840	6810	67°	6180	6180	69°	5910	5910	75
80	62°	6260	5780	65°	5850	5850	67°	5630	5630	80
85	60°	5730	4900	63°	5550	5440	65°	5360	5360	85
90	58°	5220	4130	61°	5090	4620	63°	5100	5030	90
95	55°	4750	3450	58°	4630	3900	60°	4850	4270	95
100	53°	4320	2850	56°	4190	3260	58°	4410	3590	100
105	50°	3870	2320	53°	3800	2690	55°	3990	2980	105
110	48°	3320	1840	50°	3430	2170	52°	3600	2430	110
115	45°	2830	1400	48°	3080	1710	49°	3230	1930	115
120	42°	2380	1010	45°	2640	1280	46°	2830	1470	120
125	39°	1960		42°	2200	890	43°	2360	1050	125
130	36°	1590		38°	1800		39°	1930		130
135	32°	1240		34°	1420		35°	1520		135
140	28°	910		30°	1070		30°	1130		140
145										145
150										150

**CODES 70, 79, 88, 97,  
106, 115  
RETRACTED 30' JIB**

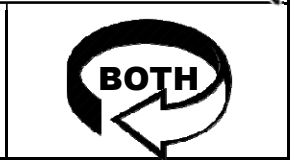
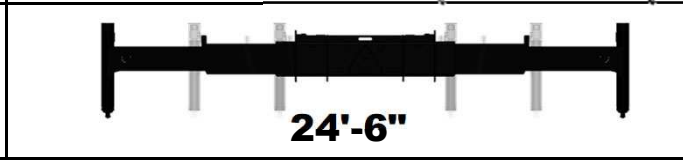
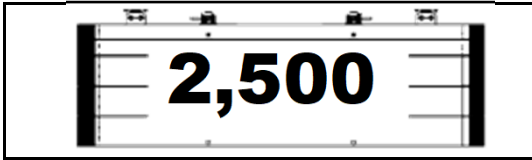
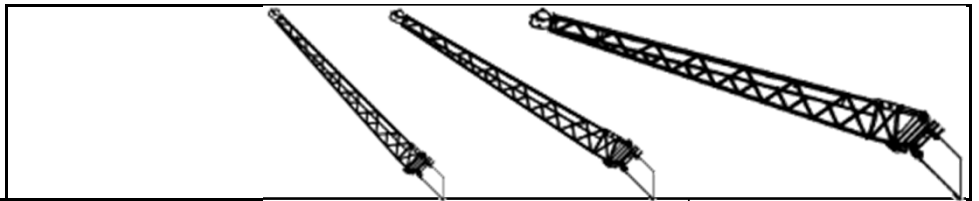

LOAD RADIUS (FT)	0° OFFSET			15° OFFSET			30° OFFSET			LOAD RADIUS (FT)
	BOOM ANGLE (DEG)	CODE 97	CODE 70	BOOM ANGLE (DEG)	CODE 106	CODE 79	BOOM ANGLE (DEG)	CODE 115	CODE 88	
		OVER REAR (LBS)	FULL 360° (LBS)		OVER REAR (LBS)	FULL 360° (LBS)		OVER REAR (LBS)	FULL 360° (LBS)	
6										6
8										8
10										10
12										12
15										15
20										20
25										25
30										30
35	79°	9000	9000							35
40	77°	9000	9000	79°	9000	9000				40
45	75°	9000	9000	78°	8580	8580				45
50	74°	9000	9000	76°	8130	8130	79°	7680	7680	50
55	72°	8560	8560	74°	7680	7680	77°	7270	7270	55
60	70°	8100	8100	73°	7260	7260	75°	6890	6890	60
65	68°	7680	7680	71°	6870	6870	73°	6540	6540	65
70	66°	7240	7240	69°	6510	6510	71°	6210	6210	70
75	64°	6840	6410	67°	6180	6180	69°	5910	5910	75
80	62°	6260	5410	65°	5850	5850	67°	5630	5630	80
85	60°	5730	4560	63°	5550	5100	65°	5360	5360	85
90	58°	5220	3810	61°	5090	4300	63°	5100	4710	90
95	55°	4750	3150	58°	4630	3600	60°	4850	3970	95
100	53°	4230	2570	56°	4190	2980	58°	4410	3300	100
105	50°	3630	2050	53°	3800	2420	55°	3990	2710	105
110	48°	3100	1580	50°	3430	1920	52°	3600	2170	110
115	45°	2610	1160	48°	2910	1460	49°	3130	1690	115
120	42°	2170		45°	2440	1050	46°	2630	1240	120
125	39°	1770		42°	2010		43°	2170		125
130	36°	1400		38°	1610		39°	1740		130
135	32°	1060		34°	1240		35°	1340		135
140				30°	890		30°	960		140
145										145
150										150



**CODES 71, 80, 89, 98,  
107, 116**  
**RETRACTED 30' JIB**

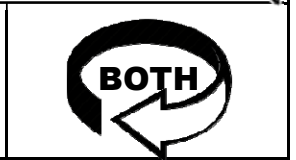
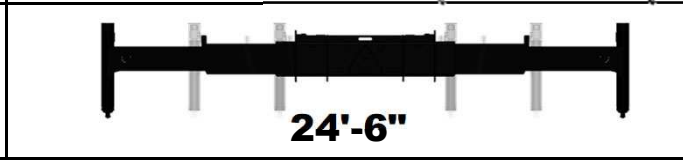
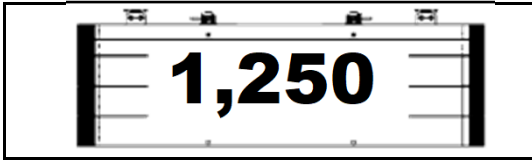
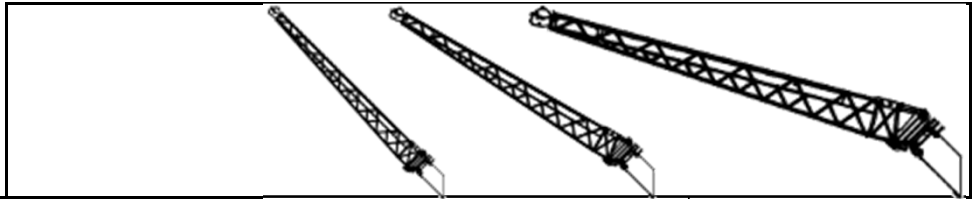

LOAD RADIUS (FT)	0° OFFSET			15° OFFSET			30° OFFSET			LOAD RADIUS (FT)
	BOOM ANGLE (DEG)	CODE 98	CODE 71	BOOM ANGLE (DEG)	CODE 107	CODE 80	BOOM ANGLE (DEG)	CODE 116	CODE 89	
		OVER REAR (LBS)	FULL 360° (LBS)		OVER REAR (LBS)	FULL 360° (LBS)		OVER REAR (LBS)	FULL 360° (LBS)	
6										6
8										8
10										10
12										12
15										15
20										20
25										25
30										30
35	79°	9000	9000							35
40	77°	9000	9000	79°	9000	9000				40
45	75°	9000	9000	78°	8580	8580				45
50	74°	9000	9000	76°	8130	8130	79°	7680	7680	50
55	72°	8560	8560	74°	7680	7680	77°	7270	7270	55
60	70°	8100	8100	73°	7260	7260	75°	6890	6890	60
65	68°	7680	7680	71°	6870	6870	73°	6540	6540	65
70	66°	7240	7140	69°	6510	6510	71°	6210	6210	70
75	64°	6840	6010	67°	6180	6180	69°	5910	5910	75
80	62°	6260	5050	65°	5850	5640	67°	5630	5630	80
85	60°	5730	4210	63°	5550	4760	65°	5360	5210	85
90	58°	5220	3490	61°	5090	3980	63°	5100	4390	90
95	55°	4630	2850	58°	4630	3300	60°	4850	3660	95
100	53°	3980	2280	56°	4190	2690	58°	4410	3020	100
105	50°	3400	1780	53°	3760	2150	55°	3990	2440	105
110	48°	2870	1330	50°	3200	1660	52°	3450	1920	110
115	45°	2400	920	48°	2700	1220	49°	2910	1450	115
120	42°	1970		45°	2230		46°	2420	1010	120
125	39°	1570		42°	1810		43°	1970		125
130	36°	1210		38°	1420		39°	1550		130
135	32°	870		34°	1060		35°	1160		135
140										140
145										145
150										150

**CODES 72, 81, 90, 99,  
108, 117**  
**RETRACTED 30' JIB**

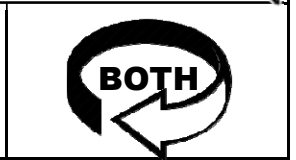
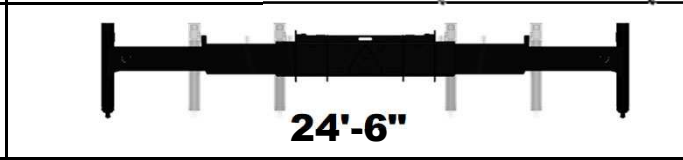
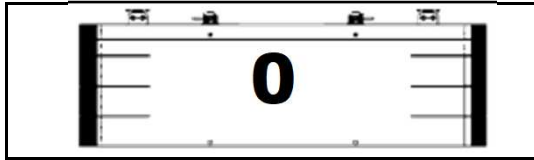
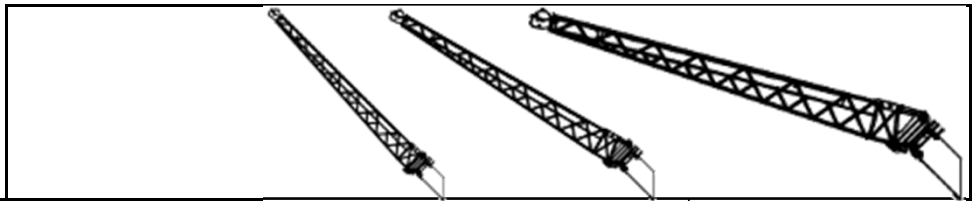

LOAD RADIUS (FT)	0° OFFSET			15° OFFSET			30° OFFSET			LOAD RADIUS (FT)
	BOOM ANGLE (DEG)	CODE 99	CODE 72	BOOM ANGLE (DEG)	CODE 108	CODE 81	BOOM ANGLE (DEG)	CODE 117	CODE 90	
		OVER REAR (LBS)	FULL 360° (LBS)		OVER REAR (LBS)	FULL 360° (LBS)		OVER REAR (LBS)	FULL 360° (LBS)	
6										6
8										8
10										10
12										12
15										15
20										20
25										25
30										30
35	79°	9000	9000							35
40	77°	9000	9000	79°	9000	9000				40
45	75°	9000	9000	78°	8580	8580				45
50	74°	9000	9000	76°	8130	8130	79°	7680	7680	50
55	72°	8560	8560	74°	7680	7680	77°	7270	7270	55
60	70°	8100	8100	73°	7260	7260	75°	6890	6890	60
65	68°	7680	7680	71°	6870	6870	73°	6540	6540	65
70	66°	7240	6710	69°	6510	6510	71°	6210	6210	70
75	64°	6840	5610	67°	6180	6180	69°	5910	5910	75
80	62°	6260	4680	65°	5850	5280	67°	5630	5630	80
85	60°	5730	3870	63°	5550	4410	65°	5360	4870	85
90	58°	5080	3170	61°	5090	3660	63°	5100	4070	90
95	55°	4360	2550	58°	4630	3000	60°	4850	3360	95
100	53°	3730	2000	56°	4130	2410	58°	4410	2730	100
105	50°	3160	1510	53°	3520	1880	55°	3800	2170	105
110	48°	2650	1070	50°	2980	1410	52°	3230	1660	110
115	45°	2180		48°	2480	980	49°	2700	1200	115
120	42°	1760		45°	2030		46°	2220		120
125	39°	1370		42°	1610		43°	1770		125
130	36°	1020		38°	1230		39°	1360		130
135				34°	880		35°	980		135
140										140
145										145
150										150

**CODES 118, 127, 136,  
145, 154, 163**  
**EXTENDED 50' JIB**

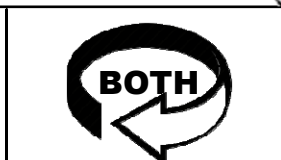
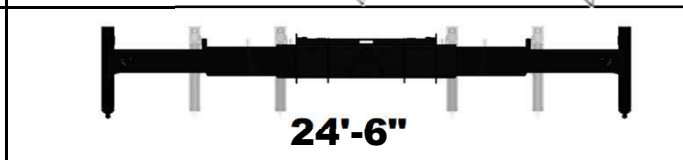
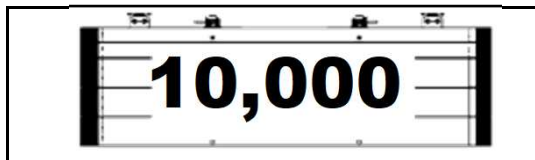

LOAD RADIUS (FT)	0° OFFSET			15° OFFSET			30° OFFSET			LOAD RADIUS (FT)
	BOOM ANGLE (DEG)	CODE 145 OVER REAR (LBS)	CODE 118 FULL 360° (LBS)	BOOM ANGLE (DEG)	CODE 154 OVER REAR (LBS)	CODE 127 FULL 360° (LBS)	BOOM ANGLE (DEG)	CODE 163 OVER REAR (LBS)	CODE 136 FULL 360° (LBS)	
25										25
30										30
35										35
40	79°	7600	7600							40
45	76°	7200	7200							45
50	75°	6900	6900	79°	6370	6370				50
55	73°	6500	6500	78°	6040	6040				55
60	72°	6200	6200	76°	5750	5750	79°	5340	5340	60
65	70°	5900	5900	75°	5460	5460	78°	5080	5080	65
70	69°	5600	5600	73°	5190	5190	76°	4840	4840	70
75	67°	5300	5300	71°	4940	4940	74°	4620	4620	75
80	66°	5000	5000	70°	4700	4700	72°	4410	4410	80
85	64°	4800	4800	68°	4470	4470	70°	4210	4210	85
90	63°	4500	4500	66°	4260	4260	69°	4020	4020	90
95	61°	4300	4300	64°	4060	4060	67°	3850	3850	95
100	59°	4100	4100	62°	3870	3870	65°	3680	3680	100
105	57°	3900	3900	60°	3690	3690	63°	3530	3530	105
110	54°	3600	3600	58°	3530	3530	61°	3390	3390	110
115	52°	3300	3300	56°	3370	3370	58°	3250	3250	115
120	49°	3000	3000	53°	3220	3220	56°	3130	3130	120
125	47°	2700	2600	51°	2980	2980	53°	3000	3000	125
130	44°	2400	2220	48°	2700	2610	50°	2890	2890	130
135	42°	2200	1870	45°	2440	2230	47°	2610	2500	135
140	39°	2000	1540	42°	2190	1870	44°	2340	2100	140
145	36°	1700	1240	39°	1950	1530	41°	2070	1730	145
150	33°	1500	960	36°	1720	1220	37°	1820	1380	150
155	30°	1300		32°	1500	930	32°	1580	1050	155
160										160
165										165
170										170
175										175
180										180

**CODES 119, 128, 137,  
146, 155, 164**  
**EXTENDED 50' JIB**

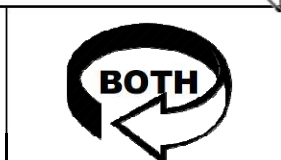
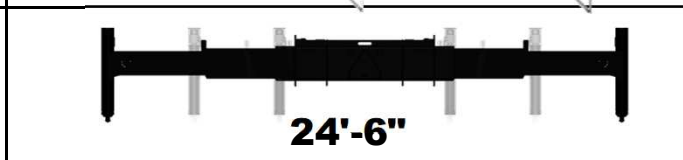
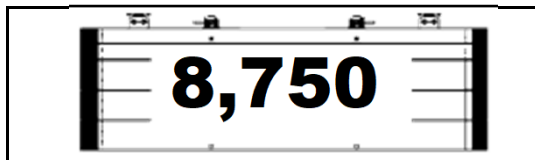
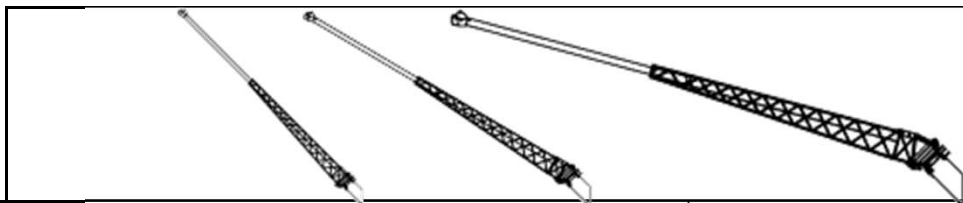

LOAD RADIUS (FT)	0° OFFSET			15° OFFSET			30° OFFSET			LOAD RADIUS (FT)
	BOOM ANGLE (DEG)	CODE 146 OVER REAR (LBS)	CODE 119 FULL 360° (LBS)	BOOM ANGLE (DEG)	CODE 155 OVER REAR (LBS)	CODE 128 FULL 360° (LBS)	BOOM ANGLE (DEG)	CODE 164 OVER REAR (LBS)	CODE 137 FULL 360° (LBS)	
25										25
30										30
35										35
40	79°	7600	7600							40
45	76°	7200	7200							45
50	75°	6900	6900	79°	6370	6370				50
55	73°	6500	6500	78°	6040	6040				55
60	72°	6200	6200	76°	5750	5750	79°	5340	5340	60
65	70°	5900	5900	75°	5460	5460	78°	5080	5080	65
70	69°	5600	5600	73°	5190	5190	76°	4840	4840	70
75	67°	5300	5300	71°	4940	4940	74°	4620	4620	75
80	66°	5000	5000	70°	4700	4700	72°	4410	4410	80
85	64°	4800	4800	68°	4470	4470	70°	4210	4210	85
90	63°	4500	4500	66°	4260	4260	69°	4020	4020	90
95	61°	4300	4300	64°	4060	4060	67°	3850	3850	95
100	59°	4100	4100	62°	3870	3870	65°	3680	3680	100
105	57°	3900	3900	60°	3690	3690	63°	3530	3530	105
110	54°	3600	3600	58°	3530	3530	61°	3390	3390	110
115	52°	3300	3230	56°	3370	3370	58°	3250	3250	115
120	49°	3000	2780	53°	3220	3220	56°	3130	3130	120
125	47°	2700	2380	51°	2980	2810	53°	3000	3000	125
130	44°	2400	2000	48°	2700	2400	50°	2890	2710	130
135	42°	2200	1660	45°	2440	2020	47°	2610	2290	135
140	39°	2000	1350	42°	2190	1670	44°	2340	1910	140
145	36°	1700	1050	39°	1950	1350	41°	2070	1540	145
150	33°	1500	780	36°	1720	1040	37°	1820	1200	150
155	30°	1300		32°	1500		32°	1580	870	155
160										160
165										165
170										170
175										175
180										180

**CODES 120, 129, 138,  
147, 156, 165**  
**EXTENDED 50' JIB**

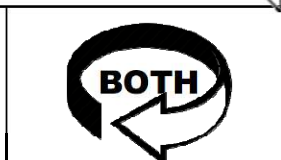
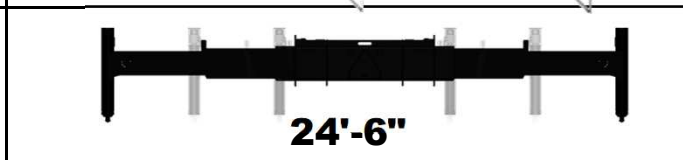
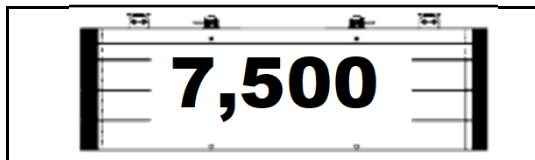
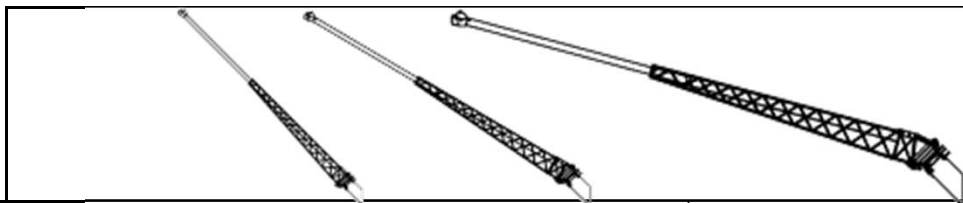

LOAD RADIUS (FT)	0° OFFSET			15° OFFSET			30° OFFSET			LOAD RADIUS (FT)
	BOOM ANGLE (DEG)	CODE 147 OVER REAR (LBS)	CODE 120 FULL 360° (LBS)	BOOM ANGLE (DEG)	CODE 156 OVER REAR (LBS)	CODE 129 FULL 360° (LBS)	BOOM ANGLE (DEG)	CODE 165 OVER REAR (LBS)	CODE 138 FULL 360° (LBS)	
25										25
30										30
35										35
40	79°	7600	7600							40
45	76°	7200	7200							45
50	75°	6900	6900	79°	6370	6370				50
55	73°	6500	6500	78°	6040	6040				55
60	72°	6200	6200	76°	5750	5750	79°	5340	5340	60
65	70°	5900	5900	75°	5460	5460	78°	5080	5080	65
70	69°	5600	5600	73°	5190	5190	76°	4840	4840	70
75	67°	5300	5300	71°	4940	4940	74°	4620	4620	75
80	66°	5000	5000	70°	4700	4700	72°	4410	4410	80
85	64°	4800	4800	68°	4470	4470	70°	4210	4210	85
90	63°	4500	4500	66°	4260	4260	69°	4020	4020	90
95	61°	4300	4300	64°	4060	4060	67°	3850	3850	95
100	59°	4100	4100	62°	3870	3870	65°	3680	3680	100
105	57°	3900	3900	60°	3690	3690	63°	3530	3530	105
110	54°	3600	3460	58°	3530	3530	61°	3390	3390	110
115	52°	3300	2980	56°	3370	3370	58°	3250	3250	115
120	49°	3000	2550	53°	3220	3030	56°	3130	3130	120
125	47°	2700	2150	51°	2980	2590	53°	3000	2930	125
130	44°	2400	1790	48°	2700	2190	50°	2890	2500	130
135	42°	2200	1460	45°	2440	1820	47°	2610	2090	135
140	39°	2000	1150	42°	2190	1480	44°	2340	1710	140
145	36°	1700	870	39°	1950	1160	41°	2070	1360	145
150	33°	1500		36°	1720	860	37°	1820	1020	150
155	30°	1300		32°	1500		32°	1580		155
160										160
165										165
170										170
175										175
180										180

**CODES 121, 130, 139,  
148, 157, 166**  
**EXTENDED 50' JIB**

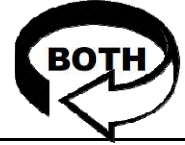
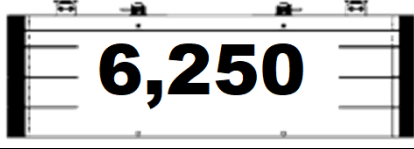
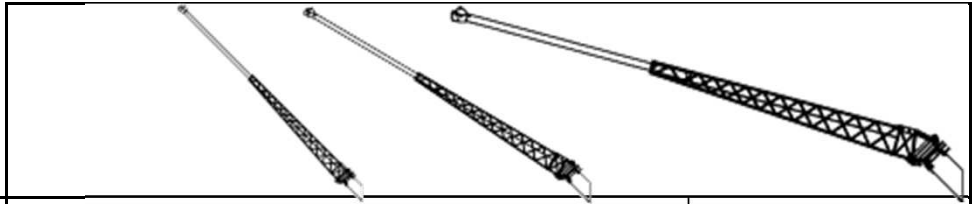

LOAD RADIUS (FT)	0° OFFSET			15° OFFSET			30° OFFSET			LOAD RADIUS (FT)
	BOOM ANGLE (DEG)	CODE 148	CODE 121	BOOM ANGLE (DEG)	CODE 157	CODE 130	BOOM ANGLE (DEG)	CODE 166	CODE 139	
		OVER REAR (LBS)	FULL 360° (LBS)		OVER REAR (LBS)	FULL 360° (LBS)		OVER REAR (LBS)	FULL 360° (LBS)	
25										25
30										30
35										35
40	79°	7600	7600							40
45	76°	7200	7200							45
50	75°	6900	6900	79°	6370	6370				50
55	73°	6500	6500	78°	6040	6040				55
60	72°	6200	6200	76°	5750	5750	79°	5340	5340	60
65	70°	5900	5900	75°	5460	5460	78°	5080	5080	65
70	69°	5600	5600	73°	5190	5190	76°	4840	4840	70
75	67°	5300	5300	71°	4940	4940	74°	4620	4620	75
80	66°	5000	5000	70°	4700	4700	72°	4410	4410	80
85	64°	4800	4800	68°	4470	4470	70°	4210	4210	85
90	63°	4500	4500	66°	4260	4260	69°	4020	4020	90
95	61°	4300	4300	64°	4060	4060	67°	3850	3850	95
100	59°	4100	4100	62°	3870	3870	65°	3680	3680	100
105	57°	3900	3720	60°	3690	3690	63°	3530	3530	105
110	54°	3600	3210	58°	3530	3530	61°	3390	3390	110
115	52°	3300	2740	56°	3370	3260	58°	3250	3250	115
120	49°	3000	2320	53°	3220	2790	56°	3130	3130	120
125	47°	2700	1930	51°	2980	2370	53°	3000	2710	125
130	44°	2400	1580	48°	2700	1980	50°	2890	2280	130
135	42°	2200	1260	45°	2440	1620	47°	2610	1890	135
140	39°	2000	960	42°	2190	1280	44°	2340	1520	140
145	36°	1700		39°	1950	970	41°	2070	1170	145
150	33°	1470		36°	1720		37°	1820	840	150
155	30°	1200		32°	1420		32°	1540		155
160										160
165										165
170										170
175										175
180										180

**CODES 122, 131, 140,  
149, 158, 167**  
**EXTENDED 50' JIB**

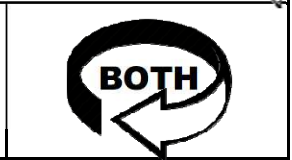
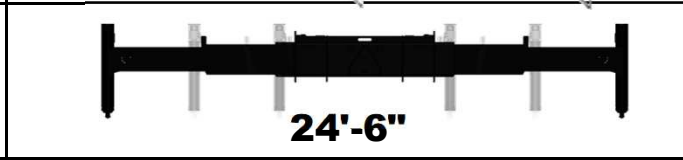
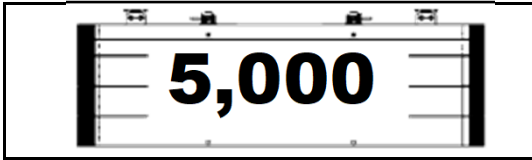
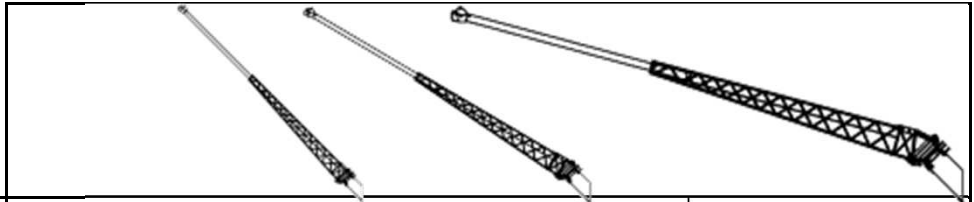

LOAD RADIUS (FT)	0° OFFSET			15° OFFSET			30° OFFSET			LOAD RADIUS (FT)
	BOOM ANGLE (DEG)	CODE 149 OVER REAR (LBS)	CODE 122 FULL 360° (LBS)	BOOM ANGLE (DEG)	CODE 158 OVER REAR (LBS)	CODE 131 FULL 360° (LBS)	BOOM ANGLE (DEG)	CODE 167 OVER REAR (LBS)	CODE 140 FULL 360° (LBS)	
25										25
30										30
35										35
40	79°	7600	7600							40
45	76°	7200	7200							45
50	75°	6900	6900	79°	6370	6370				50
55	73°	6500	6500	78°	6040	6040				55
60	72°	6200	6200	76°	5750	5750	79°	5340	5340	60
65	70°	5900	5900	75°	5460	5460	78°	5080	5080	65
70	69°	5600	5600	73°	5190	5190	76°	4840	4840	70
75	67°	5300	5300	71°	4940	4940	74°	4620	4620	75
80	66°	5000	5000	70°	4700	4700	72°	4410	4410	80
85	64°	4800	4800	68°	4470	4470	70°	4210	4210	85
90	63°	4500	4500	66°	4260	4260	69°	4020	4020	90
95	61°	4300	4300	64°	4060	4060	67°	3850	3850	95
100	59°	4100	4010	62°	3870	3870	65°	3680	3680	100
105	57°	3900	3450	60°	3690	3690	63°	3530	3530	105
110	54°	3600	2950	58°	3530	3510	61°	3390	3390	110
115	52°	3300	2500	56°	3370	3020	58°	3250	3250	115
120	49°	3000	2090	53°	3220	2560	56°	3130	2950	120
125	47°	2700	1710	51°	2980	2150	53°	3000	2490	125
130	44°	2400	1370	48°	2700	1770	50°	2890	2070	130
135	42°	2200	1050	45°	2440	1410	47°	2610	1680	135
140	39°	1900	760	42°	2190	1090	44°	2340	1320	140
145	36°	1600		39°	1880	780	41°	2070	980	145
150	33°	1310		36°	1560		37°	1720		150
155	30°	1040		32°	1260		32°	1380		155
160										160
165										165
170										170
175										175
180										180

**CODES 123, 132, 141,  
150, 159, 168**  
**EXTENDED 50' JIB**

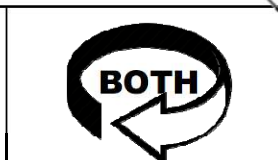
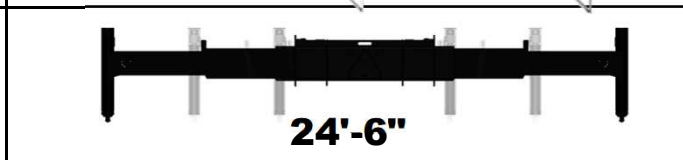
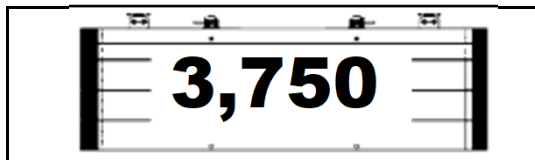
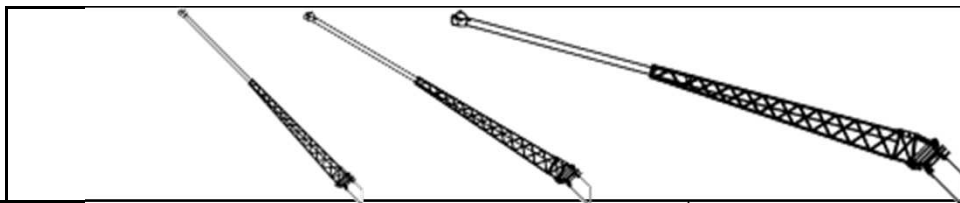

LOAD RADIUS (FT)	0° OFFSET			15° OFFSET			30° OFFSET			LOAD RADIUS (FT)
	BOOM ANGLE (DEG)	CODE 150	CODE 123	BOOM ANGLE (DEG)	CODE 159	CODE 132	BOOM ANGLE (DEG)	CODE 168	CODE 141	
		OVER REAR (LBS)	FULL 360° (LBS)		OVER REAR (LBS)	FULL 360° (LBS)		OVER REAR (LBS)	FULL 360° (LBS)	
25										25
30										30
35										35
40	79°	7600	7600							40
45	76°	7200	7200							45
50	75°	6900	6900	79°	6370	6370				50
55	73°	6500	6500	78°	6040	6040				55
60	72°	6200	6200	76°	5750	5750	79°	5340	5340	60
65	70°	5900	5900	75°	5460	5460	78°	5080	5080	65
70	69°	5600	5600	73°	5190	5190	76°	4840	4840	70
75	67°	5300	5300	71°	4940	4940	74°	4620	4620	75
80	66°	5000	5000	70°	4700	4700	72°	4410	4410	80
85	64°	4800	4800	68°	4470	4470	70°	4210	4210	85
90	63°	4500	4500	66°	4260	4260	69°	4020	4020	90
95	61°	4300	4300	64°	4060	4060	67°	3850	3850	95
100	59°	4100	3730	62°	3870	3870	65°	3680	3680	100
105	57°	3900	3190	60°	3690	3690	63°	3530	3530	105
110	54°	3600	2700	58°	3530	3260	61°	3390	3390	110
115	52°	3300	2260	56°	3370	2770	58°	3250	3200	115
120	49°	3000	1860	53°	3220	2330	56°	3130	2710	120
125	47°	2700	1490	51°	2980	1930	53°	3000	2270	125
130	44°	2400	1160	48°	2700	1550	50°	2890	1860	130
135	42°	2060	850	45°	2410	1210	47°	2610	1480	135
140	39°	1730		42°	2050	890	44°	2280	1130	140
145	36°	1430		39°	1720		41°	1910	790	145
150	33°	1150		36°	1400		37°	1560		150
155	30°	890		32°	1110		32°	1230		155
160										160
165										165
170										170
175										175
180										180



**CODES 124, 133, 142,  
151, 160, 169**  
**EXTENDED 50' JIB**

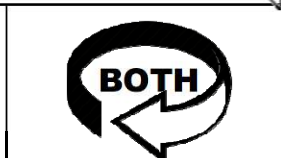
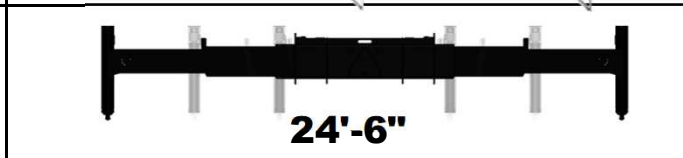
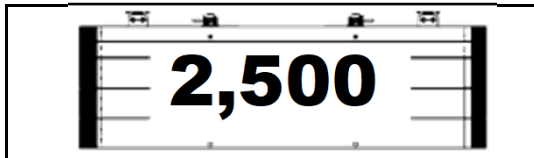
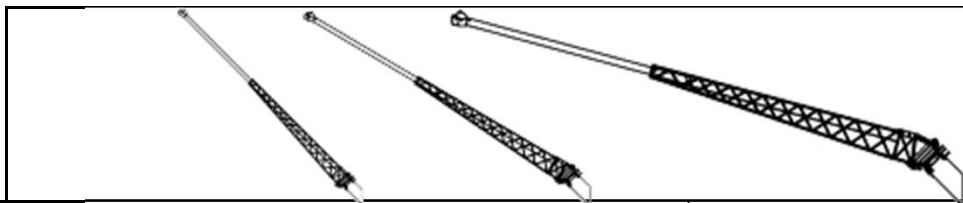

LOAD RADIUS (FT)	0° OFFSET			15° OFFSET			30° OFFSET			LOAD RADIUS (FT)
	BOOM ANGLE (DEG)	CODE 151	CODE 124	BOOM ANGLE (DEG)	CODE 160	CODE 133	BOOM ANGLE (DEG)	CODE 169	CODE 142	
		OVER REAR (LBS)	FULL 360° (LBS)		OVER REAR (LBS)	FULL 360° (LBS)		OVER REAR (LBS)	FULL 360° (LBS)	
25										25
30										30
35										35
40	79°	7600	7600							40
45	76°	7200	7200							45
50	75°	6900	6900	79°	6370	6370				50
55	73°	6500	6500	78°	6040	6040				55
60	72°	6200	6200	76°	5750	5750	79°	5340	5340	60
65	70°	5900	5900	75°	5460	5460	78°	5080	5080	65
70	69°	5600	5600	73°	5190	5190	76°	4840	4840	70
75	67°	5300	5300	71°	4940	4940	74°	4620	4620	75
80	66°	5000	5000	70°	4700	4700	72°	4410	4410	80
85	64°	4800	4800	68°	4470	4470	70°	4210	4210	85
90	63°	4500	4500	66°	4260	4260	69°	4020	4020	90
95	61°	4300	4040	64°	4060	4060	67°	3850	3850	95
100	59°	4100	3440	62°	3870	3870	65°	3680	3680	100
105	57°	3900	2920	60°	3690	3530	63°	3530	3530	105
110	54°	3600	2440	58°	3530	3000	61°	3390	3390	110
115	52°	3300	2010	56°	3370	2530	58°	3250	2950	115
120	49°	3000	1620	53°	3220	2100	56°	3130	2480	120
125	47°	2590	1270	51°	2980	1700	53°	3000	2050	125
130	44°	2220	940	48°	2610	1340	50°	2890	1650	130
135	42°	1880		45°	2230	1010	47°	2500	1280	135
140	39°	1560		42°	1880		44°	2110	930	140
145	36°	1260		39°	1550		41°	1740		145
150	33°	990		36°	1240		37°	1400		150
155				32°	950		32°	1070		155
160										160
165										165
170										170
175										175
180										180

**CODES 125, 134, 143,  
152, 161, 170**  
**EXTENDED 50' JIB**

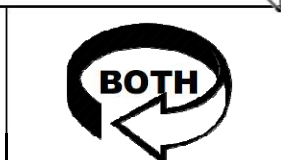
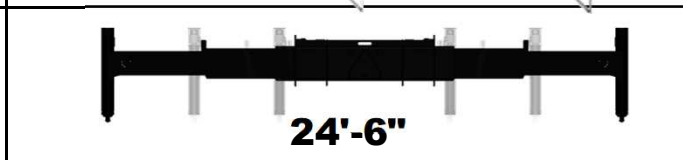
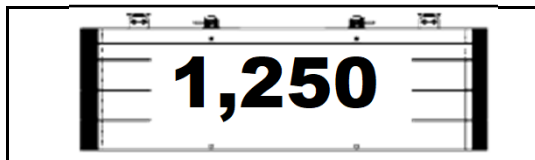
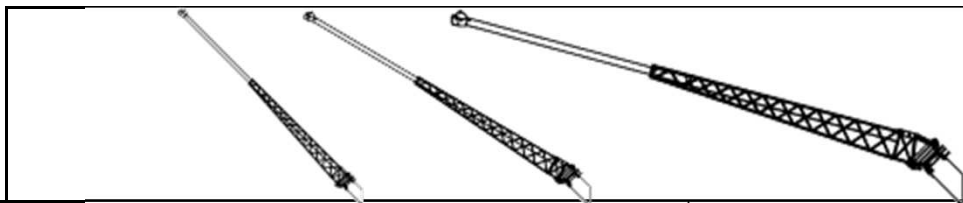

LOAD RADIUS (FT)	BOOM ANGLE (DEG)	0° OFFSET		BOOM ANGLE (DEG)	15° OFFSET		BOOM ANGLE (DEG)	30° OFFSET		LOAD RADIUS (FT)
		CODE 152 OVER REAR (LBS)	CODE 125 FULL 360° (LBS)		CODE 161 OVER REAR (LBS)	CODE 134 FULL 360° (LBS)		CODE 170 OVER REAR (LBS)	CODE 143 FULL 360° (LBS)	
25										25
30										30
35										35
40	79°	7600	7600							40
45	76°	7200	7200							45
50	75°	6900	6900	79°	6370	6370				50
55	73°	6500	6500	78°	6040	6040				55
60	72°	6200	6200	76°	5750	5750	79°	5340	5340	60
65	70°	5900	5900	75°	5460	5460	78°	5080	5080	65
70	69°	5600	5600	73°	5190	5190	76°	4840	4840	70
75	67°	5300	5300	71°	4940	4940	74°	4620	4620	75
80	66°	5000	5000	70°	4700	4700	72°	4410	4410	80
85	64°	4800	4800	68°	4470	4470	70°	4210	4210	85
90	63°	4500	4380	66°	4260	4260	69°	4020	4020	90
95	61°	4300	3740	64°	4060	4060	67°	3850	3850	95
100	59°	4100	3160	62°	3870	3820	65°	3680	3680	100
105	57°	3900	2650	60°	3690	3260	63°	3530	3530	105
110	54°	3600	2190	58°	3530	2750	61°	3390	3220	110
115	52°	3230	1770	56°	3370	2290	58°	3250	2710	115
120	49°	2800	1390	53°	3220	1870	56°	3130	2250	120
125	47°	2400	1050	51°	2820	1480	53°	3000	1830	125
130	44°	2030		48°	2420	1130	50°	2720	1440	130
135	42°	1690		45°	2050	800	47°	2310	1070	135
140	39°	1380		42°	1700		44°	1930		140
145	36°	1090		39°	1380		41°	1580		145
150	33°	830		36°	1080		37°	1240		150
155				32°	790		32°	910		155
160										160
165										165
170										170
175										175
180										180

**CODES 126, 135, 144,  
153, 162, 171**  
**EXTENDED 50' JIB**

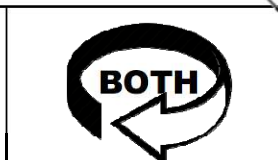
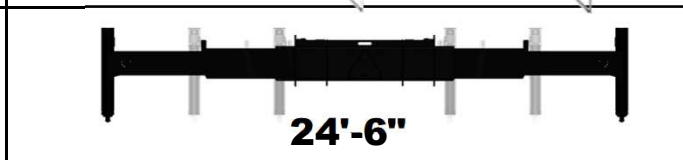
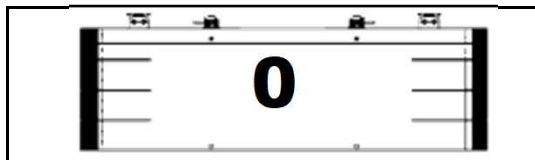
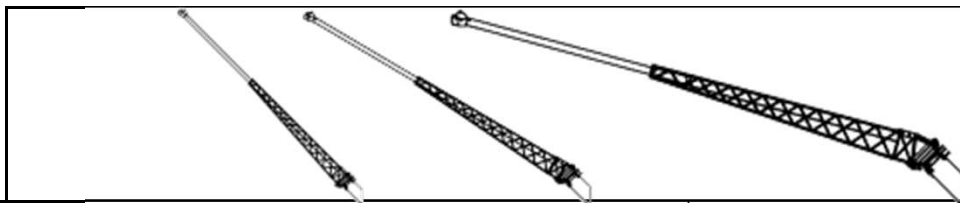

LOAD RADIUS (FT)	BOOM ANGLE (DEG)	0° OFFSET		BOOM ANGLE (DEG)	15° OFFSET		BOOM ANGLE (DEG)	30° OFFSET		LOAD RADIUS (FT)
		CODE 153 OVER REAR (LBS)	CODE 126 FULL 360° (LBS)		CODE 162 OVER REAR (LBS)	CODE 135 FULL 360° (LBS)		CODE 171 OVER REAR (LBS)	CODE 144 FULL 360° (LBS)	
25										25
30										30
35										35
40	79°	7600	7600							40
45	76°	7200	7200							45
50	75°	6900	6900	79°	6370	6370				50
55	73°	6500	6500	78°	6040	6040				55
60	72°	6200	6200	76°	5750	5750	79°	5340	5340	60
65	70°	5900	5900	75°	5460	5460	78°	5080	5080	65
70	69°	5600	5600	73°	5190	5190	76°	4840	4840	70
75	67°	5300	5300	71°	4940	4940	74°	4620	4620	75
80	66°	5000	5000	70°	4700	4700	72°	4410	4410	80
85	64°	4800	4780	68°	4470	4470	70°	4210	4210	85
90	63°	4500	4060	66°	4260	4260	69°	4020	4020	90
95	61°	4300	3430	64°	4060	4060	67°	3850	3850	95
100	59°	4100	2880	62°	3870	3540	65°	3680	3680	100
105	57°	3900	2380	60°	3690	2990	63°	3530	3500	105
110	54°	3490	1930	58°	3530	2490	61°	3390	2960	110
115	52°	3020	1530	56°	3370	2040	58°	3250	2470	115
120	49°	2590	1160	53°	3060	1640	56°	3130	2020	120
125	47°	2200	830	51°	2630	1260	53°	2960	1610	125
130	44°	1840		48°	2230	920	50°	2530	1220	130
135	42°	1510		45°	1870		47°	2130	870	135
140	39°	1210		42°	1530		44°	1760		140
145	36°	930		39°	1210		41°	1410		145
150				36°	920		37°	1080		150
155							32°	760		155
160										160
165										165
170										170
175										175
180										180

**CODES 172, 181, 190,  
199, 208, 217**  
**FIXED 30' JIB**

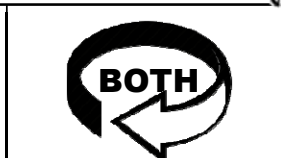
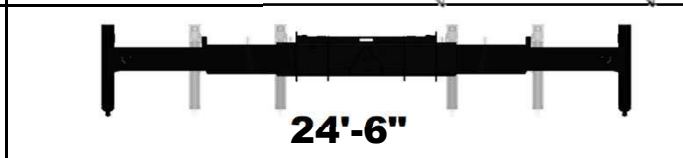
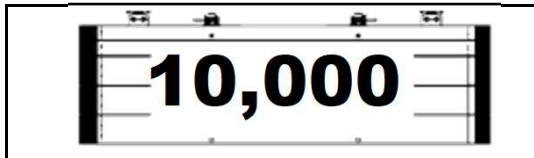
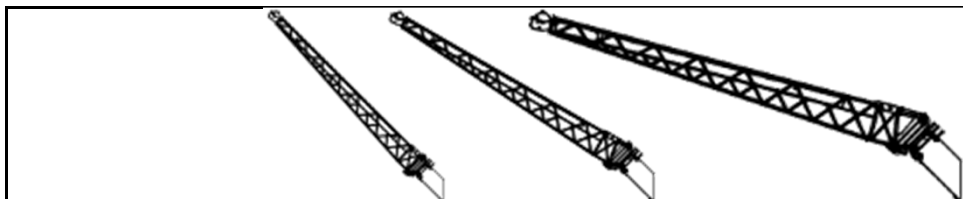

LOAD RADIUS (FT)	0° OFFSET			15° OFFSET			30° OFFSET			LOAD RADIUS (FT)
	BOOM ANGLE (DEG)	CODE 199	CODE 172	BOOM ANGLE (DEG)	CODE 208	CODE 181	BOOM ANGLE (DEG)	CODE 217	CODE 190	
		OVER REAR (LBS)	FULL 360° (LBS)		OVER REAR (LBS)	FULL 360° (LBS)		OVER REAR (LBS)	FULL 360° (LBS)	
6										6
8										8
10										10
12										12
15										15
20										20
25										25
30										30
35	79°	9000	9000							35
40	77°	9000	9000	79°	9000	9000				40
45	75°	9000	9000	78°	8580	8580				45
50	74°	8780	8780	76°	8130	8130	79°	7680	7680	50
55	72°	8520	8520	74°	7680	7680	77°	7590	7590	55
60	70°	8190	8190	73°	7260	7260	75°	7510	7510	60
65	68°	7760	7760	71°	6870	6870	73°	7160	7160	65
70	66°	7360	7360	69°	6490	6490	71°	6830	6830	70
75	64°	6840	6840	67°	6300	6300	69°	6530	6530	75
80	62°	6310	6310	65°	6280	6280	67°	6250	6250	80
85	60°	5840	5840	63°	5980	5980	65°	5980	5980	85
90	58°	5370	5370	61°	5540	5540	63°	5720	5720	90
95	55°	4940	4940	58°	5090	5090	60°	5470	5470	95
100	53°	4520	4520	56°	4670	4670	58°	5030	5030	100
105	50°	4140	4140	53°	4290	4290	55°	4610	4610	105
110	48°	3790	3590	50°	3930	3920	52°	4220	4160	110
115	45°	3450	3100	48°	3590	3390	49°	3850	3610	115
120	42°	3140	2640	45°	3280	2910	46°	3500	3100	120
125	39°	2860	2230	42°	2980	2470	43°	3170	2630	125
130	36°	2590	1860	38°	2700	2060	39°	2860	2190	130
135	32°	2340	1510	34°	2430	1690	35°	2570	1790	135
140	28°	2110	1190	30°	2170	1340	30°	2290	1410	140
145										145
150										150

**CODES 173, 182, 191,  
200, 209, 218**  
**FIXED 30' JIB**

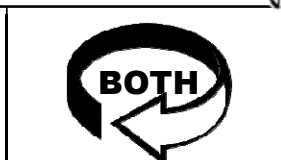
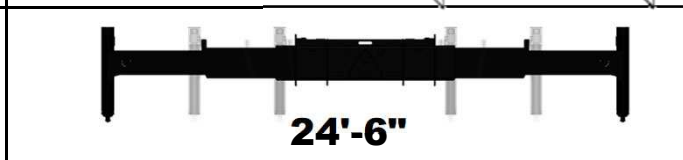
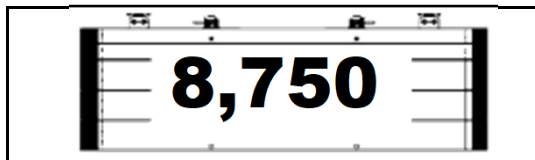
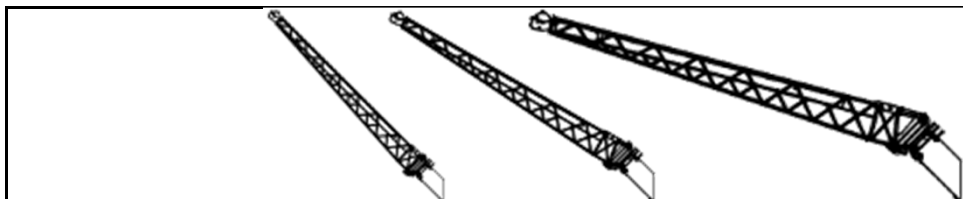

LOAD RADIUS (FT)	0° OFFSET				15° OFFSET			30° OFFSET			LOAD RADIUS (FT)
	BOOM ANGLE (DEG)	CODE 200	CODE 173	BOOM ANGLE (DEG)	CODE 209	CODE 182	BOOM ANGLE (DEG)	CODE 218	CODE 191		
		OVER REAR (LBS)	FULL 360° (LBS)		OVER REAR (LBS)	FULL 360° (LBS)		OVER REAR (LBS)	FULL 360° (LBS)		
6										6	
8										8	
10										10	
12										12	
15										15	
20										20	
25										25	
30										30	
35	79°	9000	9000							35	
40	77°	9000	9000	79°	9000	9000				40	
45	75°	9000	9000	78°	8580	8580				45	
50	74°	8780	8780	76°	8130	8130	79°	7680	7680	50	
55	72°	8520	8520	74°	7680	7680	77°	7590	7590	55	
60	70°	8190	8190	73°	7260	7260	75°	7510	7510	60	
65	68°	7760	7760	71°	6870	6870	73°	7160	7160	65	
70	66°	7360	7360	69°	6490	6490	71°	6830	6830	70	
75	64°	6840	6840	67°	6300	6300	69°	6530	6530	75	
80	62°	6310	6310	65°	6280	6280	67°	6250	6250	80	
85	60°	5840	5840	63°	5980	5980	65°	5980	5980	85	
90	58°	5370	5370	61°	5540	5540	63°	5720	5720	90	
95	55°	4940	4940	58°	5090	5090	60°	5470	5470	95	
100	53°	4520	4470	56°	4670	4670	58°	5030	5030	100	
105	50°	4140	3870	53°	4290	4230	55°	4610	4510	105	
110	48°	3790	3340	50°	3930	3660	52°	4220	3910	110	
115	45°	3450	2850	48°	3590	3150	49°	3850	3360	115	
120	42°	3140	2410	45°	3280	2680	46°	3500	2860	120	
125	39°	2860	2010	42°	2980	2250	43°	3170	2410	125	
130	36°	2590	1650	38°	2700	1850	39°	2860	1980	130	
135	32°	2340	1310	34°	2430	1490	35°	2570	1590	135	
140	28°	2090	1000	30°	2170	1140	30°	2290	1210	140	
145										145	
150										150	

**CODES 174, 183, 192,  
201, 210, 219**  
**FIXED 30' JIB**

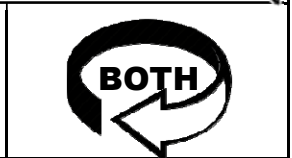
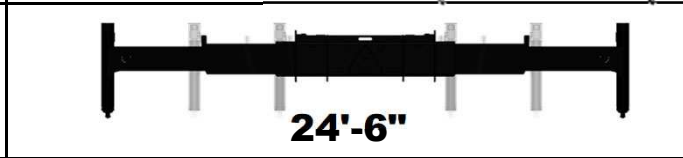
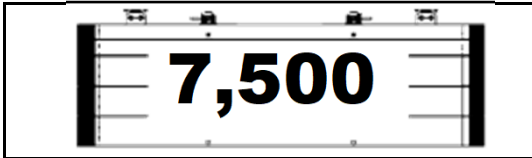
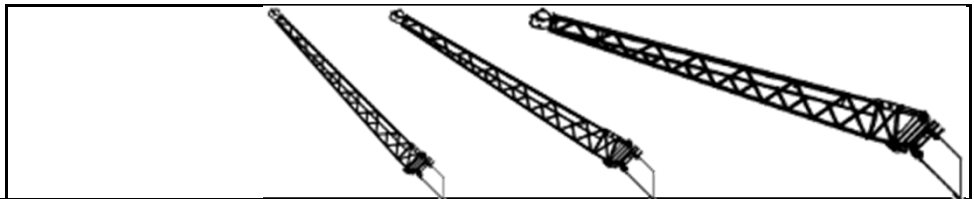

LOAD RADIUS (FT)	0° OFFSET			15° OFFSET			30° OFFSET			LOAD RADIUS (FT)
	BOOM ANGLE (DEG)	CODE 201	CODE 174	BOOM ANGLE (DEG)	CODE 210	CODE 183	BOOM ANGLE (DEG)	CODE 219	CODE 192	
		OVER REAR (LBS)	FULL 360° (LBS)		OVER REAR (LBS)	FULL 360° (LBS)		OVER REAR (LBS)	FULL 360° (LBS)	
6										6
8										8
10										10
12										12
15										15
20										20
25										25
30										30
35	79°	9000	9000							35
40	77°	9000	9000	79°	9000	9000				40
45	75°	9000	9000	78°	8580	8580				45
50	74°	8780	8780	76°	8130	8130	79°	7680	7680	50
55	72°	8520	8520	74°	7680	7680	77°	7590	7590	55
60	70°	8190	8190	73°	7260	7260	75°	7510	7510	60
65	68°	7760	7760	71°	6870	6870	73°	7160	7160	65
70	66°	7360	7360	69°	6490	6490	71°	6830	6830	70
75	64°	6840	6840	67°	6300	6300	69°	6530	6530	75
80	62°	6310	6310	65°	6280	6280	67°	6250	6250	80
85	60°	5840	5840	63°	5980	5980	65°	5980	5980	85
90	58°	5370	5370	61°	5540	5540	63°	5720	5720	90
95	55°	4940	4840	58°	5090	5090	60°	5470	5470	95
100	53°	4520	4180	56°	4670	4580	58°	5030	4890	100
105	50°	4140	3600	53°	4290	3960	55°	4610	4240	105
110	48°	3790	3080	50°	3930	3410	52°	4220	3650	110
115	45°	3450	2610	48°	3590	2900	49°	3850	3120	115
120	42°	3140	2180	45°	3280	2450	46°	3500	2630	120
125	39°	2860	1790	42°	2980	2030	43°	3170	2180	125
130	36°	2590	1430	38°	2700	1640	39°	2860	1770	130
135	32°	2260	1100	34°	2430	1280	35°	2530	1380	135
140	28°	1920		30°	2060	950	30°	2130	1020	140
145										145
150										150

**CODES 175, 184, 193,  
202, 211, 220**  
**FIXED 30' JIB**

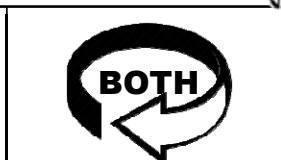
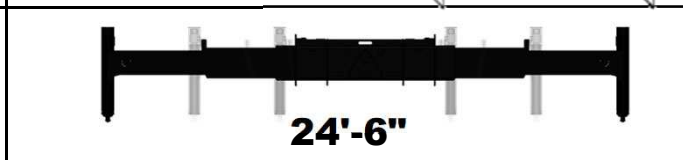
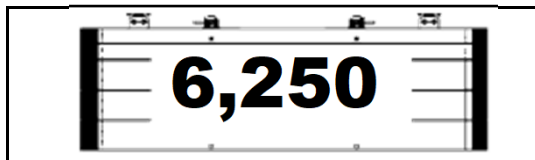
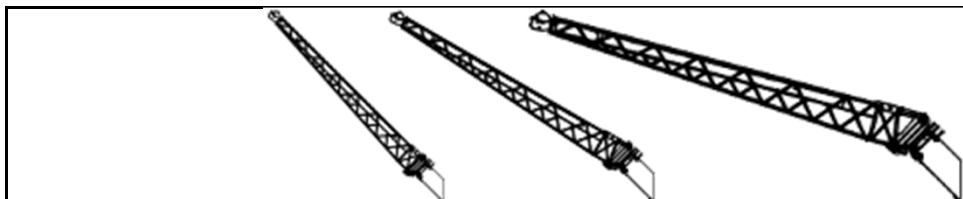

LOAD RADIUS (FT)	0° OFFSET			15° OFFSET			30° OFFSET			LOAD RADIUS (FT)
	BOOM ANGLE (DEG)	CODE 202	CODE 175	BOOM ANGLE (DEG)	CODE 211	CODE 184	BOOM ANGLE (DEG)	CODE 220	CODE 193	
		OVER REAR (LBS)	FULL 360° (LBS)		OVER REAR (LBS)	FULL 360° (LBS)		OVER REAR (LBS)	FULL 360° (LBS)	
6										6
8										8
10										10
12										12
15										15
20										20
25										25
30										30
35	79°	9000	9000							35
40	77°	9000	9000	79°	9000	9000				40
45	75°	9000	9000	78°	8580	8580				45
50	74°	8780	8780	76°	8130	8130	79°	7680	7680	50
55	72°	8520	8520	74°	7680	7680	77°	7590	7590	55
60	70°	8190	8190	73°	7260	7260	75°	7510	7510	60
65	68°	7760	7760	71°	6870	6870	73°	7160	7160	65
70	66°	7360	7360	69°	6490	6490	71°	6830	6830	70
75	64°	6840	6840	67°	6300	6300	69°	6530	6530	75
80	62°	6310	6310	65°	6280	6280	67°	6250	6250	80
85	60°	5840	5840	63°	5980	5980	65°	5980	5980	85
90	58°	5370	5250	61°	5540	5540	63°	5720	5720	90
95	55°	4940	4530	58°	5090	4970	60°	5470	5320	95
100	53°	4520	3900	56°	4670	4290	58°	5030	4610	100
105	50°	4140	3330	53°	4290	3690	55°	4610	3970	105
110	48°	3790	2830	50°	3930	3150	52°	4220	3400	110
115	45°	3450	2370	48°	3590	2660	49°	3850	2880	115
120	42°	3140	1950	45°	3280	2210	46°	3500	2400	120
125	39°	2840	1570	42°	2980	1800	43°	3170	1960	125
130	36°	2440	1220	38°	2650	1430	39°	2770	1560	130
135	32°	2080	900	34°	2250	1080	35°	2350	1180	135
140	28°	1740		30°	1890		30°	1960		140
145										145
150										150

**CODES 176, 185, 194,  
203, 212, 221**  
**FIXED 30' JIB**

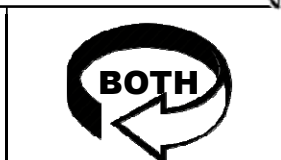
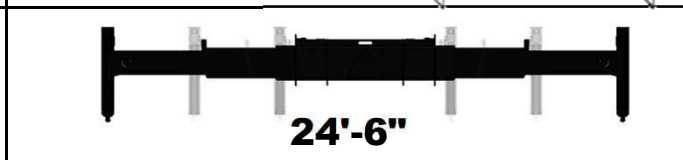
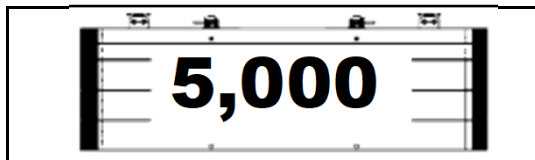
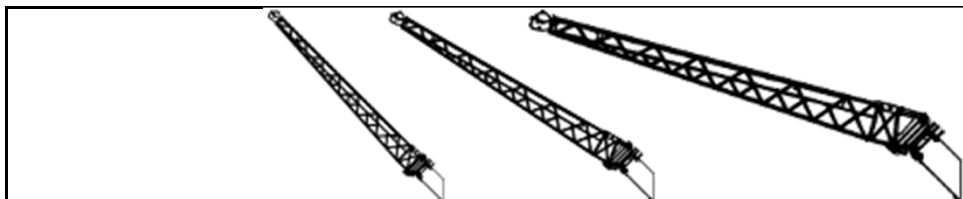

LOAD RADIUS (FT)	0° OFFSET			15° OFFSET			30° OFFSET			LOAD RADIUS (FT)
	BOOM ANGLE (DEG)	CODE 203	CODE 176	BOOM ANGLE (DEG)	CODE 212	CODE 185	BOOM ANGLE (DEG)	CODE 221	CODE 194	
		OVER REAR (LBS)	FULL 360° (LBS)		OVER REAR (LBS)	FULL 360° (LBS)		OVER REAR (LBS)	FULL 360° (LBS)	
6										6
8										8
10										10
12										12
15										15
20										20
25										25
30										30
35	79°	9000	9000							35
40	77°	9000	9000	79°	9000	9000				40
45	75°	9000	9000	78°	8580	8580				45
50	74°	8780	8780	76°	8130	8130	79°	7680	7680	50
55	72°	8520	8520	74°	7680	7680	77°	7590	7590	55
60	70°	8190	8190	73°	7260	7260	75°	7510	7510	60
65	68°	7760	7760	71°	6870	6870	73°	7160	7160	65
70	66°	7360	7360	69°	6490	6490	71°	6830	6830	70
75	64°	6840	6840	67°	6300	6300	69°	6530	6530	75
80	62°	6310	6310	65°	6280	6280	67°	6250	6250	80
85	60°	5840	5720	63°	5980	5980	65°	5980	5980	85
90	58°	5370	4930	61°	5540	5400	63°	5720	5720	90
95	55°	4940	4230	58°	5090	4670	60°	5470	5020	95
100	53°	4520	3620	56°	4670	4010	58°	5030	4320	100
105	50°	4140	3060	53°	4290	3420	55°	4610	3700	105
110	48°	3790	2570	50°	3930	2900	52°	4220	3140	110
115	45°	3450	2120	48°	3590	2420	49°	3850	2630	115
120	42°	3060	1720	45°	3280	1980	46°	3500	2170	120
125	39°	2640	1350	42°	2870	1580	43°	3030	1740	125
130	36°	2250	1010	38°	2460	1220	39°	2580	1350	130
135	32°	1900		34°	2070	880	35°	2170	980	135
140	28°	1570		30°	1710		30°	1780		140
145										145
150										150



**CODES 177, 186, 195,  
204, 213, 222**  
**FIXED 30' JIB**

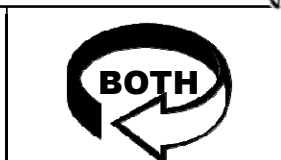
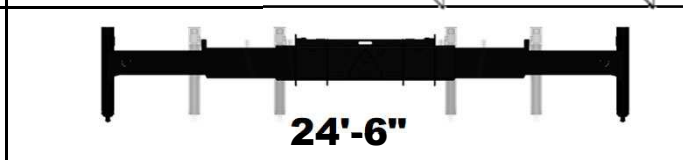
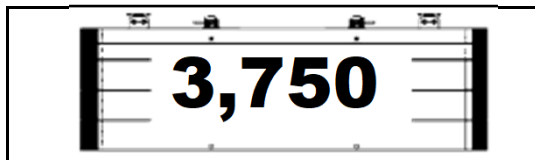
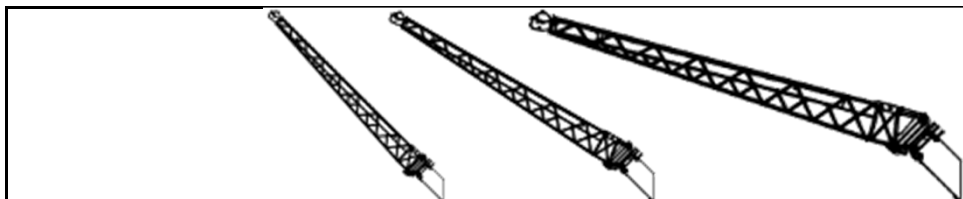

LOAD RADIUS (FT)	0° OFFSET			15° OFFSET			30° OFFSET			LOAD RADIUS (FT)
	BOOM ANGLE (DEG)	CODE 204	CODE 177	BOOM ANGLE (DEG)	CODE 213	CODE 186	BOOM ANGLE (DEG)	CODE 222	CODE 195	
		OVER REAR (LBS)	FULL 360° (LBS)		OVER REAR (LBS)	FULL 360° (LBS)		OVER REAR (LBS)	FULL 360° (LBS)	
6										6
8										8
10										10
12										12
15										15
20										20
25										25
30										30
35	79°	9000	9000							35
40	77°	9000	9000	79°	9000	9000				40
45	75°	9000	9000	78°	8580	8580				45
50	74°	8780	8780	76°	8130	8130	79°	7680	7680	50
55	72°	8520	8520	74°	7680	7680	77°	7590	7590	55
60	70°	8190	8190	73°	7260	7260	75°	7510	7510	60
65	68°	7760	7760	71°	6870	6870	73°	7160	7160	65
70	66°	7360	7360	69°	6490	6490	71°	6830	6830	70
75	64°	6840	6840	67°	6300	6300	69°	6530	6530	75
80	62°	6310	6260	65°	6280	6280	67°	6250	6250	80
85	60°	5840	5380	63°	5980	5900	65°	5980	5980	85
90	58°	5370	4610	61°	5540	5080	63°	5720	5470	90
95	55°	4940	3930	58°	5090	4360	60°	5470	4720	95
100	53°	4520	3330	56°	4670	3730	58°	5030	4040	100
105	50°	4140	2800	53°	4290	3150	55°	4610	3430	105
110	48°	3790	2310	50°	3930	2640	52°	4220	2890	110
115	45°	3310	1880	48°	3590	2170	49°	3810	2390	115
120	42°	2860	1490	45°	3120	1750	46°	3300	1940	120
125	39°	2440	1130	42°	2670	1360	43°	2830	1520	125
130	36°	2070		38°	2270	1000	39°	2400	1130	130
135	32°	1720		34°	1890		35°	1990		135
140	28°	1390		30°	1540		30°	1610		140
145										145
150										150

**CODES 178, 187, 196,  
205, 214, 223**  
**FIXED 30' JIB**

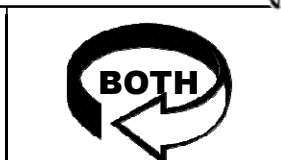
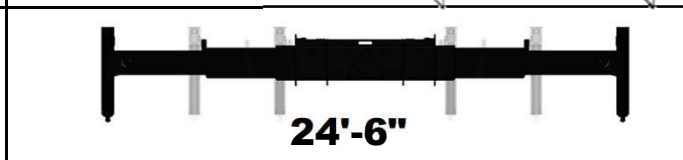
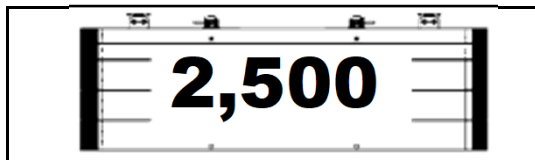
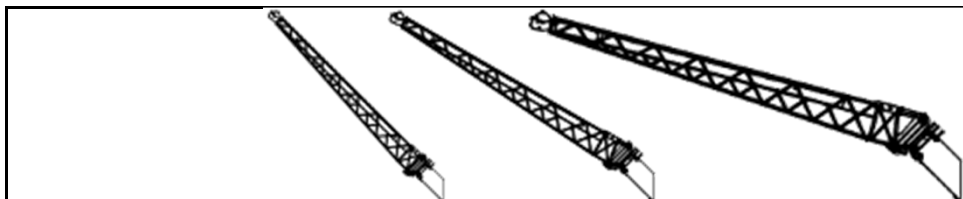

LOAD RADIUS (FT)	0° OFFSET			15° OFFSET			30° OFFSET			LOAD RADIUS (FT)
	BOOM ANGLE (DEG)	CODE 205	CODE 178	BOOM ANGLE (DEG)	CODE 214	CODE 187	BOOM ANGLE (DEG)	CODE 223	CODE 196	
		OVER REAR (LBS)	FULL 360° (LBS)		OVER REAR (LBS)	FULL 360° (LBS)		OVER REAR (LBS)	FULL 360° (LBS)	
6										6
8										8
10										10
12										12
15										15
20										20
25										25
30										30
35	79°	9000	9000							35
40	77°	9000	9000	79°	9000	9000				40
45	75°	9000	9000	78°	8580	8580				45
50	74°	8780	8780	76°	8130	8130	79°	7680	7680	50
55	72°	8520	8520	74°	7680	7680	77°	7590	7590	55
60	70°	8190	8190	73°	7260	7260	75°	7510	7510	60
65	68°	7760	7760	71°	6870	6870	73°	7160	7160	65
70	66°	7360	7360	69°	6490	6490	71°	6830	6830	70
75	64°	6840	6840	67°	6300	6300	69°	6530	6530	75
80	62°	6310	5890	65°	6280	6280	67°	6250	6250	80
85	60°	5840	5030	63°	5980	5560	65°	5980	5980	85
90	58°	5370	4290	61°	5540	4760	63°	5720	5150	90
95	55°	4940	3630	58°	5090	4060	60°	5470	4410	95
100	53°	4520	3050	56°	4670	3440	58°	5030	3760	100
105	50°	4110	2530	53°	4290	2890	55°	4610	3170	105
110	48°	3580	2060	50°	3900	2390	52°	4140	2630	110
115	45°	3090	1640	48°	3380	1930	49°	3590	2150	115
120	42°	2650	1250	45°	2910	1520	46°	3090	1710	120
125	39°	2250	910	42°	2480	1140	43°	2630	1300	125
130	36°	1880		38°	2080		39°	2210	920	130
135	32°	1540		34°	1710		35°	1810		135
140	28°	1220		30°	1370		30°	1430		140
145										145
150										150

**CODES 179, 188, 197,  
206, 215, 224**  
**FIXED 30' JIB**

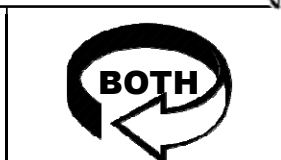
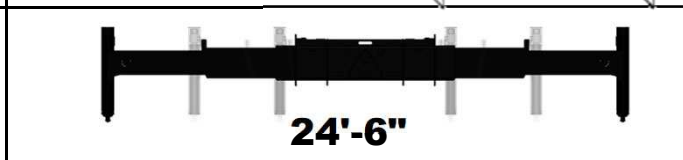
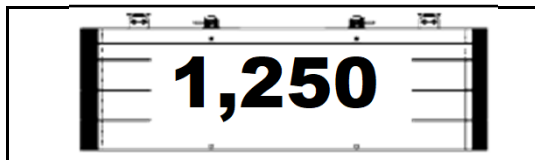
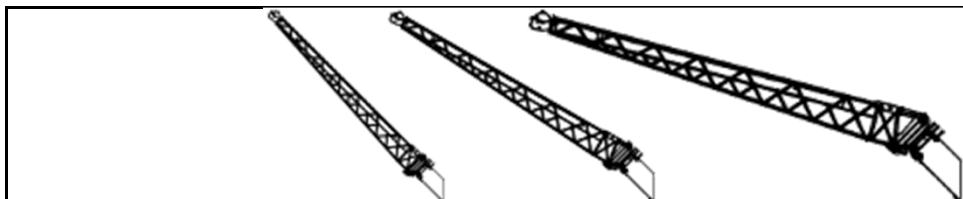

LOAD RADIUS (FT)	0° OFFSET			15° OFFSET			30° OFFSET			LOAD RADIUS (FT)
	BOOM ANGLE (DEG)	CODE 206	CODE 179	BOOM ANGLE (DEG)	CODE 215	CODE 188	BOOM ANGLE (DEG)	CODE 224	CODE 197	
		OVER REAR (LBS)	FULL 360° (LBS)		OVER REAR (LBS)	FULL 360° (LBS)		OVER REAR (LBS)	FULL 360° (LBS)	
6										6
8										8
10										10
12										12
15										15
20										20
25										25
30										30
35	79°	9000	9000							35
40	77°	9000	9000	79°	9000	9000				40
45	75°	9000	9000	78°	8580	8580				45
50	74°	8780	8780	76°	8130	8130	79°	7680	7680	50
55	72°	8520	8520	74°	7680	7680	77°	7590	7590	55
60	70°	8190	8190	73°	7260	7260	75°	7510	7510	60
65	68°	7760	7760	71°	6870	6870	73°	7160	7160	65
70	66°	7360	7360	69°	6490	6490	71°	6830	6830	70
75	64°	6840	6480	67°	6300	6300	69°	6530	6530	75
80	62°	6310	5520	65°	6280	6100	67°	6250	6250	80
85	60°	5840	4690	63°	5980	5210	65°	5980	5650	85
90	58°	5370	3960	61°	5540	4440	63°	5720	4830	90
95	55°	4940	3330	58°	5090	3760	60°	5470	4110	95
100	53°	4460	2760	56°	4670	3160	58°	5030	3470	100
105	50°	3870	2260	53°	4230	2620	55°	4500	2900	105
110	48°	3350	1800	50°	3670	2130	52°	3910	2380	110
115	45°	2880	1390	48°	3160	1690	49°	3380	1910	115
120	42°	2450	1020	45°	2700	1290	46°	2890	1470	120
125	39°	2050		42°	2280	920	43°	2440	1080	125
130	36°	1690		38°	1890		39°	2020		130
135	32°	1360		34°	1530		35°	1630		135
140	28°	1050		30°	1190		30°	1260		140
145										145
150										150

**CODES 180, 189, 198,  
207, 216, 225**  
**FIXED 30' JIB**

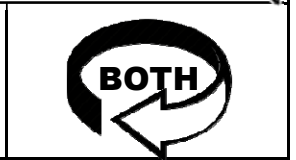
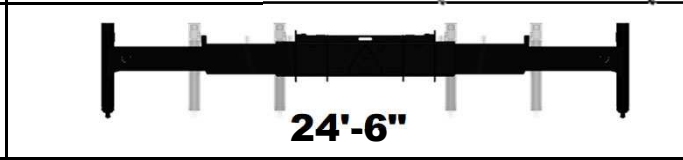
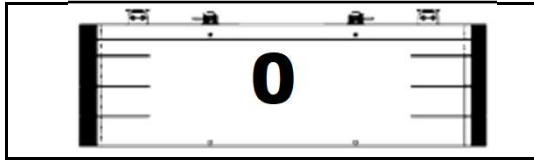
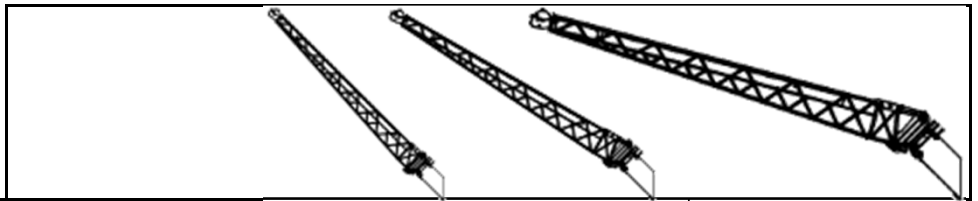

LOAD RADIUS (FT)	0° OFFSET			15° OFFSET			30° OFFSET			LOAD RADIUS (FT)
	BOOM ANGLE (DEG)	CODE 207	CODE 180	BOOM ANGLE (DEG)	CODE 216	CODE 189	BOOM ANGLE (DEG)	CODE 225	CODE 198	
		OVER REAR (LBS)	FULL 360° (LBS)		OVER REAR (LBS)	FULL 360° (LBS)		OVER REAR (LBS)	FULL 360° (LBS)	
6										6
8										8
10										10
12										12
15										15
20										20
25										25
30										30
35	79°	9000	9000							35
40	77°	9000	9000	79°	9000	9000				40
45	75°	9000	9000	78°	8580	8580				45
50	74°	8780	8780	76°	8130	8130	79°	7680	7680	50
55	72°	8520	8520	74°	7680	7680	77°	7590	7590	55
60	70°	8190	8190	73°	7260	7260	75°	7510	7510	60
65	68°	7760	7760	71°	6870	6870	73°	7160	7160	65
70	66°	7360	7180	69°	6490	6490	71°	6830	6830	70
75	64°	6840	6090	67°	6300	6300	69°	6530	6530	75
80	62°	6310	5150	65°	6280	5730	67°	6250	6220	80
85	60°	5840	4350	63°	5980	4870	65°	5980	5310	85
90	58°	5370	3640	61°	5540	4120	63°	5720	4510	90
95	55°	4840	3020	58°	5090	3460	60°	5470	3810	95
100	53°	4210	2480	56°	4590	2870	58°	4900	3190	100
105	50°	3640	1990	53°	3990	2350	55°	4260	2630	105
110	48°	3120	1550	50°	3440	1870	52°	3680	2120	110
115	45°	2660	1150	48°	2950	1450	49°	3160	1660	115
120	42°	2240		45°	2500	1060	46°	2680	1240	120
125	39°	1850		42°	2080		43°	2240	860	125
130	36°	1500		38°	1700		39°	1830		130
135	32°	1170		34°	1350		35°	1450		135
140	28°	870		30°	1020		30°	1090		140
145										145
150										150