

Technische Daten Raupenkran

LR 1300
Litronic®

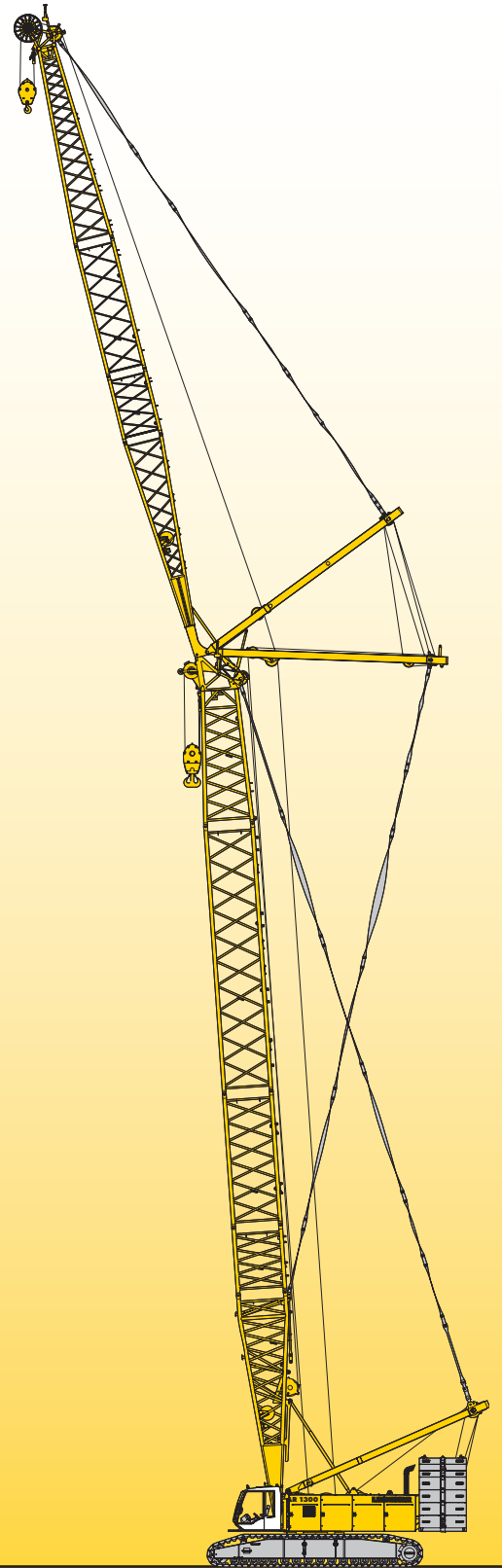

LIEBHERR

Courtesy of Crane.Market

Abmessungen

Grundgerät mit Unterwagen

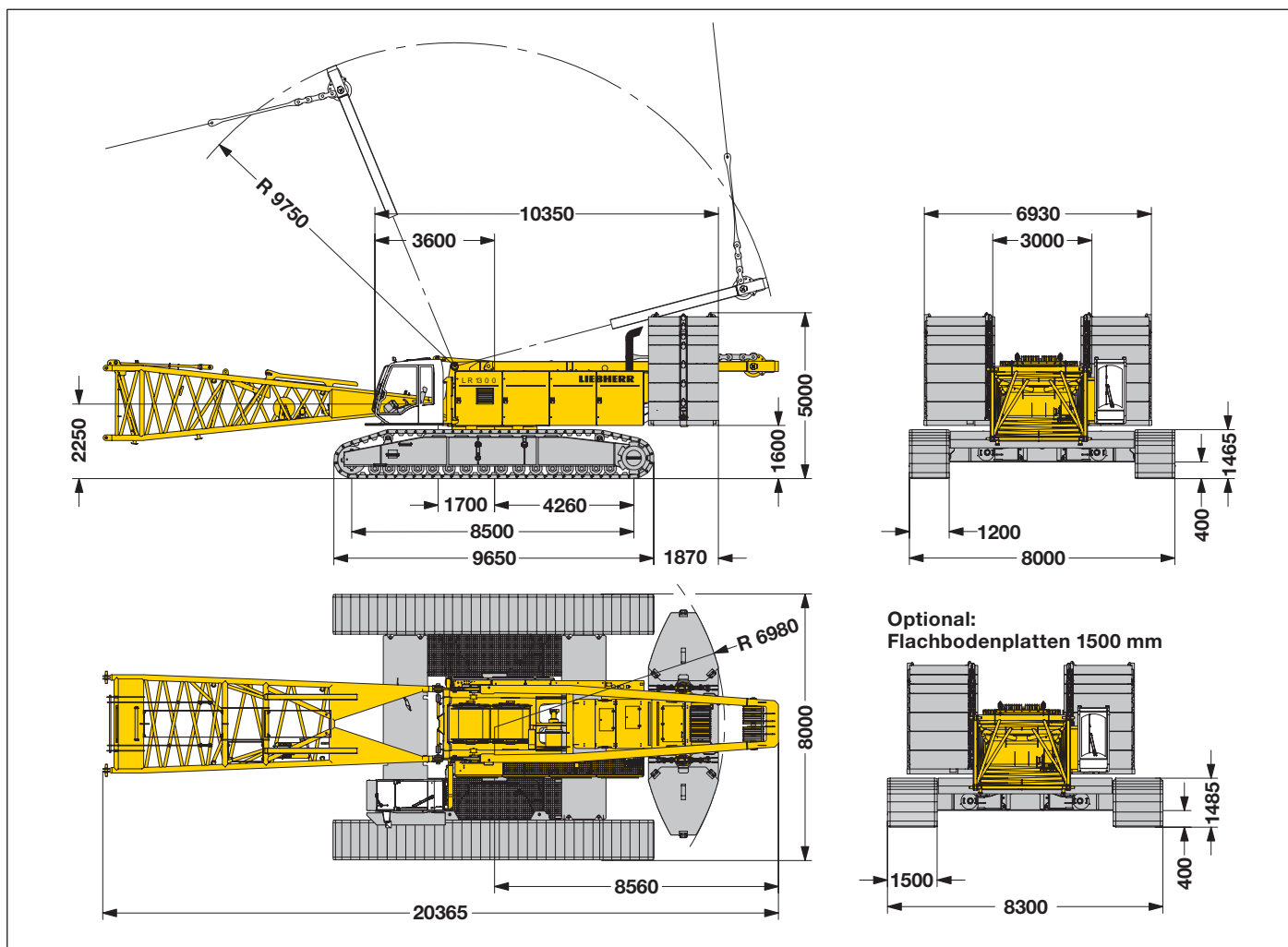

Dienstgewichte

Die Dienstgewichte beinhalten das Grundgerät mit Plattenlaufwerk, 2 Hauptwinden 150 kN und 20 m Hauptausleger, bestehend aus Aufrichtmast, Anlenkstück (10 m), Auslegerkopf (7 m), Auslegerzwischenstück (3 m), 124 t Oberwagenballast, 57 t Zentralballast und 300 t Hakenflasche.

Gesamtgewicht _____ ca. 290 t

Bodenbelastung

Bodenbelastung _____ 1.45 kg/cm²

Ausrüstung

Hauptausleger (No. 2821.xx) max. Länge _____ 98 m
 Leichtausleger (No. 2821.xx und 2316.xx) _____ 123 m
 Verstellbarer Nadelausleger (No. 2316.xx) max. Länge _____ 113 m
 Max. Kombination — Hauptausleger _____ 59 m
 — Verstellbarer Nadelausleger _____ 113 m
 Spitzenausleger _____ 36 t

Anmerkungen

1. Traglasten für Einsatz als Montagekran (entspricht Kraneinstufung nach F.E.M. 1.001. Krangruppe A1).
2. Die Maschine steht auf tragfähigem, waagrechtem Untergrund.
3. Das Gewicht des Lastaufnahmemittels (Hakenflasche, Hubseile, Schäkel usw.) ist von der Traglast abzuziehen.
4. Zusatzlasten am Ausleger (wie z.B. Podeste) sind von den Traglasten abzuziehen.
5. Die maximal zulässige Windgeschwindigkeit entnehmen Sie bitte dem Traglasttabellenbuch.
6. Die Ausladungen sind von Mitte Drehkranz und unter Last angegeben.
7. Die Traglasten sind in Tonnen angegeben und 360° schwenkbar.
8. Desweiteren sind für die Berechnung der Standsicherheit die DIN 15019 / Teil 2 / Tab. 1 und ISO 4305 Tab. 1 + 2, als auch die Kippwinkelmethode 4° zugrunde gelegt.
9. Für die Stahltragwerke gilt F.E.M. 1.001 - 1998 (EN 13001-1; EN 13001-2).

Transportmaße und Gewichte

Grundgerät und Hauptausleger (No. 2821.xx)

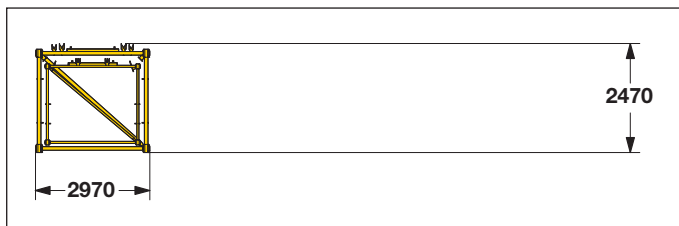
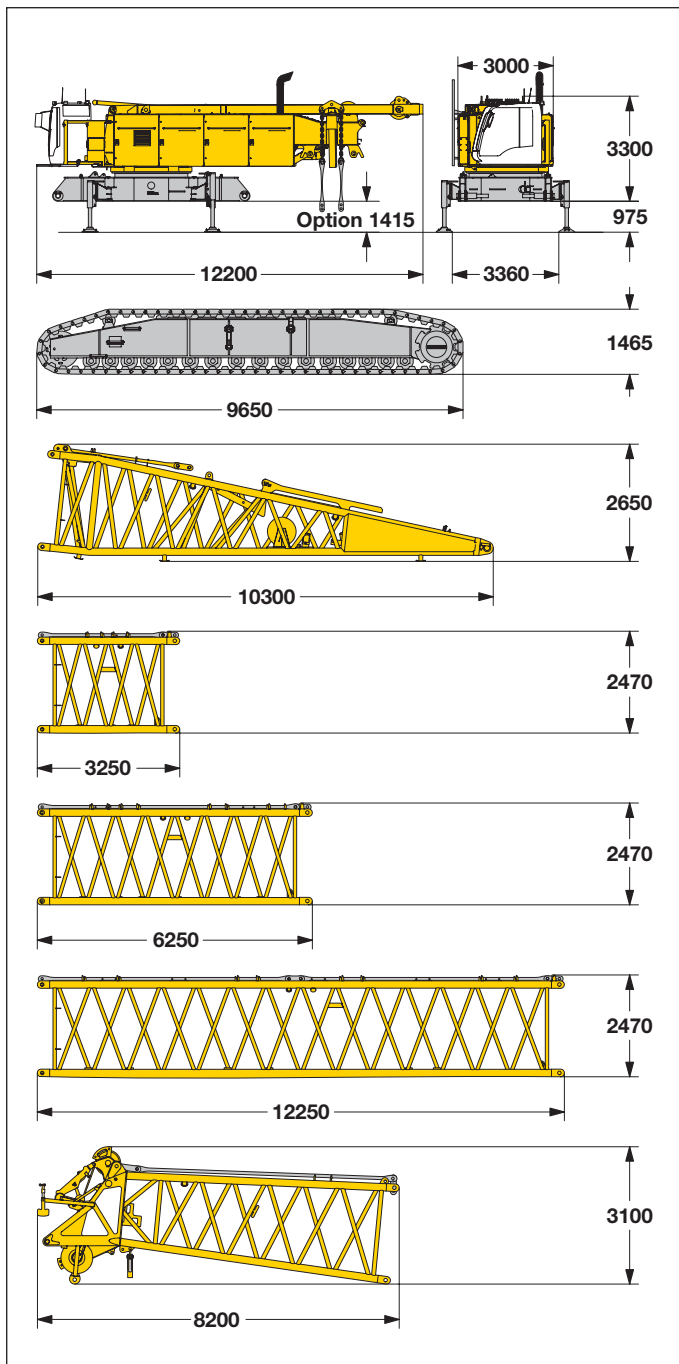

*) Inklusive Haltestangen

Grundgerät

mit Aufrichtmast, 2x 150 kN Kranwinden, ohne Anlenkstück, ohne Hubseile, Grundballast und Laufwerke

Breite	3000 mm
Gewicht	41800 kg

Laufwerk

2x

	Optional	Standard
Flachbodenplatten	1500 mm	1200 mm
Breite	1500 mm	1400 mm
Gewicht	26200 kg	22350 kg

Anlenkstück (No. 2821.30)

Breite	2970 mm
Gewicht ohne Winden	5700 kg
Gewicht inkl. Winde und Seil	7400 kg

Zwischenstück (No. 2821.24)

3 m

Breite	2970 mm
Gewicht*	1200 kg

Zwischenstück (No. 2821.24)

6 m

Breite	2970 mm
Gewicht*	1900 kg

Zwischenstück (No. 2821.24)

12 m

Breite	2970 mm
Gewicht*	3350 kg

Auslegerkopf (No. 2821.24)

Breite	2970 mm
Gewicht*	5400 kg

Transportalternative

No. 2821.xx/2316.xx	12/12	6/6	3/3 m
Länge	12500	6250	3250 mm
Gewicht*	5150	2850	1810 kg

Transportmaße und Gewichte

Verstellbarer Nadelausleger (No. 2316.xx)

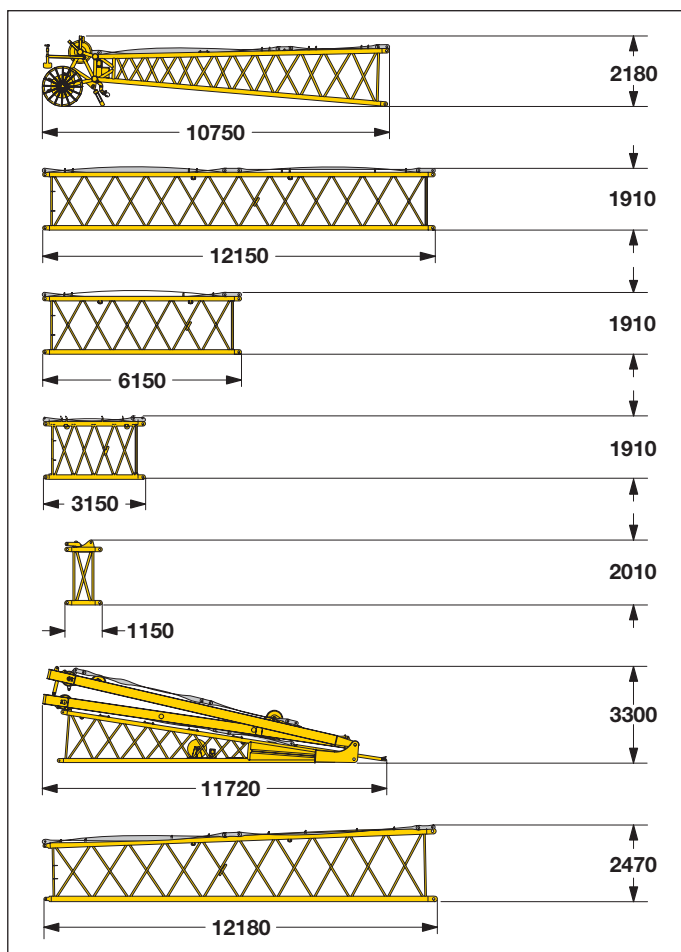

Nadelkopf (No. 2316.20)

Breite	2430 mm
Gewicht*	2300 kg

Zwischenstück (No. 2316.20) **12 m**

Breite	2430 mm
Gewicht*	1800 kg

Zwischenstück (No. 2316.20) **6 m**

Breite	2430 mm
Gewicht*	950 kg

Zwischenstück (No. 2316.20) **3 m**

Breite	2430 mm
Gewicht*	600 kg

Leichtausleger-Z-Stück (No. 2316.20) **1 m**

Breite	2430 mm
Gewicht*	640 kg

Anlenkstück mit A-Böcken (No. 2316.22)

Breite	2670 mm
Gewicht*	8060 kg

Leichtausleger-Reduzierstück (No. 2821/2316.24) **12 m**

Breite	2970 mm
Gewicht*	2700 kg

Verstellbarer Nadelausleger (No. 1916.xx)

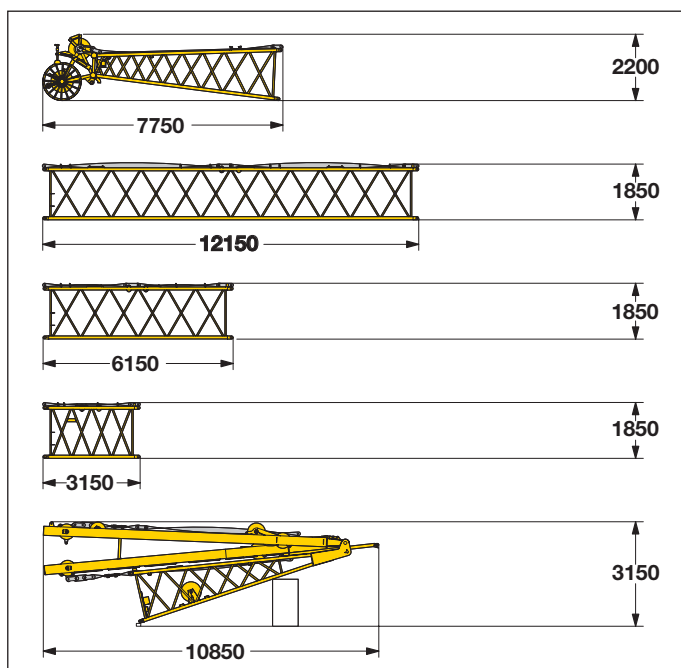

Nadelkopf (No. 1916.21)

Breite	2010 mm
Gewicht*	1550 kg

Zwischenstück (No. 1916.18) **12 m**

Breite	2010 mm
Gewicht*	1250 kg

Zwischenstück (No. 1916.18) **6 m**

Breite	2010 mm
Gewicht*	690 kg

Zwischenstück (No. 1916.18) **3 m**

Breite	2010 mm
Gewicht*	475 kg

Anlenkstück mit A-Böcken (No. 1916.22)

Breite	2010 mm
Gewicht*	6300 kg

*) Inklusiv Haltestangen

Transportmaße und Gewichte

Feststehender Nadelausleger (No. 1713.xx)

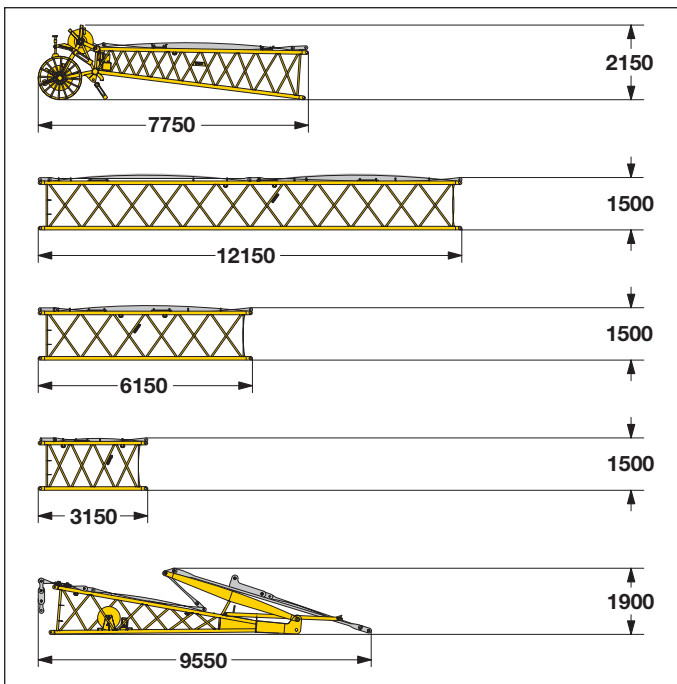

Nadelkopf (No. 1713.21)

Breite	1820 mm
Gewicht*	1375 kg

Zwischenstück (No. 1713.18) 12 m

Breite	1820 mm
Gewicht*	1140 kg

Zwischenstück (No. 1713.18) 6 m

Breite	1820 mm
Gewicht*	630 kg

Zwischenstück (No. 1713.18) 3 m

Breite	1820 mm
Gewicht*	420 kg

Anlenkstück mit A-Bock (No. 1713.22)

Breite	2450 mm
Gewicht*	2485 kg

Feststehender Nadelausleger (No. 1008.xx)

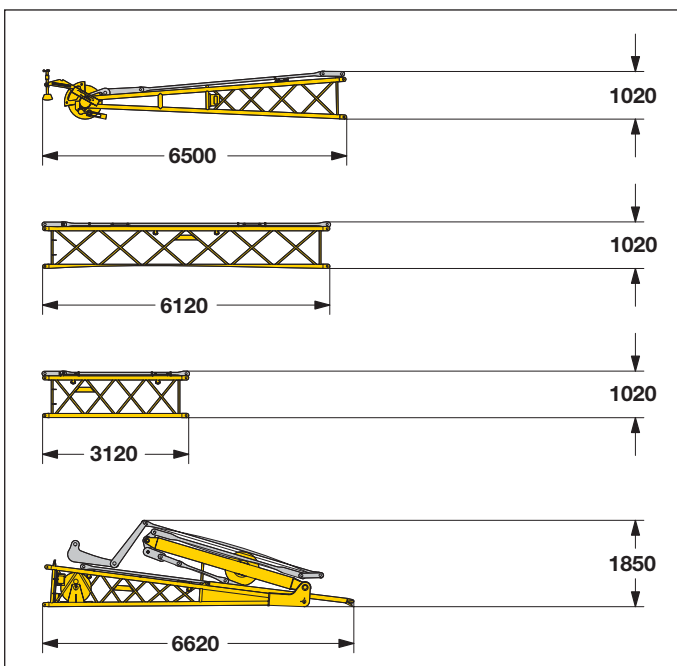

Nadelkopf (No. 1008.20)

Breite	1090 mm
Gewicht*	920 kg

Zwischenstück (No. 1008.17) 3 m

Breite	1090 mm
Gewicht*	630 kg

Zwischenstück (No. 1008.17) 6 m

Breite	1090 mm
Gewicht*	300 kg

Anlenkstück mit A-Bock (No. 1008.20)

Breite	2200 mm
Gewicht*	1950 kg

Transportmaße und Gewichte

Ballaste

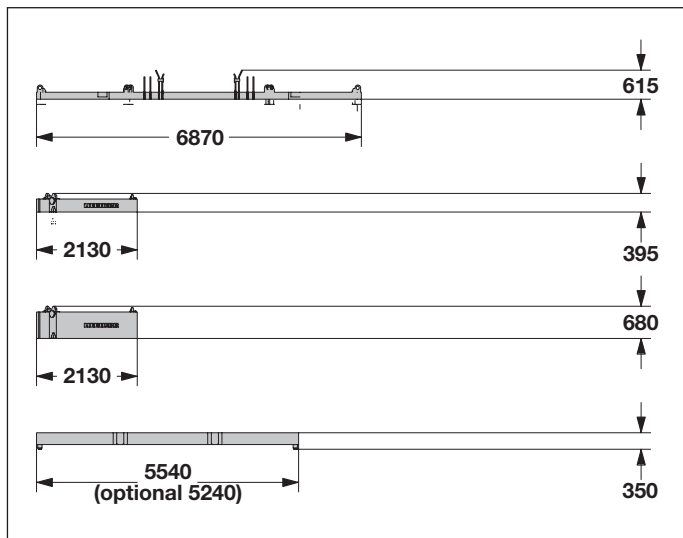

Ballastplatte **1x**

Breite	2110 mm
Gewicht	14500 kg

Ballastplatte **6x**

Breite	2110 mm
Gewicht	5000 kg

Ballastplatte **8x**

Breite	2110 mm
Gewicht	10000 kg

Zentralballastplatte **4x**

	Optional	Standard
Breite	1500 mm	1200 mm
Gewicht	13400 kg	14250 kg

Mid fall (optional)

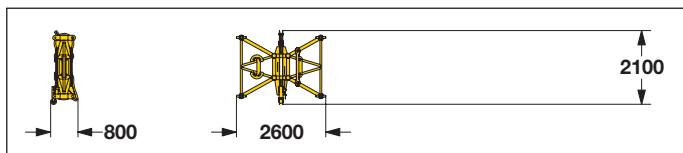

Mid fall Zwischenstück (No. 2316.25) **0.5 m**

Breite	800 mm
Gewicht	690 kg

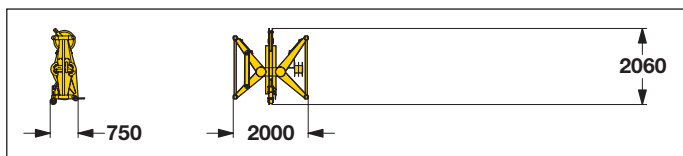

Mid fall Zwischenstück (No. 1916.32) **0.5 m**

Breite	750 mm
Gewicht	685 kg

Haken

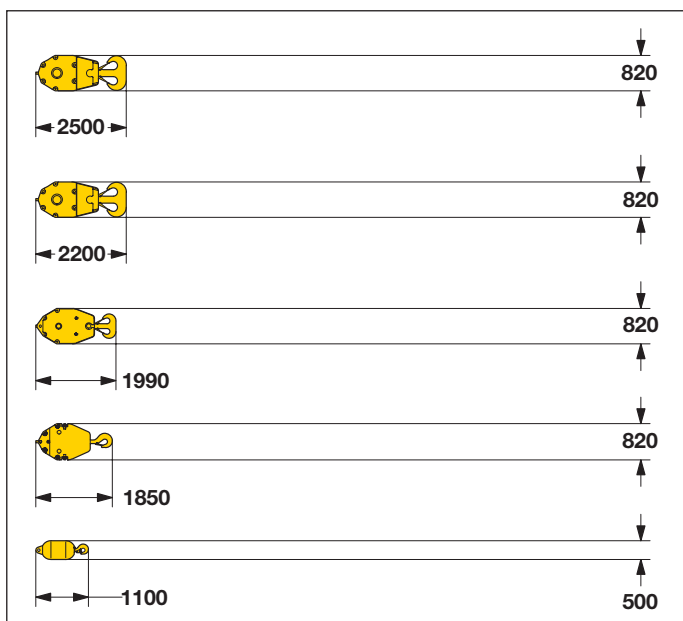

300 t Hakenflasche - 11 Rollen

Breite	880	1230 mm
Gewicht	3200	5500 kg

150 t Hakenflasche - 5 Rollen

Breite	500	660	820 mm
Gewicht	1600	2800	4000 kg

100 t Hakenflasche - 3 Rollen

Breite	340	480	620 mm
Gewicht	1100	2050	3000 kg

50 t Hakenflasche - 1 Rolle

Breite	280	410	540 mm
Gewicht	800	1600	2400 kg

16 t Einzelhaken

Breite	500 mm
Gewicht	900 kg

Technische Beschreibung



Motor

Leistung nach ISO 9249, 450 kW (612 PS) bei 1900 U/min
Modell ————— Liebherr D 9508 A7
Kraftstofftank ————— 900 l Tankinhalt mit kontinuierlicher
Niveauanzeige und Reserveangabe
Der Dieselmotor entspricht der Abgaszertifizierung für mobile
Maschinen nach EPA / CARB Tier 3 und 97/68 EG Stufe III.



Hydraulikanlage

Eine doppelte Verstellpumpe versorgt die Haupt- und Nadelausleger-
Verstellwinden und das Fahrwerk im offenen Kreislauf. Die
Haupthubwinden und das Drehwerk werden im geschlossenen
Kreislauf betrieben. Alle Bewegungen können gleichzeitig gefahren
werden. Um hydraulische Druckspitzen abzufangen, wurde eine
automatisch arbeitende Druckabschneidung integriert.
Alle Filter werden elektronisch überwacht.
Die Verwendung synthetischer, umweltfreundlicher Öle ist möglich.
Arbeitsdruck ————— max. 350 bar
Hydrauliköl-Tankinhalt - 900 l



Nadelausleger-Verstellwinde

Seilzug ————— max. 105 kN
Seildurchmesser ————— 20 mm
Verstellung Nadelausleger von 15° bis 78° in 69 sec.



Hauptausleger-Verstellwinde

Seilzug ————— max. 217 kN
Seildurchmesser ————— 24 mm
Verstellung Hauptausleger von 15° bis 86° in 127 sec.



Schwenkwerk

Rollendrehkranz mit außenliegender Verzahnung, Schwenkwerk
mit Axialkolbenmotor, hydraulisch löfzbare Lamellenbremse,
Planetengetriebe und Drehwerksritzel.
Das Schwenkwerk kann sowohl mit Geschwindigkeitsvorwahl wie
auch im Freilauf betrieben werden.
Bei der Geschwindigkeitsvorwahl schließt eine Lamellenbremse
(Stillstandsbremse), wenn keine Drehbewegung vorhanden ist.
Drehwerksgeschwindigkeit 0 – 1.8 U/min stufenlos regelbar.



Windwerke

Seilzug in der 1. Lage ————— max. 215 kN
Seilzug in der 7. Lage ————— 150 kN
Seildurchmesser ————— 28 mm
Seiltrommeldurchmesser ————— 730 mm
Seilgeschwindigkeit m/min ————— 0 – 138
Seilkapazität in 7 Lagen ————— 570 m

Die Winden zeichnen sich durch ihre kompakte, montagefreundliche
Bauweise aus.

In Öl laufende, innenliegende, wartungsarme Planetengetriebe.
Lastabstützung über Hydraulikanlage, zusätzliche Sicherheit durch
federbelastete Lamellenbremse (Stillstandsbremse).
Für die Hauptwinden werden hochdruckgeregelter Verstellölmotoren
verwendet. Diese erlauben schon im Teillastbereich die volle
Ausnutzung der installierten Motorleistung durch Geschwindigkeits-
anpassung an den jeweiligen Seilzug.
Auf Wunsch – Winde mit Freifalleinrichtung:
Bei der Freifalleinrichtung wird sowohl die Kupplungs- als auch die
Bremsfunktion über die Arbeitsbremse realisiert. Diese Bremse ist
eine verschleißarme, wartungsfreie Lamellenbremse in kompakter
Bauweise.



Fahrwerk

Fahrwerksantrieb mit Axialkolbenmotor, hydraulisch löfzbare, feder-
belastete Lamellenbremse, Laufwerk mit hydraulischer Ketten-
spannung.
Flachbodenplatten — 1200 mm (optional 1500 mm)
Fahrgeschwindigkeit — 0 – 1.3 km/h



Steuerung

Die von Liebherr entwickelte und im eigenen Haus gefertigte Steuerung
ist für den harten Baustelleneinsatz und extreme Umweltbedingungen
wie große Temperaturschwankungen, starke Vibrationen und
elektromagnetische Interferenzen konzipiert.

Alle Betriebsdaten des Gerätes werden auf einem kontraststarken
Bildschirm angezeigt.
Standard-Betriebsinformationen erscheinen in Form von Symbolen,
Fehleranzeigen im Klartext auf dem Bildschirm (mehr als 15 Sprachen
verfügbar).

Eine elektrohydraulische, stufenlose Proportionalsteuerung ermöglicht
das Fahren aller Bewegungen gleichzeitig.

Die Bedienung erfolgt über 2 Einhebel-Kreuzschaltungen für „Winde I
und Einziehwerk“ und für „Winde II und Drehwerk“.

Auf Wunsch:

Doppel-T-Hebel für den gleichzeitigen Betrieb von Winde und
verstellbarem Nadelausleger.

Das Fahrwerk wird über zwei Fußpedale gesteuert und kann über zwei
Hebel in eine Hand-Fahrwerkssteuerung umgewandelt werden.

Fernsteuerung für die Heckballastmontage und für die Verbolzung des
Auslegeranlenkstückes mit dem Oberwagenstahlbau.



Schallemission

Die Schallemissionen entsprechen der Richtlinie 2000/14/EG über
Geräuschemissionen von zur Verwendung im Freien vorgesehenen
Geräten und Maschinen.

Auslegerkombinationen

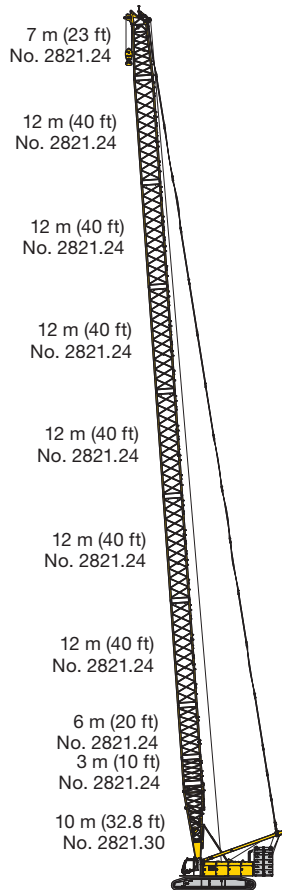

Hauptausleger No.2821.xx — 98 m

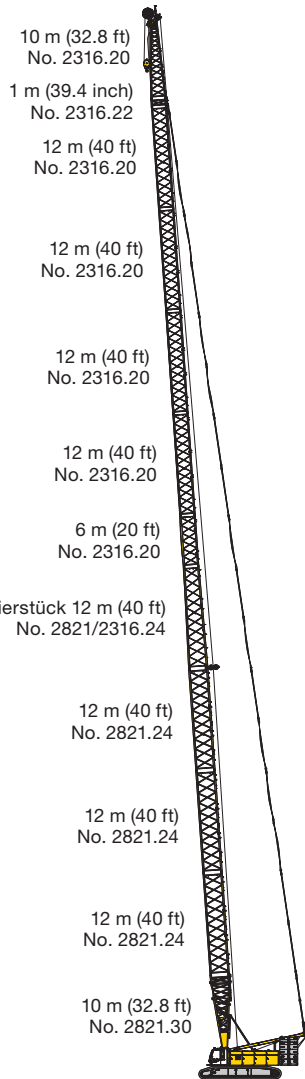

Max. Kombination — 123 m
 Hauptausleger No.2321.xx 46 m
 Reduzierung No.2821/2316.xx 12 m
 Verstellbarer Nadelausleger No.2316.xx 65 m

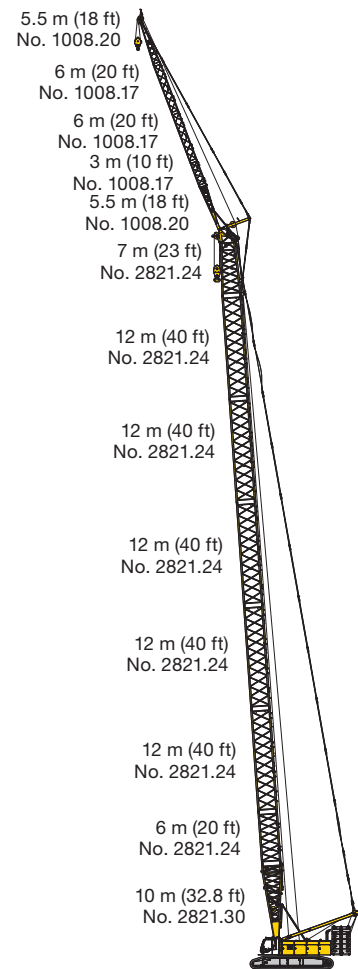

Max. Kombination — 109 m
 Hauptausleger No. 2821.xx - 83 m
 Feststehender Nadelausleger No. 1008.xx - 26 m

Selbstmontage-System

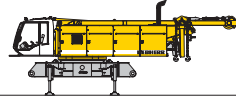
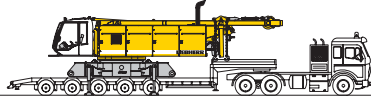
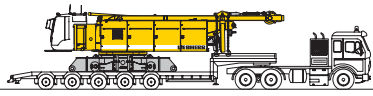

Entladung des Grundgerätes

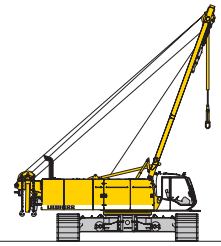
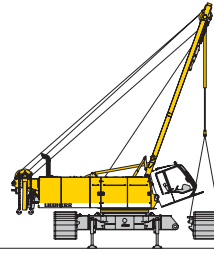
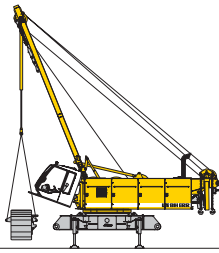
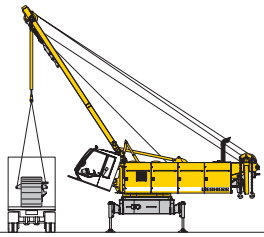

Entladung und Anbau der Laufwerke

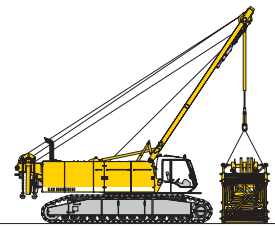
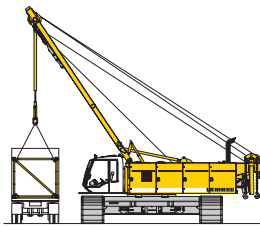
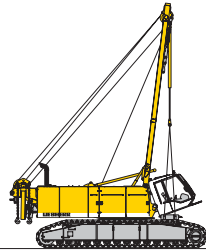
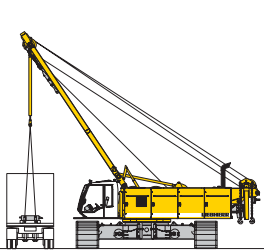

Entladung und Anbau des Zentralballastes

Entladung und Zusammenbau des Auslegers

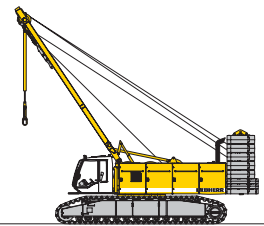
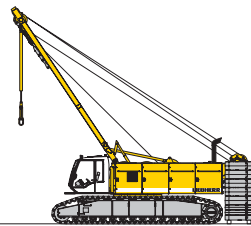
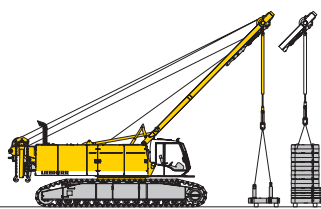
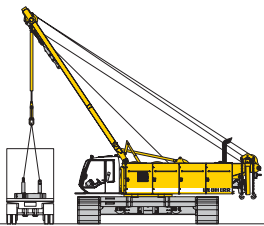

Entladung, Zusammen- und Anbau des Gegengewichtes

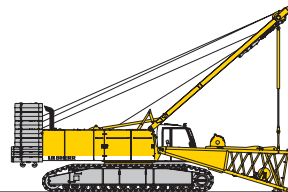
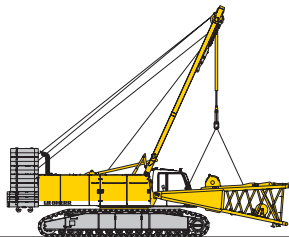
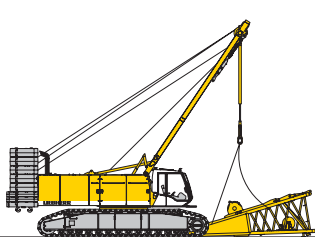

Entladung und Anbau des Auslegeranlenkstücks

Ausleger aufrichten - Kran in Arbeitsposition

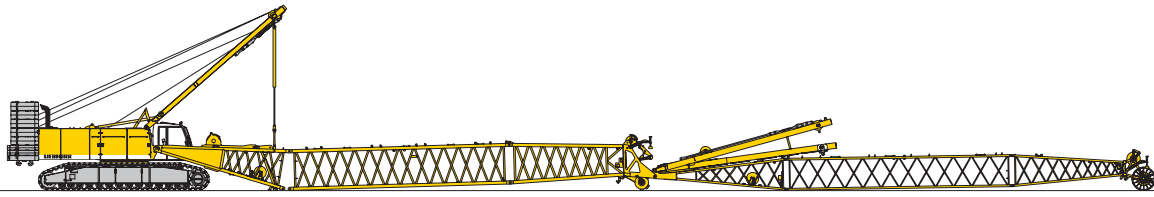

Anbau des Auslegers

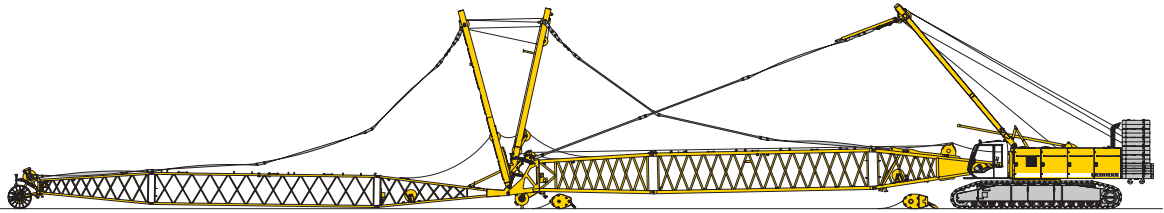

Einziehen der Hub- und Nadelseile

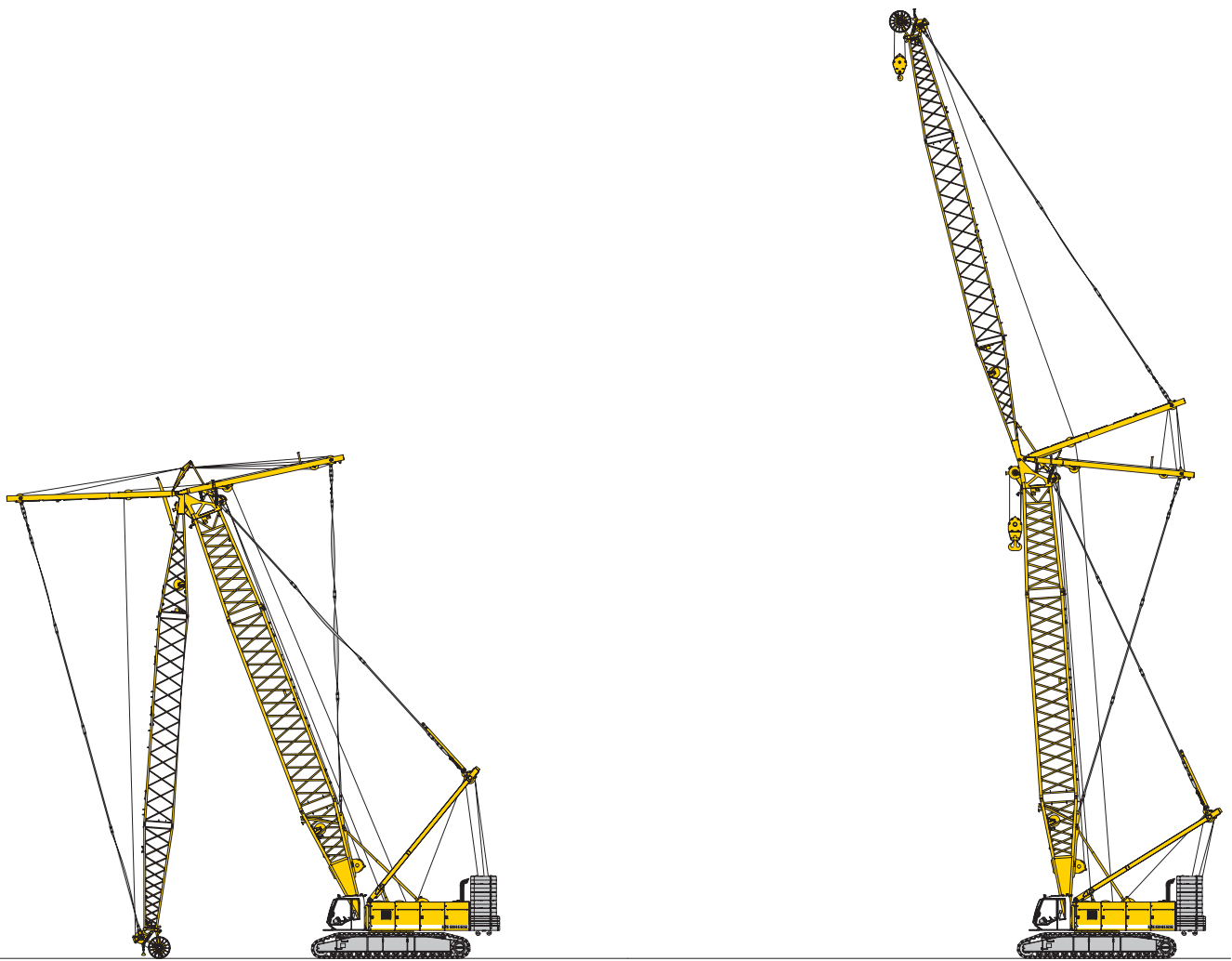

Haupt- und Nadelausleger anheben

Kran in Arbeitsposition

Hauptausleger (No. 2821.xx) 86° - 15°

124 t Ballast und 57 t Zentralballast

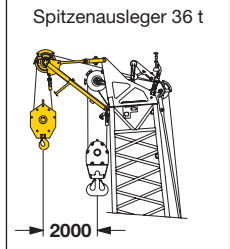
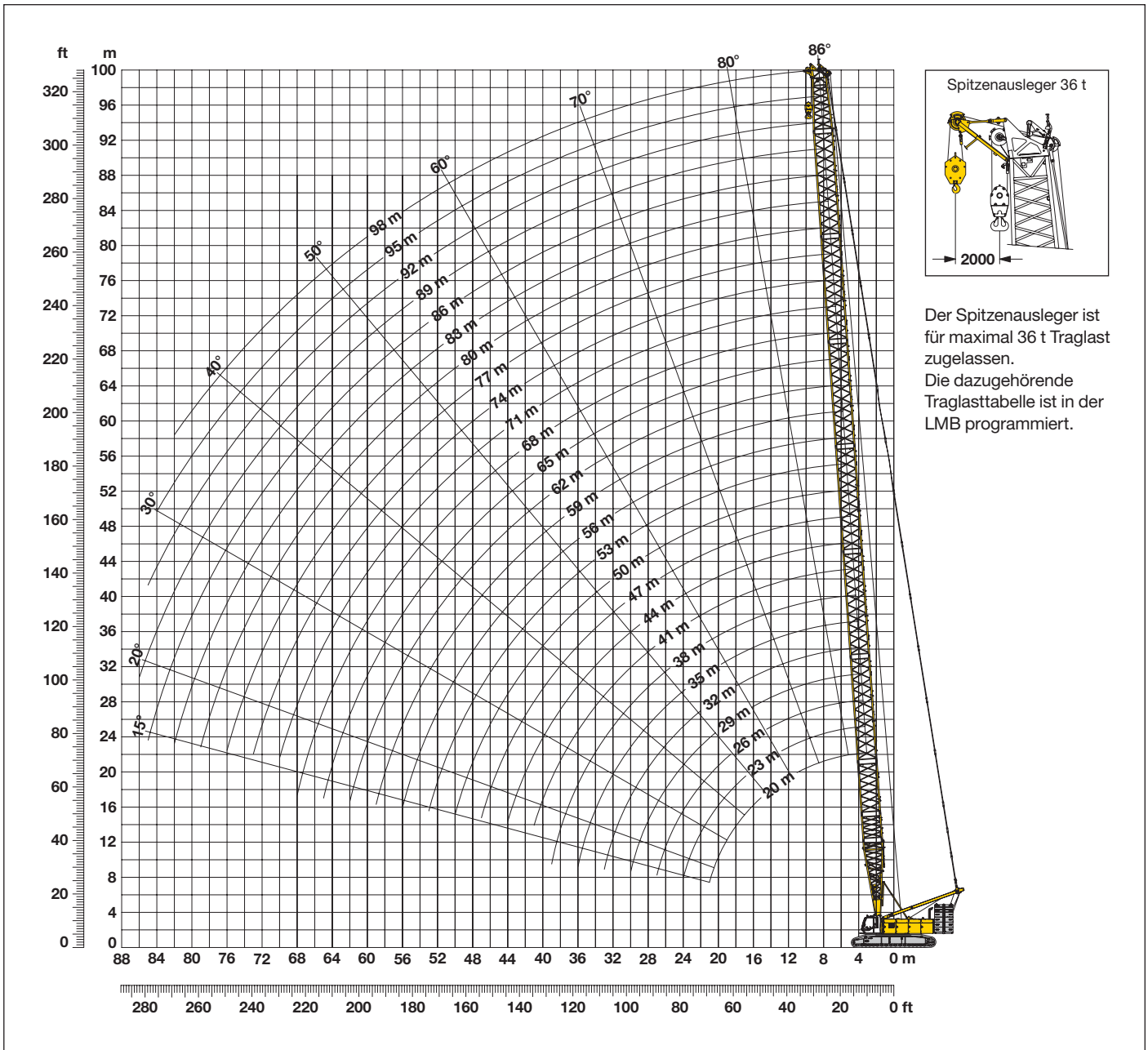

Der Spitzenausleger ist für maximal 36 t Traglast zugelassen.
Die dazugehörige Traglasttabelle ist in der LMB programmiert.

Hauptausleger-Zusammenbau (Tabelle 1 – No. 2821.xx)

Hauptausleger-Zusammenbau für Auslegerlängen von 20 m bis 98 m

Anlenkstück	Länge	Anzahl der Auslegerstücke																										
		20	23	26	29	32	35	38	41	44	47	50	53	56	59	62	65	68	71	74	77	80	83	86	89	92	95	98
Anlenkstück	10 m	1	1	1	1	1	1	1	1	1	1	1	1	1	1	1	1	1	1	1	1	1	1	1	1	1	1	1
Z-Stück	3 m	1		1		1		1		1		1		1		1		1		1		1		1		1		1
Z-Stück	6 m		1	1		1	1	1		1	1		1	1		1	1		1	1		1	1		1	1		1
Z-Stück	12 m			1	1	1	1	1	2	2	2	2	3	3	3	3	4	4	4	4	5	5	5	5	6	6	6	6
Kopfstück	7 m	1	1	1	1	1	1	1	1	1	1	1	1	1	1	1	1	1	1	1	1	1	1	1	1	1	1	1
Auslegerlänge (m)		20	23	26	29	32	35	38	41	44	47	50	53	56	59	62	65	68	71	74	77	80	83	86	89	92	95	98

Traglasten Hauptausleger (No. 2821.xx)

104 t Ballast und 57 t Zentralballast

Radius (m)	Auslegerlänge (m)															Radius (m)
	20	23	26	32	38	44	50	56	62	68	74	80	86	92	95	
4.3	286.2	t	t	t	t	t	t	t	t	t	t	t	t	t	t	4.3
5	286.2	300.5	296.8													5
6	258.4	259.3	257.5	245.6	237.4	212.6										6
7	225.6	225.6	222.7	216.1	207.6	198.5	189.6	169.5								7
8	196.1	196.0	195.7	191.4	185.2	179.2	169.5	162.2	150.4	127.8						8
9	173.1	173.0	172.7	172.4	166.5	161.0	153.6	145.9	138.9	125.7	109.1	97.2	83.6			9
10	154.6	154.6	154.3	154.0	151.6	144.3	137.4	131.1	125.1	118.3	104.7	96.5	83.6	73.1	67.8	10
14	107.2	107.2	106.9	106.7	103.4	99.4	95.6	92.0	88.6	85.3	82.1	79.1	74.8	67.7	63.2	14
16	89.3	89.5	89.4	89.5	88.7	85.6	82.5	79.6	76.8	74.1	71.4	68.9	66.4	62.2	59.0	16
18	75.7	76.0	75.9	76.0	75.7	74.9	72.3	69.9	67.4	65.2	62.9	60.7	58.6	56.5	54.5	18
20	65.4	65.7	65.7	65.7	65.4	65.2	64.1	62.0	59.9	57.9	55.9	54.0	52.1	50.3	49.4	20
24		51.0	51.1	51.2	50.9	50.6	50.2	49.8	48.4	46.8	45.2	43.7	42.1	40.6	39.8	24
26			45.7	45.9	45.6	45.3	44.8	44.5	44.0	42.5	41.0	39.6	38.1	36.7	36.0	26
32				34.2	34.0	33.8	33.3	32.9	32.4	31.9	31.4	30.2	29.0	27.8	27.2	32
38					26.3	26.2	25.8	25.4	24.8	24.4	23.8	23.3	22.5	21.5	21.0	38
44						20.7	20.4	20.0	19.5	19.0	18.5	18.0	17.4	16.8	16.2	44
50							16.3	16.0	15.5	15.1	14.6	14.1	13.5	13.0	12.7	50
55								13.4	13.0	12.5	12.0	11.5	10.9	10.4	10.1	55
60									10.7	10.3	9.8	9.3	8.7	8.2	7.9	60
65										8.5	8.0	7.5	6.9	6.4	6.1	65
70											6.4	5.9	5.3	4.8	4.6	70
75												4.6	4.0	3.4	3.0	75
80													2.6			80

Traglasten Hauptausleger (No. 2821.xx)

124 t Ballast und 57 t Zentralballast

Radius (m)	Auslegerlänge (m)															Radius (m)
	20	23	26	32	38	44	50	56	62	68	74	80	86	92	98	
6.8								169.5								6.8
8							169.5	162.2	150.4	127.8						8
9					166.5	161.0	155.0	147.0	139.3	125.7	109.1	97.2	83.6			9
10				156.8	152.7	146.4	140.8	135.7	128.8	118.3	104.7	96.5	83.6	73.1	63.7	10
12	136.9	136.9	134.9	133.1	127.8	124.7	120.3	114.9	110.0	105.1	96.1	90.9	79.5	70.8	62.7	12
14	115.7	115.7	115.4	113.1	110.9	107.0	103.6	100.4	95.6	90.8	84.1	82.3	74.8	67.7	59.8	14
16	99.7	99.8	99.5	98.5	96.1	94.4	90.6	87.3	84.2	80.7	75.1	72.7	67.4	62.2	57.0	16
18	86.0	86.2	86.2	86.2	84.7	83.1	80.9	77.2	74.4	71.5	67.9	65.8	61.7	57.1	52.6	18
20	74.3	74.7	74.7	74.7	74.4	74.0	72.1	69.6	66.7	63.9	60.9	59.2	56.8	53.2	49.0	20
22		65.6	65.6	65.7	65.4	65.1	64.7	63.0	60.8	57.9	55.1	53.4	51.3	48.8	46.3	22
24		58.2	58.3	58.4	58.1	57.9	57.4	57.0	55.4	53.1	50.5	48.6	46.5	44.4	42.1	24
26			52.3	52.4	52.1	51.9	51.4	51.1	50.6	48.7	46.5	44.8	42.6	40.6	38.5	26
32				39.4	39.2	39.0	38.5	38.1	37.6	37.1	36.6	35.5	33.8	32.2	30.4	32
38					30.6	30.5	30.0	29.7	29.1	28.7	28.1	27.6	27.0	25.9	24.6	38
44						24.4	24.0	23.7	23.2	22.7	22.1	21.6	21.1	20.5	19.6	44
50							19.5	19.2	18.7	18.2	17.7	17.2	16.6	16.1	15.5	50
55								16.2	15.8	15.3	14.8	14.3	13.8	13.2	12.6	55
60									13.4	13.0	12.4	11.9	11.3	10.8	10.2	60
65										10.9	10.4	9.9	9.3	8.7	7.9	65
70											8.6	8.1	7.4	6.7	5.9	70
75												6.3	5.6	5.0	4.2	75
80													4.1	3.4	2.7	80
85														2.7	2.1	85

Leichtausleger (No. 2821/2316.xx) **72 m - 123 m**

Arbeitsbereich 78° - 15°

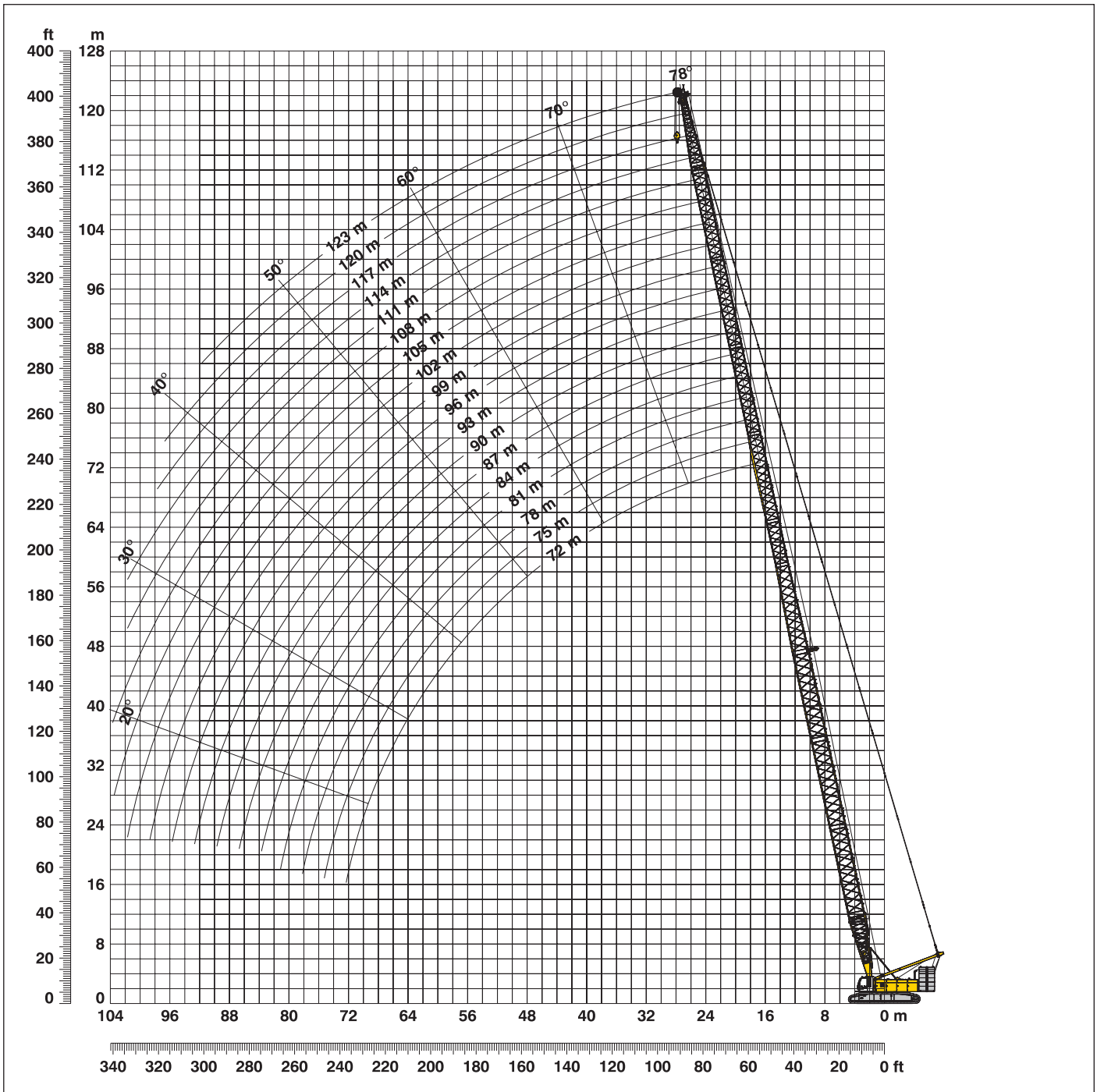

Leichtauslegerzusammenbau mit 46 m Hauptausleger (No. 2821/2316.xx)

Auslegerzusammenbau für Leichtauslegerlängen von 72 m bis 123 m

	Länge	Anzahl der Haupt- und Nadelauslegerstücke																	
Anlenkstück	10 m	1	1	1	1	1	1	1	1	1	1	1	1	1	1	1	1	1	1
Z-Stück	12 m	3	3	3	3	3	3	3	3	3	3	3	3	3	3	3	3	3	3
Reduzierstück	12 m	1	1	1	1	1	1	1	1	1	1	1	1	1	1	1	1	1	1
Nadel-Z-Stück	3 m	1		1		1		1		1		1		1		1		1	
Nadel-Z-Stück	6 m		1	1			1		1		1		1		1		1		1
Nadel-Z-Stück	12 m				1	1	1	1	2	2	2	2	3	3	3	3	4	4	4
Nadel-Z-Stück	1 m	1	1	1	1	1	1	1	1	1	1	1	1	1	1	1	1	1	1
Nadelkopf	10 m	1	1	1	1	1	1	1	1	1	1	1	1	1	1	1	1	1	1
Max. Auslegerlänge (m)		72	75	78	81	84	87	90	93	96	99	102	105	108	111	114	117	120	123

Traglasten - Leichtausleger (No. 2821/2316.xx)

Hauptausleger 46 m

Radius (m)	Leichtauslegerlängen (m)														Radius (m)	
	72	84	87	90	93	96	99	102	105	108	111	114	117	120		123
17.2	53.7	t	t	t	t	t	t	t	t	t	t	t	t	t	t	17.2
20	46.0	42.2														20
22	41.4	38.5	37.7	36.4	35.0											22
24	38.1	34.9	34.2	33.4	32.7	31.0	30.5	28.5								24
26	35.5	32.0	31.3	30.4	29.8	28.7	28.6	27.2	26.0	24.4	22.5	20.7				26
28	33.4	29.8	29.1	28.1	27.4	26.5	26.2	25.1	24.2	23.1	21.6	20.0	17.3	16.8	15.8	28
30	31.7	28.0	27.3	26.3	25.6	24.8	24.3	23.3	22.5	21.6	20.4	19.1	16.8	16.3	15.3	30
32	29.4	26.5	25.7	24.8	24.1	23.5	22.8	21.9	21.1	20.3	19.3	18.1	16.2	15.7	14.8	32
34	27.2	25.2	24.4	23.5	22.8	22.1	21.5	20.8	20.0	19.3	18.4	17.4	15.8	15.2	14.3	34
36	25.4	23.9	23.4	22.4	21.7	21.0	20.3	19.6	18.9	18.3	17.6	16.7	15.4	14.8	13.9	36
38	24.0	22.2	21.9	21.4	20.8	20.1	19.3	18.6	18.0	17.3	16.7	16.0	15.0	14.5	13.5	38
40	22.4	20.8	20.4	19.9	19.6	19.3	18.5	17.8	17.1	16.5	15.9	15.2	14.3	13.9	13.2	40
42	20.9	19.6	19.2	18.6	18.3	18.0	17.6	17.1	16.4	15.8	15.2	14.4	13.7	13.3	12.6	42
44	19.7	18.6	18.1	17.5	17.2	16.8	16.5	16.1	15.7	15.2	14.5	13.8	13.2	12.7	12.0	44
46	18.6	17.5	17.2	16.6	16.2	15.8	15.4	15.1	14.7	14.3	14.0	13.2	12.7	12.1	11.5	46
48	17.6	16.4	16.1	15.7	15.4	14.9	14.5	14.1	13.8	13.4	13.1	12.6	12.3	11.7	11.1	48
50	16.5	15.4	15.2	14.7	14.5	14.2	13.8	13.3	12.9	12.6	12.3	11.8	11.6	11.2	10.8	50
55	14.4	13.5	13.2	12.6	12.5	12.2	11.9	11.6	11.3	10.9	10.6	10.1	9.8	9.5	9.2	55
60	12.5	11.7	11.5	11.0	11.0	10.6	10.3	10.0	9.7	9.4	9.2	8.8	8.5	8.2	7.9	60
65	11.0	10.3	10.0	9.6	9.5	9.3	9.1	8.7	8.4	8.1	7.8	7.4	7.2	7.0	6.8	65
70	9.4	8.9	8.8	8.5	8.3	8.0	7.7	7.5	7.3	7.0	6.8	6.4	6.1	5.9	5.6	70
75		7.8	7.6	7.3	7.3	7.0	6.7	6.4	6.2	6.0	5.8	5.5	5.2	5.0	4.7	75
80		6.7	6.6	6.3	6.3	6.0	5.8	5.5	5.4	5.1	4.9	4.5	4.3	4.2	3.9	80
85			5.6	5.4	5.4	5.2	4.9	4.6	4.6	4.3	4.1	3.8	3.6	3.4	3.1	85
90					4.5	4.4	4.2	3.9	3.8	3.5	3.4	3.1	3.0	2.8	2.5	90
95							3.5	3.2	3.2	2.9	2.7	2.4	2.0	2.1		95
100								2.6	2.4	2.3	2.2					100

Verstellb. Nadelausleger (No. 2316.xx) 78° - 15°

Hauptausleger 88° - 45°

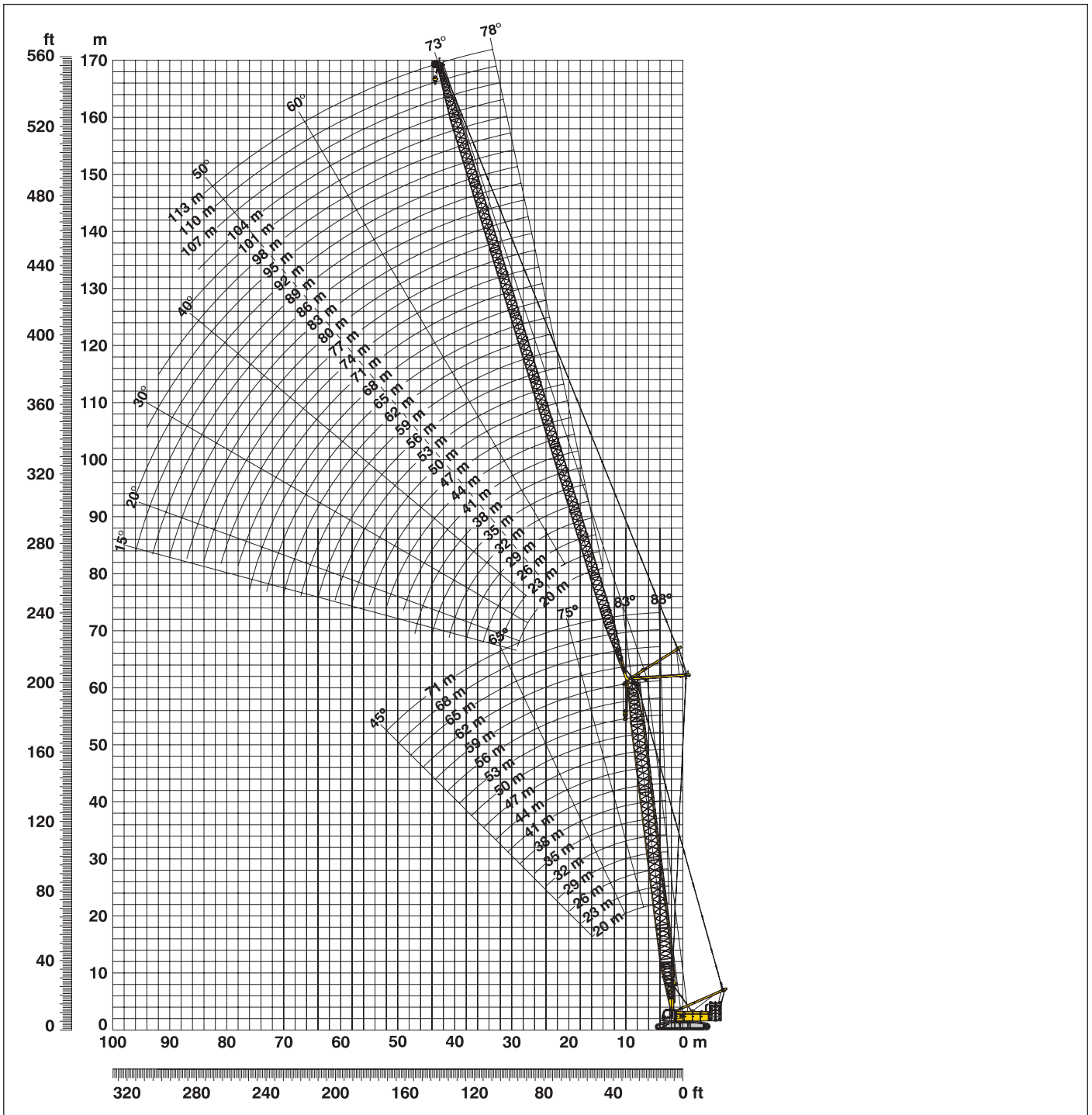

Auslegerzusammenbau für Hauptauslegerlängen von 20 m - 71 m – siehe Tabelle 1, Seite 12 Konfiguration mit verstellbarem Nadelausleger (20 m - 113 m)

	Länge	Anzahl der Nadelauslegerstücke																															
		20	23	26	29	32	35	38	41	44	47	50	53	56	59	62	65	68	71	74	77	80	83	86	89	92	95	98	101	104	107	110	113
Anlenkstück	10 m	1	1	1	1	1	1	1	1	1	1	1	1	1	1	1	1	1	1	1	1	1	1	1	1	1	1	1	1	1	1	1	1
Nadel-Z-Stück	3 m		1		1		1		1		1		1		1		1		1		1		1		1		1		1		1		1
Nadel-Z-Stück	6 m			1	1		1	1		1	1		1	1		1	1		1	1		1	1		1	1		1	1		1	1	
Nadel-Z-Stück	12 m				1	1	1	1	1	2	2	2	2	3	3	3	3	4	4	4	4	5	5	5	5	6	6	6	6	7	7	7	7
Kopfstück	10 m	1	1	1	1	1	1	1	1	1	1	1	1	1	1	1	1	1	1	1	1	1	1	1	1	1	1	1	1	1	1	1	
Nadellänge (m)		20	23	26	29	32	35	38	41	44	47	50	53	56	59	62	65	68	71	74	77	80	83	86	89	92	95	98	101	104	107	110	113

Traglasten - verstellb. Nadelausleger (No. 2316.xx)

Hauptausleger 88°

Hauptausleger 20 m

Radius (m)	Nadellänge (m)							
	20	41	53	65	77	89	101	113
12.4	t	t	t	t	t	t	t	t
15		68.7						
18	43.5	39.7	38.7	36.4				
20	36.9	33.6	32.4	31.7	26.4			
22	31.6	28.4	27.5	27.6	25.6			
24		25.5	24.4	23.4	22.0	18.0		
26		22.8	21.3	20.3	19.5	17.0	12.8	
28		20.7	19.2	18.2	17.1	16.0	12.6	9.1
32		17.5	16.2	14.8	14.5	12.8	12.0	8.7
36		14.9	13.9	12.6	11.4	10.5	9.3	8.0
42		12.1	11.2	9.7	8.7	7.5	6.7	5.6
50			8.5	7.3	6.1	5.1	4.1	3.5
55				6.2	5.0	3.9	3.0	2.5
65				4.4	3.4	2.6		
70					2.9	2.2		
75					2.4			

Hauptausleger 32 m

Radius (m)	Nadellänge (m)							
	20	41	53	65	77	89	101	113
12.8	t	t	t	t	t	t	t	t
13		71.8						
16	86.9	71.8						
18	65.2	61.7	50.2					
22	55.1	51.9	47.5	34.8				
24	40.6	38.1	36.5	32.7	24.5			
26		33.5	32.3	29.9	23.6	17.0		
28		30.3	28.8	27.0	22.8	16.5	12.1	
32		27.5	26.1	24.9	21.6	16.2	11.9	8.5
36		23.6	22.1	20.8	19.8	15.4	11.4	8.2
42		20.5	19.1	18.0	16.6	14.7	10.8	7.8
55		17.2	15.8	14.5	13.4	11.7	9.9	7.2
65			11.0	9.8	8.6	7.3	6.3	5.0
70				7.4	6.2	5.1	3.9	3.1
75					5.4	4.1	3.1	2.2
85					4.6	3.3	2.3	

Hauptausleger 41 m

Radius (m)	Nadellänge (m)							
	20	41	53	65	77	89	101	113
8.8	t	t	t	t	t	t	t	t
14	117.0							
16	74.3	66.2						
19	61.8	57.0	46.7					
22	48.7	45.1	42.0	32.7				
24	39.4	36.1	34.0	30.7	23.3			
26		31.9	30.3	28.3	22.4	16.1		
30		28.9	27.2	25.3	21.8	15.8	11.5	
34		24.4	22.9	21.3	19.1	15.1	11.2	8.1
38		21.2	19.6	18.2	16.7	14.0	10.7	7.7
44		18.7	17.2	15.9	14.3	12.8	10.2	7.3
55		14.5	14.3	13.0	11.7	10.1	8.8	6.8
65			10.7	9.4	8.2	6.8	5.8	4.5
70				7.2	5.9	4.7	3.6	3.0
75					5.1	3.8	2.8	2.4
80					4.4	3.1	2.1	

Hauptausleger 53 m

Radius (m)	Nadellänge (m)							
	20	41	53	65	77	89	101	113
9.2	t	t	t	t	t	t	t	t
14	95.0							
16	65.6	55.3						
19	55.8	49.2	41.2					
22	44.7	40.0	36.8	29.0				
24	36.7	32.9	30.3	26.9	20.5			
28	15.1	29.3	27.2	24.8	20.0	14.7		
30		24.5	22.6	20.5	17.9	14.3	10.6	
36		22.7	21.0	18.9	16.6	14.0	10.5	7.4
40		18.6	17.0	15.3	13.4	11.8	9.5	7.0
44		16.7	15.1	13.4	11.6	10.3	8.7	6.5
55		15.0	13.4	11.8	10.3	8.9	7.7	6.0
65			10.1	8.6	7.2	6.0	4.9	3.6
70				6.6	5.3	4.2	3.0	
75					4.6	3.4	2.3	
80					3.9	2.7		

Hauptausleger 59 m

Radius (m)	Nadellänge (m)						
	20	41	53	65	77	89	101
9.2	t	t	t	t	t	t	t
14	95.0						
16	65.6	55.3					
19	55.8	49.2	41.2				
22	44.7	40.0	36.8	29.0			
24	36.7	32.9	30.3	26.9	20.5		
28	15.1	29.3	27.2	24.8	20.0	14.7	
30		24.5	22.6	20.5	17.9	14.3	10.6
36		22.7	21.0	18.9	16.6	14.0	10.5
40		18.6	17.0	15.3	13.4	11.8	9.5
44		16.7	15.1	13.4	11.6	10.3	8.7
55		15.0	13.4	11.8	10.3	8.9	7.7
65			10.1	8.6	7.2	6.0	4.9
70				6.6	5.3	4.2	3.0
75					4.6	3.4	2.3
80					3.9	2.7	

Hauptausleger 71 m

Radius (m)	Nadellänge (m)						
	41	44					
14.2	t	t					
15	39.2						
18	39.2	36.8					
20	34.0	33.5					
24	30.4	29.6					
26	24.4	24.1					
28	22.5	22.0					
30	20.8	20.4					
32	19.4	19.0					
36	18.3	17.8					
38	16.1	15.9					
40	15.3	15.0					
42	14.5	14.2					
44	13.8	13.5					
48	13.1	12.9					

Traglasten in Tonnen mit verstellbarem Nadelausleger (No. 2316.xx) 124 t Ballast + 57 t Zentralballast. Oben angeführte Traglastwerte sind nur zur Information. Für Ihren aktuellen Hub verwenden Sie bitte die Traglastwerte aus dem Traglasttabellenbuch.

Traglasten - verstellb. Nadelausleger (No. 2316.xx)

Hauptausleger 83°

Hauptausleger 20 m

Radius (m)	Nadellänge (m)							
	20	41	53	65	77	89	101	113
11.5	t	t	t	t	t	t	t	t
18	110.4							
22	54.0	51.7						
24	37.4	36.0	37.1					
26	31.9	30.3	30.5					
30		27.1	27.1	28.4				
32		21.3	20.8	20.8	21.9			
36		19.6	18.9	18.5	19.0	16.4		
40		16.7	15.6	15.1	14.8	14.7	11.6	
42		14.5	13.6	12.7	11.9	12.5	10.8	8.0
44		13.5	12.5	11.5	10.9	10.8	9.9	7.9
48		12.5	11.6	10.6	9.9	9.4	9.3	7.7
55			10.2	9.2	8.2	7.5	7.1	7.3
65			8.1	7.2	6.1	5.1	4.5	4.0
70				5.0	4.0	3.0	2.1	2.2
75					3.3	2.2		
					2.6			

Hauptausleger 32 m

Radius (m)	Nadellänge (m)							
	20	41	53	65	77	89	101	113
13	t	t	t	t	t	t	t	t
20	104.7							
24	64.3	60.7						
26	45.8	49.2	44.1					
28	39.8	44.0	41.5					
30		39.5	39.1	31.1				
34		35.4	35.9	30.3	22.6			
38		29.5	30.6	28.3	22.0	15.7		
42		24.9	25.2	26.3	21.0	15.1	11.0	
44		21.6	21.5	22.2	20.0	14.5	10.6	7.6
46		20.2	19.9	20.2	19.7	14.2	10.4	7.4
55		18.7	18.5	18.6	18.4	13.9	10.2	7.2
65			13.8	13.4	13.1	11.5	9.3	6.5
80				9.8	9.2	8.6	7.4	5.6
85					5.4	4.6	4.1	3.9
90						3.8	2.9	2.7
						2.9	2.1	

Hauptausleger 41 m

Radius (m)	Nadellänge (m)							
	20	41	53	65	77	89	101	113
14	t	t	t	t	t	t	t	t
22	91.7							
24	54.3	54.4						
26	45.9	50.1	41.8					
28	41.2	43.6	40.9					
32		39.2	39.2	29.6				
36		31.9	32.6	28.6	21.4			
38		27.1	27.4	26.1	20.7	14.9		
42		25.0	25.0	24.9	20.3	14.7	10.6	
44		21.7	21.5	21.8	19.4	14.1	10.3	7.2
46		20.4	20.0	19.9	19.0	13.7	10.1	7.2
55		19.1	18.6	18.3	18.5	13.4	9.9	7.0
70			14.0	13.3	12.9	11.3	9.0	6.3
80				8.4	7.7	6.9	6.3	4.8
85					5.5	4.5	4.0	3.8
90						3.7	3.0	2.7
						2.9	2.1	

Hauptausleger 53 m

Radius (m)	Nadellänge (m)							
	20	41	53	65	77	89	101	113
15.5	t	t	t	t	t	t	t	t
22	75.8							
26	53.2	47.4						
28	40.8	41.4	35.8					
30	36.9	36.9	34.6					
34		33.6	33.3	26.4				
36		28.1	27.7	25.1	18.8			
40		26.2	25.7	23.9	18.4	13.7		
44		22.6	21.9	21.0	17.6	13.4	9.8	
48		19.9	19.1	18.3	16.4	12.9	9.5	6.7
55		17.5	16.7	15.7	15.3	12.3	9.1	6.4
60			13.7	12.6	11.6	10.9	8.4	5.9
70			11.8	10.8	9.9	9.1	7.9	5.5
80				8.1	7.1	6.4	5.4	4.2
85					5.2	4.3	3.6	2.7
95						3.6	2.7	
						2.1		

Hauptausleger 59 m

Radius (m)	Nadellänge (m)							
	20	41	53	65	77	89	101	113
16.2	t	t	t	t	t	t	t	t
24	68.5							
26	45.2	40.2						
28	40.1	37.7	31.9					
30	36.5	34.5	31.1					
34		32.1	29.7	24.3				
38		27.1	26.0	23.0	17.7			
40		23.5	22.7	20.7	17.0	13.0		
44		21.9	21.0	19.5	16.6	12.8	9.4	
46		19.3	18.5	17.2	15.2	12.3	9.1	6.3
48		18.2	17.3	16.0	14.6	12.0	8.9	6.3
60		17.2	16.2	14.9	14.1	11.6	8.7	6.1
70			11.6	10.3	9.3	8.5	7.7	5.2
80				7.8	6.8	5.9	5.0	3.9
85					5.0	4.0	3.2	2.2
90						3.3	2.4	
						2.6		

Hauptausleger 71 m

Radius (m)	Nadellänge (m)							
	41	44						
23.8	t	t						
24	31.1							
26	31.1							
28	29.9	29.0						
30	28.4	27.6						
32	26.9	26.2						
34	25.6	24.9						
36	23.9	23.7						
38	22.5	22.1						
40	21.3	20.9						
42	20.0	19.8						
44	18.7	18.6						
46	17.7	17.5						
48	16.8	16.5						
50	15.9	15.7						
	15.1	14.9						

Traglasten in Tonnen mit verstellbarem Nadelausleger (No. 2316.xx) 124 t Ballast + 57 t Zentralballast. Oben angeführte Traglastwerte sind nur zur Information. Für Ihren aktuellen Hub verwenden Sie bitte die Traglastwerte aus dem Traglasttabellenbuch

Traglasten - verstellb. Nadelausleger (No. 2316.xx)

Hauptausleger 75°

Hauptausleger 20 m

Radius (m)	Nadellänge (m)							
	20	41	53	65	77	89	101	113
18	t	t	t	t	t	t	t	t
26	76.9							
32		36.9						
36		24.9	26.3					
38		20.3	20.4	20.1				
42		18.7	18.3	18.9				
44		16.1	15.2	15.2	15.1			
46		14.9	14.2	14.0	14.7			
48		13.7	13.1	12.6	13.0	10.9		
50		12.3	12.2	11.5	11.7	10.8		
55			11.4	10.7	10.5	10.0		
60			9.7	8.9	8.2	8.0	7.4	
65				7.5	6.7	6.0	5.8	5.0
70				6.3	5.4	4.6	4.2	3.8
75				5.0	4.4	3.5	2.8	2.9
80					3.5	2.5		
					2.7			

Hauptausleger 32 m

Radius (m)	Nadellänge (m)							
	20	41	53	65	77	89	101	113
20	t	t	t	t	t	t	t	t
30	68.9							
34		42.4						
40		37.3	33.9					
44		31.1	29.5	26.8				
50		27.6	26.5	24.7	19.7			
55		23.1	22.7	21.4	19.2	13.8		
60			20.0	19.2	17.4	13.4	9.5	
65			17.2	16.9	15.8	12.7	9.3	6.3
70				15.0	14.1	11.8	8.9	6.1
75				12.8	12.4	11.1	8.6	5.8
80					11.0	9.8	8.3	5.5
85					9.3	8.6	7.6	5.2
90					7.5	7.6	6.6	4.9
95						6.3	5.8	3.3
105						4.9	4.9	
						2.7		

Hauptausleger 41 m

Radius (m)	Nadellänge (m)						
	20	41	53	65	77	89	101
22.3	t	t	t	t	t	t	t
32	58.3						
38		41.1	36.0				
42		30.1	28.9				
48		27.2	26.1	23.5			
50		23.5	22.6	20.8	18.7		
55		22.6	21.6	19.8	18.1		
60			19.2	17.7	16.2	13.1	
65			17.1	15.9	14.3	12.3	9.1
70			14.9	14.4	13.0	11.2	8.7
75				12.9	11.8	10.2	8.3
80				11.6	10.6	9.3	7.7
85					9.3	8.2	7.2
90					8.2	7.1	6.1
95						6.2	5.1
110						5.3	4.2
						2.0	2.6

Hauptausleger 50 m

Radius (m)	Nadellänge (m)						
	20	41	53	65	77	89	101
25.4	t	t	t	t	t	t	t
36	46.5						
40		15.1	29.7				
46			26.4	23.9			
48			22.9	21.0	18.8		
50			21.8	20.0	18.2		
55			21.0	19.1	17.2	14.8	
60			18.8	17.2	15.4	13.6	11.6
65				15.6	14.0	12.2	10.9
70				14.2	12.6	11.0	9.8
75					11.5	9.9	8.7
80					10.4	8.9	7.9
85						8.1	7.0
90						7.0	5.9
95						6.1	5.1
100							4.0
							2.9
							2.1
							2.4

Hauptausleger 59 m

Radius (m)	Nadellänge (m)						
	20	41	53	65	77	89	101
28	t	t	t	t	t	t	t
36	40.7						
42		31.7	27.2				
46			23.6	21.7			
48			21.5	19.7	17.0		
50			20.5	18.8	16.9		
55			19.6	17.9	16.1		
60			17.9	16.2	14.4	12.7	
65				14.6	12.9	11.3	10.0
70				13.4	11.7	10.1	8.9
75					10.6	9.2	7.9
80					9.7	8.2	7.1
85					8.5	7.4	6.3
90						6.4	5.3
95						5.5	4.5
100							3.3
							2.2
							2.6
							2.9

Hauptausleger 71 m

Radius (m)	Nadellänge (m)					
	41	44				
38.9	t	t				
40	20.8					
42	21.5					
44	20.5	20.2				
46	19.5	19.2				
48	18.6	18.3				
50	17.9	17.5				
55	17.1	16.8				
60	15.4	15.1				
	14.1	13.8				

Traglasten in Tonnen mit verstellbarem Nadelausleger (No. 2316.xx) 124 t Ballast + 57 t Zentralballast. Oben angeführte Traglastwerte sind nur zur Information. Für Ihren aktuellen Hub verwenden Sie bitte die Traglastwerte aus dem Traglasttabellenbuch

Traglasten - verstellb. Nadelausleger (No. 2316.xx)

Hauptausleger 65°

Hauptausleger 20 m

Radius (m)	Nadellänge (m)							
	20	41	53	65	77	89	101	113
24	t	t	t	t	t	t	t	t
26	51.5							
30	42.1							
36	30.2							
42		22.3						
48		15.8	15.6					
50		12.3	12.3					
55		11.3	11.0	11.2				
60			8.9	8.7				
65			7.5	6.9	6.7			
70				5.6	5.2	4.8		
75				4.6	3.9	3.5	2.8	
80					3.0	2.6	2.1	
					2.4			

Hauptausleger 32 m

Radius (m)	Nadellänge (m)							
	20	41	53	65	77	89	101	113
30	t	t	t	t	t	t	t	t
36	43.1							
42	15.1							
48		27.1						
55		22.9	21.9					
65		19.1	18.3	17.4				
70			14.5	13.7	12.7			
75				12.2	11.3	10.1		
85				10.9	9.9	8.8	7.6	
90					7.5	6.5	5.4	4.3
95					6.5	5.5	4.4	3.3
100						4.6	3.6	2.5
105						3.8	2.8	
						2.1	2.1	

Hauptausleger 41 m

Radius (m)	Nadellänge (m)							
	20	41	53	65	77	89	101	113
34	t	t	t	t	t	t	t	t
38	35.0							
44	30.5							
55		22.8						
60		17.8	16.9					
65		15.1	15.0	14.0				
70			13.4	12.4	11.3			
75			12.0	11.0	9.8			
80				9.6	8.5	7.3		
85				8.4	7.3	6.2	5.0	
90					5.4	4.3	3.2	2.0
95						3.5	2.4	
105						2.1		

Hauptausleger 53 m

Radius (m)	Nadellänge (m)						
	20	41	53	65	77	89	101
37	t	t	t	t	t	t	t
44	28.4						
50	23.1						
60		18.0					
65		14.0	13.0				
70		12.5	11.4	10.1			
75			10.0	8.8	7.5		
80			8.7	7.6	6.4		
85				6.6	5.4	4.2	
90				5.6	4.5	3.3	2.1
95					3.7	2.5	
100					2.9		
					2.3		

Hauptausleger 59 m

Radius (m)	Nadellänge (m)					
	20	41	53	65	77	89
39.6	t	t	t	t	t	t
46	24.5					
55	20.6					
60		14.6				
65		12.9	11.6			
70		11.3	10.1			
75			8.8	7.6		
80			7.7	6.5	5.2	
85				5.5	4.3	3.0
90				4.6	3.5	2.2
95				3.8	2.7	
					2.0	

Hauptausleger 71 m

Radius (m)	Nadellänge (m)				
	41	44			
56.7	t	t			
60	10.8				
65	10.1	9.9			
70	8.8	8.6			
75	7.6	7.5			
		6.4			

Traglasten in Tonnen mit verstellbarem Nadelausleger (No. 2316.xx) 124 t Ballast + 57 t Zentralballast. Oben angeführte Traglastwerte sind nur zur Information. Für Ihren aktuellen Hub verwenden Sie bitte die Traglastwerte aus dem Traglasttabellenbuch

Traglasten - verstellb. Nadelausleger (No. 2316.xx)

Hauptausleger 45°

Hauptausleger 20 m

Radius (m)	Nadellänge (m)								
	20	41	53	65	77				
33.4	t	t	t	t	t				
36	30.1								
55		12.9							
65			8.5						
75				5.5					
80				4.0					
85					3.1				
90					2.2				

Hauptausleger 32 m

Radius (m)	Nadellänge (m)								
	20	41	53	65	77				
41.9	t	t	t	t	t				
44	25.3								
60		14.5							
65		12.9							
70			10.7						
75			9.4						
80				7.2					
85				6.2					
90					4.2				
100					2.7				

Hauptausleger 41 m

Radius (m)	Nadellänge (m)							
	20	41	53	65				
48.3	t	t	t	t				
50	18.9							
70		9.6						
80			6.3					
90				3.5				
95				2.8				

Hauptausleger 53 m

Radius (m)	Nadellänge (m)						
	20	41	53				
56.8	t	t	t				
60	12.2						
60	11.2						
75		5.4					
80		4.6					
85			2.6				

Hauptausleger 59 m

Radius (m)	Nadellänge (m)					
	20	41				
61	t	t				
80	9.0	3.0				

Traglasten in Tonnen mit verstellbarem Nadelausleger (No. 2316.xx) 124 t Ballast + 57 t Zentralballast. Oben angeführte Traglastwerte sind nur zur Information. Für Ihren aktuellen Hub verwenden Sie bitte die Traglastwerte aus dem Traglasttabellenbuch

Verstellb. Nadelausleger (No. 1916.xx) 78° - 15°

Hauptausleger 88° - 45°

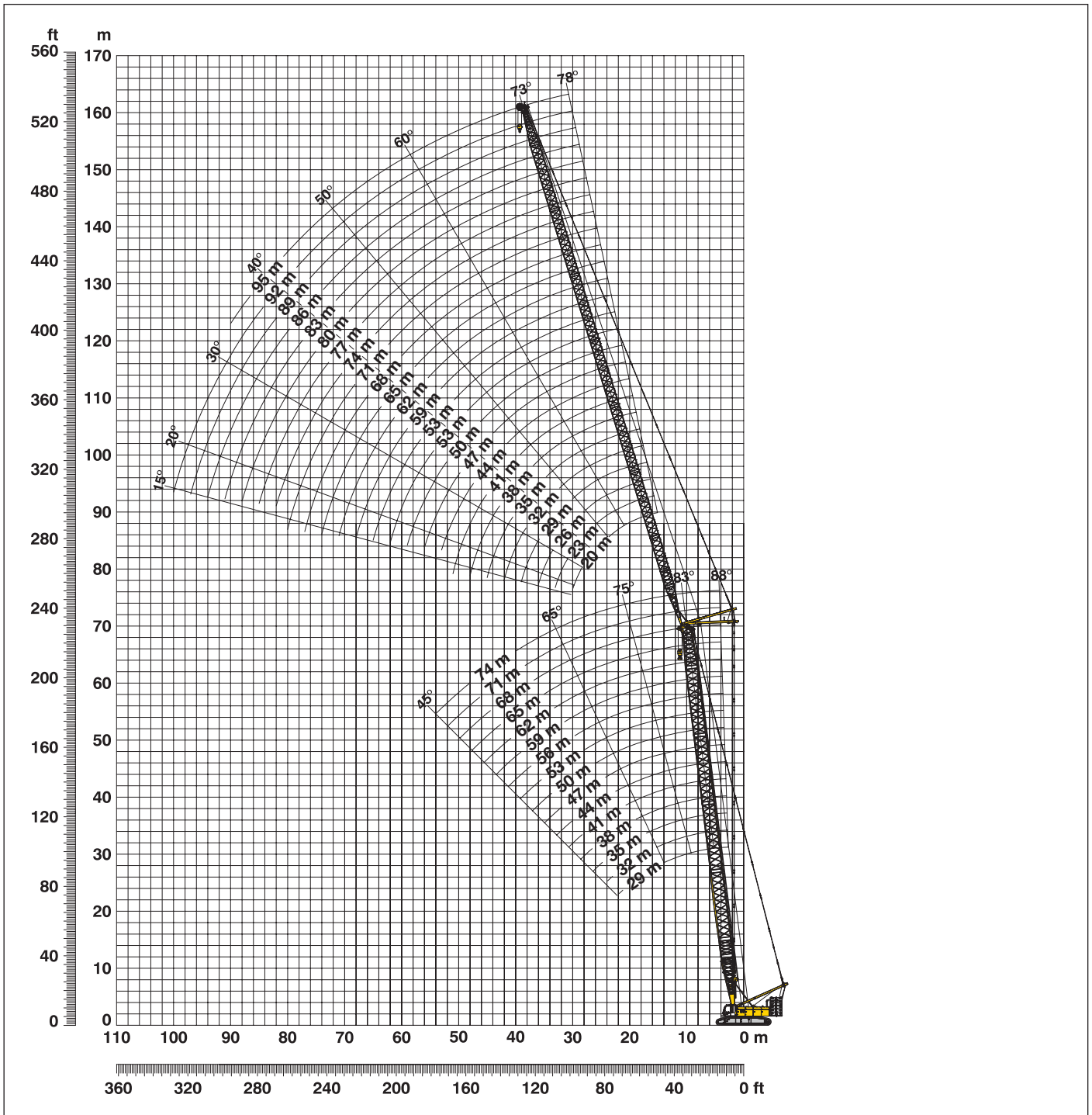

Auslegerzusammenbau für Hauptauslegerlängen von 29 m - 74 m – siehe Tabelle 1, Seite 12

Konfiguration mit verstellbarem Nadelausleger (20 m - 95 m)

Länge	Anzahl der Nadelauslegerstücke																										
	20	23	26	29	32	35	38	41	44	47	50	53	56	59	62	65	68	71	74	77	80	83	86	89	92	95	
Anlenkstück	7 m	1	1	1	1	1	1	1	1	1	1	1	1	1	1	1	1	1	1	1	1	1	1	1	1	1	
Nadel-Z-Stück	3 m		1		1	1		1		1		1		1		1		1		1		1		1		1	
Nadel-Z-Stück	6 m	1	1		1	1		1	1		1	1		1		1	1		1	1		1	1		1	1	
Nadel-Z-Stück	12 m			1	1	1	1	2	2	2	2	3	3	3	3	4	4	4	4	5	5	5	5	6	6	6	6
Kopfstück	7 m	1	1	1	1	1	1	1	1	1	1	1	1	1	1	1	1	1	1	1	1	1	1	1	1	1	
Nadellänge (m)		20	23	26	29	32	35	38	41	44	47	50	53	56	59	62	65	68	71	74	77	80	83	86	89	92	95

Traglasten - verstellb. Nadelausleger (No. 1916.xx)

Hauptausleger 88°

Hauptausleger 29 m

Radius (m)	Nadellänge (m)							
	20	29	35	47	59	71	83	95
13	t	t	46.5	t	t	t	t	t
14			44.7	31.2				
15		50.3	42.6	30.7				
17		45.9	39.4	28.8	20.3			
18	51.5	44.2	37.6	27.7	19.9			
19	48.7	42.2	36.1	26.8	19.2	13.8		
22	38.5	37.5	32.6	24.6	17.8	13.0	9.1	
24		34.4	30.4	23.3	17.1	12.5	8.8	6.0
28		29.1	26.9	21.4	16.1	11.8	8.2	5.7
32		15.1	23.8	19.8	15.5	11.2	7.8	5.3
36			20.5	18.2	14.8	10.7	7.4	5.0
48				12.9	12.7	9.4	6.4	4.2
60					9.2	8.3	5.7	3.4
70						6.8	5.2	2.8
80							4.5	2.3
85								2.0

Hauptausleger 41 m

Radius (m)	Nadellänge (m)							
	20	29	35	47	59	71	83	95
10.6	t	t	57.8	t	t	t	t	t
11	69.6	57.8						
12	65.7	55.5	45.9					
15	55.4	49.2	41.0	29.6				
17	50.6	44.8	38.1	27.8	19.4			
20	43.6	39.7	33.9	25.4	18.2	13.2		
22	39.0	36.7	31.9	24.2	17.4	12.7	8.8	
26		30.5	28.1	22.0	16.2	11.8	8.3	5.7
28		27.8	26.4	21.1	15.7	11.5	8.0	5.5
32		24.2	23.2	19.7	15.1	10.9	7.6	5.2
38			19.4	17.2	14.2	10.3	7.0	4.7
48				13.2	12.3	9.2	6.3	4.1
60					9.5	8.2	5.6	3.4
70						6.9	5.1	2.8
80							4.5	2.3
85								2.1

Hauptausleger 53 m

Radius (m)	Nadellänge (m)							
	23	29	35	47	59	71	83	95
9.8	63.6	t	t	t	t	t	t	t
11	60.7	52.4						
13	54.1	50.0	42.0					
15	48.4	45.8	39.3	27.7				
18	42.1	40.4	35.5	25.9	18.3			
20	38.8	37.1	32.9	24.4	17.5	12.6		
24	32.2	31.3	28.8	22.3	16.1	11.7	8.3	
26	29.5	28.5	27.0	21.4	15.6	11.4	8.0	5.5
32		23.0	22.0	18.9	14.6	10.6	7.4	5.0
38			18.6	16.6	13.7	10.0	6.9	4.6
50				12.3	11.2	8.9	6.1	3.9
60					9.1	7.8	5.5	3.3
65						7.3	5.3	3.1
70						6.6	5.0	2.8
80							4.3	2.3
85							3.6	2.1

Hauptausleger 59 m

Radius (m)	Nadellänge (m)							
	20	29	35	47	59	71	83	95
9.4	64.5	t	t	t	t	t	t	t
12	54.8	48.9						
13	51.5	47.3	40.1					
15	46.4	43.7	37.9	26.6				
18	40.2	38.5	34.7	25.2	17.7			
20	36.9	35.5	32.2	23.8	17.1	12.2		
24	31.1	29.9	28.0	21.8	15.8	11.5	8.2	
26		27.4	26.0	20.9	15.3	11.1	7.9	5.4
30		23.8	22.8	19.3	14.6	10.6	7.4	5.1
32		22.4	21.3	18.5	14.3	10.4	7.2	4.9
38			18.1	16.2	13.4	9.8	6.7	4.5
50				12.2	10.8	8.7	5.9	3.8
60					8.8	7.5	5.4	3.3
70						6.3	4.9	2.8
80							4.2	2.2
85							3.3	2.0

Hauptausleger 68 m

Radius (m)	Nadellänge (m)							
	20	29	35	47	59	71	83	95
9.7	56.6	t	t	t	t	t	t	t
12	50.3	43.9						
13	47.5	43.1	36.7					
16	40.4	38.9	34.4	24.8				
18	36.9	35.4	32.7	23.8	16.6			
22	31.5	29.8	28.6	21.8	15.7	11.5		
24	29.1	27.6	26.4	20.9	15.1	11.0	7.8	
28		23.6	22.8	19.6	14.4	10.5	7.4	5.1
32		20.9	20.0	17.6	13.8	10.0	7.0	4.8
38			17.1	15.3	12.7	9.4	6.6	4.4
50				11.6	10.1	8.5	5.8	3.7
60					8.2	7.0	5.3	3.2
65						6.4	4.9	3.0
70						5.8	4.6	2.7
80							3.8	2.2
85							3.4	

Hauptausleger 74 m

Radius (m)	Nadellänge (m)				
	20	29	35	47	53
9.9	51.7	t	t	t	t
12	47.6	40.4			
13	45.0	40.1	34.3		
16	38.2	36.6	32.7	23.5	
17	36.4	34.9	31.7	23.3	19.1
18	34.8	33.3	31.0	22.8	19.0
19	33.5	32.0	30.1	22.4	18.6
20	32.1	30.8	28.9	21.8	18.2
22	29.8	28.1	27.2	20.9	17.6
24	27.8	26.1	25.1	20.1	17.0
28		22.5	21.6	18.9	16.2
32		20.1	19.0	16.9	15.5
38			16.4	14.6	13.3
46				12.1	11.0
50				11.1	10.2
55					9.2

Traglasten in Tonnen mit verstellbarem Nadelausleger (No. 1916.xx) 124 t Ballast + 57 t Zentralballast. Oben angeführte Traglastwerte sind nur zur Information. Für Ihren aktuellen Hub verwenden Sie bitte die Traglastwerte aus dem Traglasttabellenbuch.

Traglasten - verstellb. Nadelausleger (No. 1916.xx)

Hauptausleger 83°

Hauptausleger 29 m

Radius (m)	Nadellänge (m)							
	20	29	35	47	59	71	83	95
12.6	t	t	t	t	t	t	t	t
16	76.5							
17	65.5	53.3						
22	61.4	50.8	42.1					
24	47.0	41.3	35.3	26.0				
26	41.3	38.6	33.1	24.6	17.5			
28	15.1	36.1	31.1	23.5	17.2			
32		33.8	29.6	22.6	16.7	12.1		
34		28.7	26.3	21.0	15.9	11.6	8.1	
36		25.4	24.9	20.4	15.6	11.3	7.9	
40			23.5	19.8	15.3	11.0	7.6	5.2
44			20.0	18.0	14.7	10.6	7.2	4.9
50				16.6	14.2	10.1	6.9	4.6
60				13.7	13.3	9.5	6.5	4.2
75					10.7	8.7	5.9	3.6
85						6.2	5.2	2.7
85						4.6	4.6	2.2

Hauptausleger 41 m

Radius (m)	Nadellänge (m)							
	20	29	35	47	59	71	83	95
14	t	t	t	t	t	t	t	t
17	71.6							
19	60.0	50.4						
22	53.8	47.1	39.2					
26	46.9	42.2	35.4	25.4				
30	39.3	37.0	31.4	23.6	16.8			
34		32.5	28.6	22.0	16.1	11.7		
36		27.8	25.5	20.5	15.4	11.2	7.8	
40		15.1	24.3	19.9	15.1	10.9	7.6	5.0
50			21.4	18.5	14.5	10.5	7.2	4.8
65				14.6	13.3	9.5	6.4	4.2
70					9.2	8.4	5.6	3.4
75						7.8	5.4	3.1
80						7.1	5.2	2.8
85							5.0	2.5
90							4.7	2.3
90							4.7	2.1

Hauptausleger 53 m

Radius (m)	Nadellänge (m)							
	20	29	35	47	59	71	83	95
15.5	t	t	t	t	t	t	t	t
19	61.8							
20	50.4	45.6						
24	47.6	44.3	36.4					
28	40.0	38.4	33.0	23.9				
32	35.3	34.1	29.9	22.5	16.1			
34		30.2	27.4	21.1	15.4	11.2		
36		28.4	25.9	20.4	15.1	10.9	7.5	
38		26.3	24.6	19.8	14.8	10.7	7.5	
42			23.5	19.2	14.6	10.5	7.3	4.8
50			20.8	17.9	14.0	10.1	6.9	4.6
55				15.2	13.2	9.4	6.4	4.1
65				11.0	12.7	9.0	6.1	3.9
75					10.1	8.3	5.6	3.4
85						7.3	5.1	2.8
90							4.7	2.3
90							4.7	2.1

Hauptausleger 59 m

Radius (m)	Nadellänge (m)							
	20	29	35	47	59	71	83	95
16.2	t	t	t	t	t	t	t	t
19	57.5							
22	48.8	43.5						
26	41.6	40.4	34.2					
28	36.1	35.1	31.0	22.7				
32	34.2	33.3	29.7	22.1	15.7			
36		29.5	27.2	20.9	15.2	10.9		
38		26.1	24.4	19.6	14.6	10.6	7.4	
40		24.2	23.2	19.0	14.3	10.4	7.2	
44			22.1	18.6	14.1	10.1	7.0	4.7
48			14.9	17.1	13.6	9.8	6.7	4.4
55				15.9	13.2	9.4	6.4	4.2
65				13.2	12.4	8.9	6.0	3.9
75					10.2	8.2	5.5	3.3
80						7.3	5.1	2.8
85							4.9	2.6
90							3.7	2.1

Hauptausleger 68 m

Radius (m)	Nadellänge (m)							
	20	29	35	47	59	71	83	95
17.3	t	t	t	t	t	t	t	t
20	50.9							
22	44.4	38.8						
26	39.8	37.6	31.9					
30	34.0	33.3	29.8	21.7				
34	30.6	29.9	27.5	20.8	14.9			
36		26.1	25.2	19.8	14.4	10.4		
38		24.7	23.7	19.1	14.1	10.2	7.1	
40		23.1	22.4	18.5	13.9	10.0	7.0	
44			21.3	18.0	13.7	9.8	6.8	4.5
55			19.1	16.7	13.2	9.5	6.6	4.3
65				13.1	11.7	8.7	5.9	3.8
70					9.9	7.9	5.4	3.3
80						7.6	5.2	3.0
85						5.0	4.8	2.5
90							4.5	2.3
90							4.3	2.1

Hauptausleger 74 m

Radius (m)	Nadellänge (m)						
	20	29	35	47	59	71	80
17.7	t	t	t	t	t	t	t
22	48.7						
24	39.5	36.5					
26	35.8	34.6	30.3				
30	33.5	32.8	29.3	21.2			
34	30.2	29.3	27.1	20.6	14.6		
36		25.6	24.8	19.5	14.2	10.3	
38		24.2	23.3	18.9	14.0	10.1	7.7
44		22.8	22.0	18.3	13.7	9.9	7.7
50			18.8	16.5	13.0	9.4	7.2
55				14.5	12.4	8.9	6.8
60				13.0	11.5	8.6	6.5
65					10.8	8.2	6.2
70					9.7	7.8	6.0
80						7.5	5.7
85						4.9	5.3
85							4.9

Traglasten in Tonnen mit verstellbarem Nadelausleger (No. 1916.xx) 124 t Ballast + 57 t Zentralballast. Oben angeführte Traglastwerte sind nur zur Information. Für Ihren aktuellen Hub verwenden Sie bitte die Traglastwerte aus dem Traglasttabellenbuch.

Traglasten - verstellb. Nadelausleger (No. 1916.xx)

Hauptausleger 75°

Hauptausleger 29 m

Radius (m)	Nadellänge (m)							
	20	29	35	47	59	71	83	95
19.2	t	t	t	t	t	t	t	t
24	64.5	44.5						
26	47.2	41.8	35.3					
30	15.1	37.2	31.9					
32		34.8	30.4	22.9				
36		30.1	27.1	21.4	15.9			
38		27.1	25.7	20.7	15.6			
42			22.8	19.3	15.1	10.9		
44			21.2	18.4	14.8	10.6		
46				17.5	14.6	10.4	7.0	
55				13.9	13.4	9.6	6.4	4.2
60					12.5	9.2	6.1	3.9
75						7.8	5.4	3.0
80							5.2	2.8
90							4.9	2.3
95								2.0

Hauptausleger 41 m

Radius (m)	Nadellänge (m)							
	20	29	35	47	59	71	83	95
22.3	t	t	t	t	t	t	t	t
28	57.6	41.6						
30	47.0	39.5	33.2					
32	44.5	37.6	31.8					
34	41.1	35.6	30.3	22.5				
40		29.0	26.1	20.7	15.3			
44			23.6	19.7	14.8	10.5		
46			22.2	18.8	14.6	10.4		
50				17.3	14.2	10.1	6.8	
55				15.5	13.6	9.6	6.5	4.2
60					13.2	9.3	6.2	3.9
70					10.5	8.6	5.7	3.4
80						7.7	5.3	2.9
85							5.2	2.6
90							5.0	2.4
95								2.2

Hauptausleger 53 m

Radius (m)	Nadellänge (m)							
	20	29	35	47	59	71	83	95
25.4	t	t	t	t	t	t	t	t
30	46.3	38.2						
32	39.9	36.0	32.1					
36	37.5	32.1	29.6					
38	15.1	30.4	28.3	21.6				
42		27.8	25.8	20.5	14.7			
44		26.4	24.6	19.9	14.7			
48			22.6	18.9	14.2	10.1		
50			21.5	18.2	14.0	10.0		
55				16.7	13.6	9.6	6.5	
60				14.7	13.2	9.2	6.2	4.0
70					11.4	8.6	5.7	3.5
75						8.4	5.5	3.2
85						6.7	5.2	2.7
95							5.0	2.3
100								2.1

Hauptausleger 59 m

Radius (m)	Nadellänge (m)							
	20	29	35	47	59	71	83	95
28	t	t	t	t	t	t	t	t
32	40.6	34.0						
34	35.6	32.1	30.0					
36	33.7	30.3	29.0					
40	32.2	27.5	26.3	21.0				
44		25.3	24.0	20.0	14.4			
46		24.2	23.0	19.4	14.3			
50			21.3	18.5	13.9	9.8		
55				16.7	13.5	9.5	6.4	
60				15.1	13.1	9.2	6.1	3.9
75					9.5	8.4	5.5	3.2
80						8.1	5.3	3.0
85						7.7	5.1	2.8
90							5.1	2.5
95							5.0	2.3
100								2.1

Hauptausleger 68 m

Radius (m)	Nadellänge (m)						
	20	29	35	47	59	71	83
29.3	t	t	t	t	t	t	t
34	34.7	29.1					
36	30.6	27.6	26.2				
40	29.0	25.0	24.1				
42	15.1	23.8	23.0	19.9			
46		22.0	21.1	18.9	13.7		
48		21.2	20.2	18.2	13.7		
50			19.5	17.5	13.5		
55				16.0	13.1	9.2	
60				14.7	12.6	9.0	6.0
65				13.5	11.9	8.7	5.8
70					11.3	8.4	5.6
75					10.4	8.2	5.4
85						7.7	5.1
90							5.0
100							4.8

Hauptausleger 74 m

Radius (m)	Nadellänge (m)				
	20	29	35	47	53
32	t	t	t	t	t
34	30.5				
36	28.7				
38	27.2	25.6			
40	25.9	24.4	23.0		
42	24.9	23.2	22.2		
44		22.3	21.3		
46		21.3	20.5	17.8	
48		20.5	19.7	17.2	15.3
50		19.8	18.9	16.7	15.0
55		19.0	18.2	16.1	14.6
60			16.7	14.8	13.5
65				13.7	12.5
70				12.7	11.6
					10.9

Traglasten in Tonnen mit verstellbarem Nadelausleger (No. 1916.xx) 124 t Ballast + 57 t Zentralballast. Oben angeführte Traglastwerte sind nur zur Information. Für Ihren aktuellen Hub verwenden Sie bitte die Traglastwerte aus dem Traglasttabellenbuch.

Traglasten - verstellb. Nadelausleger (No. 1916.xx)

Hauptausleger 65°

Hauptausleger 29 m

Radius (m)	Nadellänge (m)							
	20	29	35	47	59	71	83	95
28	t	t	t	t	t	t	t	t
32	48.3							
34	41.1	30.1						
36	38.2	37.9						
42		35.4	31.2					
44		29.4	26.8					
48			25.5	20.2				
50			22.8	19.1				
60				18.1	14.3			
65				14.2	13.2	9.4		
70					12.5	9.1	6.0	
80					11.2	8.8	5.7	3.5
85						8.0	5.3	3.0
90							5.2	2.7
95							5.1	2.5
100							5.0	2.3
100								2.1

Hauptausleger 41 m

Radius (m)	Nadellänge (m)							
	20	29	35	47	59	71	83	95
34	t	t	t	t	t	t	t	t
38	35.8							
42		30.9						
44		27.4	27.0					
48		25.9	25.5					
50		23.2	23.0	20.0				
55			21.8	19.6				
60				18.1	13.9			
65				16.4	13.6			
70				14.5	13.1	9.1		
75					12.6	8.9	5.8	
80					11.3	8.6	5.6	3.3
85						8.4	5.4	3.2
90						8.0	5.3	2.9
90							5.2	2.7
100							5.1	2.3
105								2.1

Hauptausleger 53 m

Radius (m)	Nadellänge (m)							
	20	29	35	47	59	71	83	95
37	t	t	t	t	t	t	t	t
44	29.2							
46	24.0	23.6						
50		22.3	21.9					
55		20.1	19.8					
60			17.6	16.9				
70				15.1	13.2			
75				12.3	11.6	8.8		
80					10.4	8.6	5.6	
85					9.3	8.4	5.4	3.2
90						7.5	5.3	3.0
100						6.7	5.2	2.8
105							4.5	2.4
110							3.9	2.3
110								2.1

Hauptausleger 59 m

Radius (m)	Nadellänge (m)							
	20	29	35	47	59	71	83	95
39.6	t	t	t	t	t	t	t	t
46	25.3							
50	21.6	21.1						
55		19.0	18.6					
60		16.8	16.5	15.2				
65			14.8	14.1				
70				12.7	11.9			
75				11.4	10.5	8.6		
80					9.4	8.5		
85					8.4	7.5	5.4	
90					7.4	6.7	5.3	3.1
95						5.9	5.0	2.8
100						5.1	4.4	2.7
100							3.7	2.5
105							3.1	2.3

Hauptausleger 68 m

Radius (m)	Nadellänge (m)							
	20	29	35	47	59	71	83	95
43.4	t	t	t	t	t	t	t	t
50	20.5							
55	17.7	17.0						
60		15.2	14.6					
65		13.6	13.2	12.1				
70			11.7	10.9				
75				9.7	8.8			
80				8.6	7.8	6.9		
85					6.8	6.0	5.1	
90					6.0	5.2	4.3	
95						4.5	3.6	2.7
100						3.8	3.0	2.2
100						3.2	2.5	

Hauptausleger 74 m

Radius (m)	Nadellänge (m)					
	20	29	35	47	53	
45.9	t	t	t	t	t	
48	17.7					
50	16.9					
55	16.2					
60		13.6	13.0			
65		12.3	11.8			
70			10.5	9.6	9.1	
75				8.5	8.0	
80				7.4	7.1	
85					6.2	
85					5.4	

Traglasten in Tonnen mit verstellbarem Nadelausleger (No. 1916.xx) 124 t Ballast + 57 t Zentralballast. Oben angeführte Traglastwerte sind nur zur Information. Für Ihren aktuellen Hub verwenden Sie bitte die Traglastwerte aus dem Traglasttabellenbuch.

Traglasten - verstellb. Nadelausleger (No. 1916.xx)

Hauptausleger 45°

Hauptausleger 29 m

Radius (m)	Nadellänge (m)							
	20	29	35	47	59	71	83	95
39.8	t	t	t	t	t	t	t	t
42	28.7							
48		22.5						
50		21.4						
55			18.7					
65				14.6				
75					11.4			
80					10.4			
85						8.2		
90						7.8		
95							4.9	
100							4.9	
105								2.1

Hauptausleger 41 m

Radius (m)	Nadellänge (m)							
	20	29	35	47	59	71	83	
48.3	t	t	t	t	t	t	t	
50	19.9							
50	19.0							
60		14.7						
65			12.9					
75				9.9				
85					7.2			
95						4.9		
100						4.2	3.4	
105							2.9	
110							2.4	

Hauptausleger 53 m

Radius (m)	Nadellänge (m)					
	20	29	35	47	62	
56.8	t	t	t	t	t	
60	13.3					
60	12.4					
65		10.5				
70			8.9			
80				6.2		
85				5.4		
95					3.2	
100					2.7	

Hauptausleger 59 m

Radius (m)	Nadellänge (m)				
	20	29	35	47	
61	t	t	t	t	
61	10.4				
70		7.7			
75			6.3		
85				4.0	
90				3.3	

Hauptausleger 68 m

Radius (m)	Nadellänge (m)			
	20	29	35	
67.4	t	t	t	
70	6.2			
70	5.7			
75		4.3		
80			3.1	
85			2.5	

Hauptausleger 74 m

Radius (m)	Nadellänge (m)				
	20				
71.6	t				
71.6	3.6				

Traglasten in Tonnen mit verstellbarem Nadelausleger (No. 1916.xx) 124 t Ballast + 57 t Zentralballast. Oben angeführte Traglastwerte sind nur zur Information. Für Ihren aktuellen Hub verwenden Sie bitte die Traglastwerte aus dem Traglasttabellenbuch.

Festst. Nadelausleger (No. 1713.xx) 15° und 30°

Hauptausleger 88° - 30°

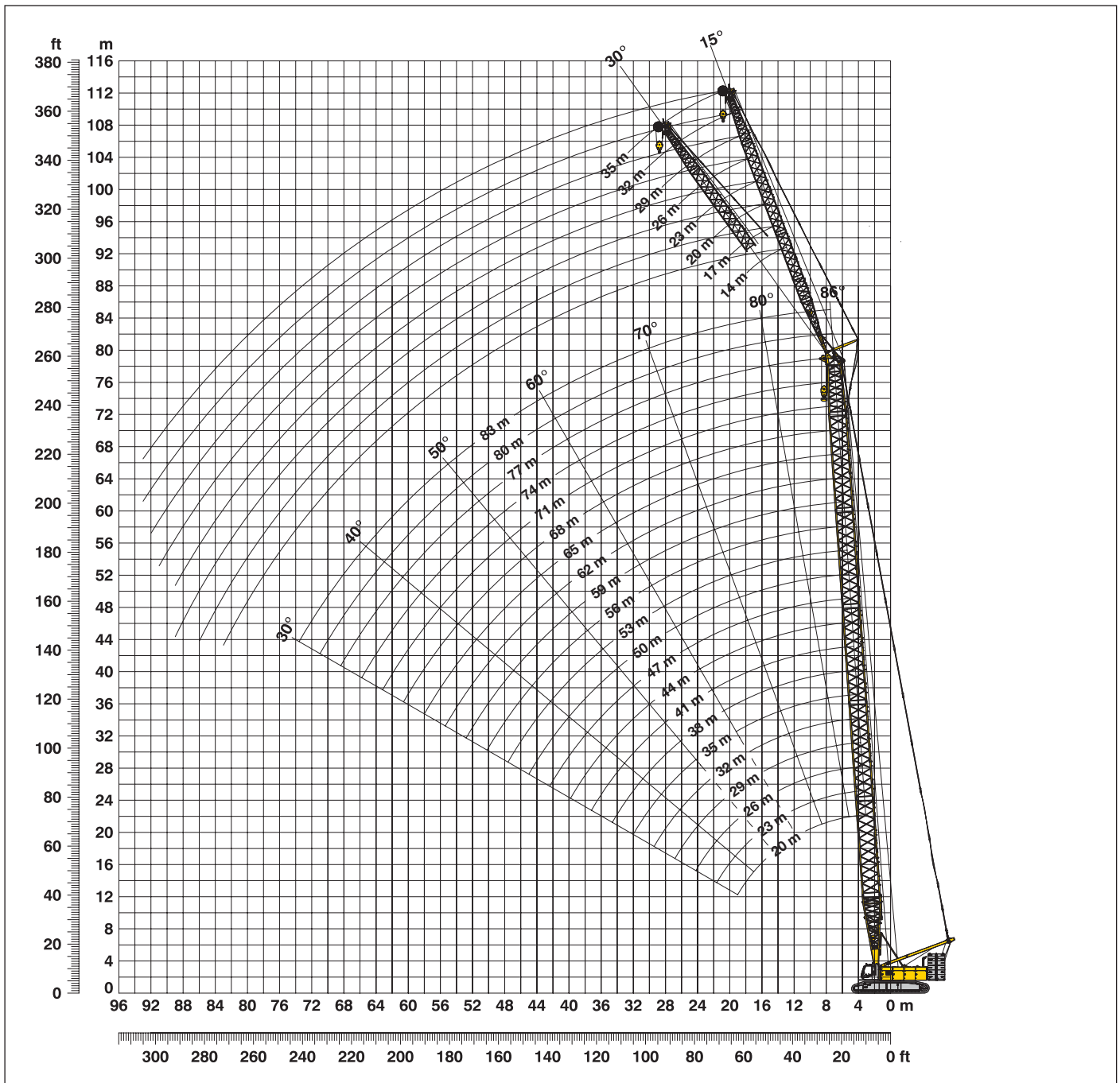

Auslegerzusammenbau für Hauptausleger von 20 m - 83 m – siehe Tabelle 1, Seite 12

Konfiguration mit feststehendem Nadelausleger (11 m - 35 m)

	Länge	Anzahl der Nadelauslegerstücke							
Nadelanlenkstück	7.0 m	1	1	1	1	1	1	1	1
Nadel-Z-Stück	3.0 m		1		1		1		1
Nadel-Z-Stück	6.0 m			1	1			1	1
Nadel-Z-Stück	12.0 m					1	1	1	1
Nadelkopf	7.0 m	1	1	1	1	1	1	1	1
Nadellänge (m)		14	17	20	23	26	29	32	35

Traglasten - festst. Nadelausleger (No. 1713.xx)

Offset 15°

Hauptausleger 20 m

Radius	Nadellänge (m)			
	14	23	29	35
(m)	t	t	t	t
13	42.9			
15	38.3	26.4		
16	36.6	25.2	21.2	18.4
18	33.9	23.2	19.3	16.7
20	31.3	21.3	17.8	15.5
24	27.6	18.6	15.5	13.4
28	24.0	16.5	13.7	11.8
32	21.7	14.7	12.2	10.6
36		13.3	11.0	9.4
42		11.7	9.6	8.1
48			8.6	7.1
50				6.9

Hauptausleger 29 m

Radius	Nadellänge (m)			
	14	23	29	35
(m)	t	t	t	t
12	53.1			
13	49.9	32.9		
14	47.4	31.1	25.6	
16	43.0	28.8	23.2	19.5
20	36.7	24.3	19.8	16.7
24	31.3	21.1	17.3	14.5
32	25.1	16.8	13.7	11.4
36	23.0	15.3	12.4	10.3
40	21.3	14.0	11.4	9.4
50		11.9	9.4	7.6
55			8.7	7.0
60				6.5

Hauptausleger 38 m

Radius	Nadellänge (m)			
	14	23	29	35
(m)	t	t	t	t
10	58.6			
12	55.6	34.5		
14	50.4	31.4	25.4	
16	46.2	29.6	23.4	19.7
20	39.7	25.2	20.4	17.1
28	31.0	20.0	16.0	13.5
36	25.9	16.5	13.2	11.1
44	22.4	14.1	11.3	9.3
48	21.1	13.3	10.5	8.7
55		12.1	9.5	7.7
60			8.9	7.2
70				5.7

Hauptausleger 47 m

Radius	Nadellänge (m)			
	14	23	29	35
(m)	t	t	t	t
9	60.0			
12	56.1	35.4		
14	52.9	32.7	26.0	
16	48.6	30.2	24.1	19.8
20	42.9	26.6	21.3	17.3
28	34.1	21.5	17.2	14.0
36	28.5	18.0	14.4	11.6
44	24.3	15.6	12.3	9.9
55	16.7	13.3	10.3	8.3
65		12.0	9.2	7.2
70			8.7	6.8
75				6.5

Hauptausleger 56 m

Radius	Nadellänge (m)			
	14	23	29	35
(m)	t	t	t	t
8.5	60.0			
12	57.1	34.9		
14	54.2	32.5	25.6	
17	48.8	29.4	23.3	19.1
20	44.6	27.0	21.3	17.6
28	36.1	22.2	17.6	14.4
36	30.5	19.0	14.9	12.2
44	23.5	16.4	12.9	10.6
65	11.4	12.1	9.7	7.7
70		10.3	9.2	7.3
75			8.8	7.0
85				6.4

Hauptausleger 62 m

Radius	Nadellänge (m)			
	14	23	29	35
(m)	t	t	t	t
8.7	60.0			
12	57.1	34.8		
15	53.2	31.5	24.7	
17	49.9	29.6	23.4	19.1
28	37.4	22.9	17.9	14.6
36	31.2	19.6	15.3	12.5
44	23.0	17.0	13.4	10.9
55	15.4	14.7	11.4	9.1
70	9.0	9.7	9.6	7.6
75		8.0	8.5	7.2
85			5.4	5.8
90				4.4

Hauptausleger 68 m

Radius	Nadellänge (m)			
	14	23	29	35
(m)	t	t	t	t
8.9	57.9			
13	53.3	33.4		
15	51.3	31.7	24.7	
17	49.3	29.9	23.4	19.1
28	39.0	23.5	18.2	14.8
36	31.1	20.1	15.7	12.8
44	22.4	17.7	13.8	11.2
55	14.9	15.1	11.8	9.5
75	6.6	7.4	7.9	7.5
80		5.7	6.3	6.6
90			3.4	3.8
95				2.6

Hauptausleger 77 m

Radius	Nadellänge (m)			
	14	23	29	35
(m)	t	t	t	t
9.2	51.4			
13	48.3	33.7		
15	46.5	31.8	24.7	
17	45.2	30.3	23.5	18.9
28	36.8	24.1	18.7	15.0
36	29.3	20.9	16.3	13.1
44	21.7	18.5	14.4	11.4
55	14.1	14.9	12.4	9.8
75	5.6	6.4	6.9	7.2
80	4.0	4.7	5.3	5.6
85		3.3	3.8	4.2
90			2.5	2.9

Hauptausleger 83 m

Radius	Nadellänge (m)			
	14	17	20	23
(m)	t	t	t	t
9.4	48.1			
11	47.0	43.0		
12	46.4	42.3	38.8	
13	45.7	41.8	37.7	32.6
16	43.4	39.8	35.1	30.4
20	41.0	37.6	32.1	27.6
28	36.1	32.7	27.5	23.7
36	28.2	26.9	24.1	20.7
44	20.7	20.9	21.0	18.6
55	13.6	13.8	14.1	14.3
75	4.9	5.1	5.4	5.6
85		2.1	2.4	2.6

Traglasten in Tonnen mit feststehendem Nadelausleger (No. 1713.xx) 124 t Ballast + 57 t Zentralballast. Oben angeführte Traglastwerte sind nur zur Information. Für Ihren aktuellen Hub verwenden Sie bitte die Traglastwerte aus dem Traglasttabellenbuch.

Traglasten - festst. Nadelausleger (No. 1713.xx)

Offset 30°

Hauptausleger 20 m

Radius	Nadellänge (m)			
	14	23	29	35
(m)	t	t	t	t
15	29.1			
18	26.3	17.7		
20	25.0	16.6	13.7	
24	23.7	14.8	12.1	10.3
28	21.7	13.7	11.1	9.3
32	20.6	13.1	10.3	8.6
34	20.2	12.7	10.0	8.2
42		11.5	8.9	7.3
46			8.5	6.8
48			8.4	6.6
50				6.4
55				6.3

Hauptausleger 29 m

Radius	Nadellänge (m)			
	14	23	29	35
(m)	t	t	t	t
14	34.1			
17	30.9	20.6		
20	28.4	18.9	15.4	
24	25.8	17.1	13.9	11.5
28	23.8	15.5	12.6	10.4
32	22.2	14.3	11.5	9.5
36	21.0	13.4	10.7	8.7
40	20.4	12.6	9.9	8.1
42	15.1	12.3	9.7	7.8
50		11.6	8.7	6.9
55			8.5	6.5
60				6.3

Hauptausleger 38 m

Radius	Nadellänge (m)			
	14	23	29	35
(m)	t	t	t	t
13	36.0			
17	32.0	20.4		
20	30.0	18.9	15.3	
24	27.3	17.3	13.9	11.6
28	25.4	16.0	12.7	10.6
32	23.7	14.9	11.8	9.7
40	21.4	13.1	10.4	8.4
44	20.7	12.5	9.8	7.9
50	15.1	11.8	9.1	7.3
55		11.5	8.6	6.9
60			8.4	6.5
70				6.3

Hauptausleger 47 m

Radius	Nadellänge (m)			
	14	23	29	35
(m)	t	t	t	t
11.4	30.1			
17	33.0	20.9		
22	29.8	18.8	14.8	
24	28.5	18.0	14.2	11.6
28	26.7	16.8	13.2	10.7
32	25.0	15.7	12.4	9.9
40	22.6	14.0	11.0	8.7
44	21.7	13.3	10.4	8.2
55	16.9	12.0	9.2	7.2
65		11.7	8.6	6.5
70			8.5	6.4
75				6.3

Hauptausleger 56 m

Radius	Nadellänge (m)			
	14	23	29	35
(m)	t	t	t	t
11.7	30.1			
17	33.5	19.7		
22	30.4	18.6	14.7	
24	29.7	18.1	14.2	11.0
32	26.3	15.9	12.4	10.1
40	23.7	14.4	11.1	9.0
48	20.8	13.1	10.1	8.1
55	16.2	12.4	9.4	7.5
65	11.5	11.6	8.7	6.8
70		10.4	8.5	6.6
80			7.6	6.3
85				6.3

Hauptausleger 62 m

Radius	Nadellänge (m)			
	14	23	29	35
(m)	t	t	t	t
11.9	30.1			
18	33.2	20.1		
22	30.9	18.7	14.7	
26	29.2	17.6	13.7	11.2
32	26.8	16.2	12.6	10.2
40	24.3	14.7	11.3	9.1
55	15.7	12.7	9.7	7.7
65	11.0	11.9	8.9	7.0
70	9.1	10.1	8.6	6.7
75		8.2	8.5	6.5
85			5.5	6.1
90				4.6

Hauptausleger 68 m

Radius	Nadellänge (m)			
	14	23	29	35
(m)	t	t	t	t
12.2	37.2			
18	33.4	20.1		
22	31.3	18.8	14.7	
26	29.8	17.8	13.8	11.2
32	27.3	16.4	12.7	10.2
40	24.8	14.9	11.5	9.2
48	19.8	13.7	10.6	8.4
65	10.6	11.5	9.1	7.1
75	6.7	7.7	8.4	6.6
80		6.0	6.7	6.4
90			3.6	4.2
95				2.8

Hauptausleger 77 m

Radius	Nadellänge (m)			
	14	23	29	35
(m)	t	t	t	t
12.5	36.7			
18	33.3	20.4		
22	31.5	19.2	14.8	
26	29.8	18.2	14.0	11.1
32	27.8	16.8	13.0	10.2
40	25.2	15.4	11.9	9.3
48	19.1	14.3	10.9	8.5
65	9.9	10.8	9.5	7.3
75	5.9	6.9	7.5	6.7
80	4.2	5.1	5.9	6.4
90		2.2	2.9	3.4
95				2.1

Hauptausleger 83 m

Radius	Nadellänge (m)			
	14	17	20	23
(m)	t	t	t	t
12.7	36.4			
15	35.0	28.5		
17	33.9	27.7	23.3	
18	33.4	27.3	23.0	19.8
24	30.8	25.2	21.2	18.2
32	27.8	22.9	19.3	16.5
40	25.0	21.0	17.8	15.2
48	18.6	18.3	16.4	14.2
55	14.1	14.4	14.7	13.4
65	9.2	9.6	10.0	10.4
75	5.2	5.5	5.9	6.2
85	2.0	2.3	2.7	3.0

Traglasten in Tonnen mit feststehendem Nadelausleger (No. 1713.xx) 124 t Ballast + 57 t Zentralballast. Oben angeführte Traglastwerte sind nur zur Information. Für Ihren aktuellen Hub verwenden Sie bitte die Traglastwerte aus dem Traglasttabellenbuch.

Festst. Nadelausleger (No. 1008.xx) 15° und 30°

Hauptausleger 88° - 30°

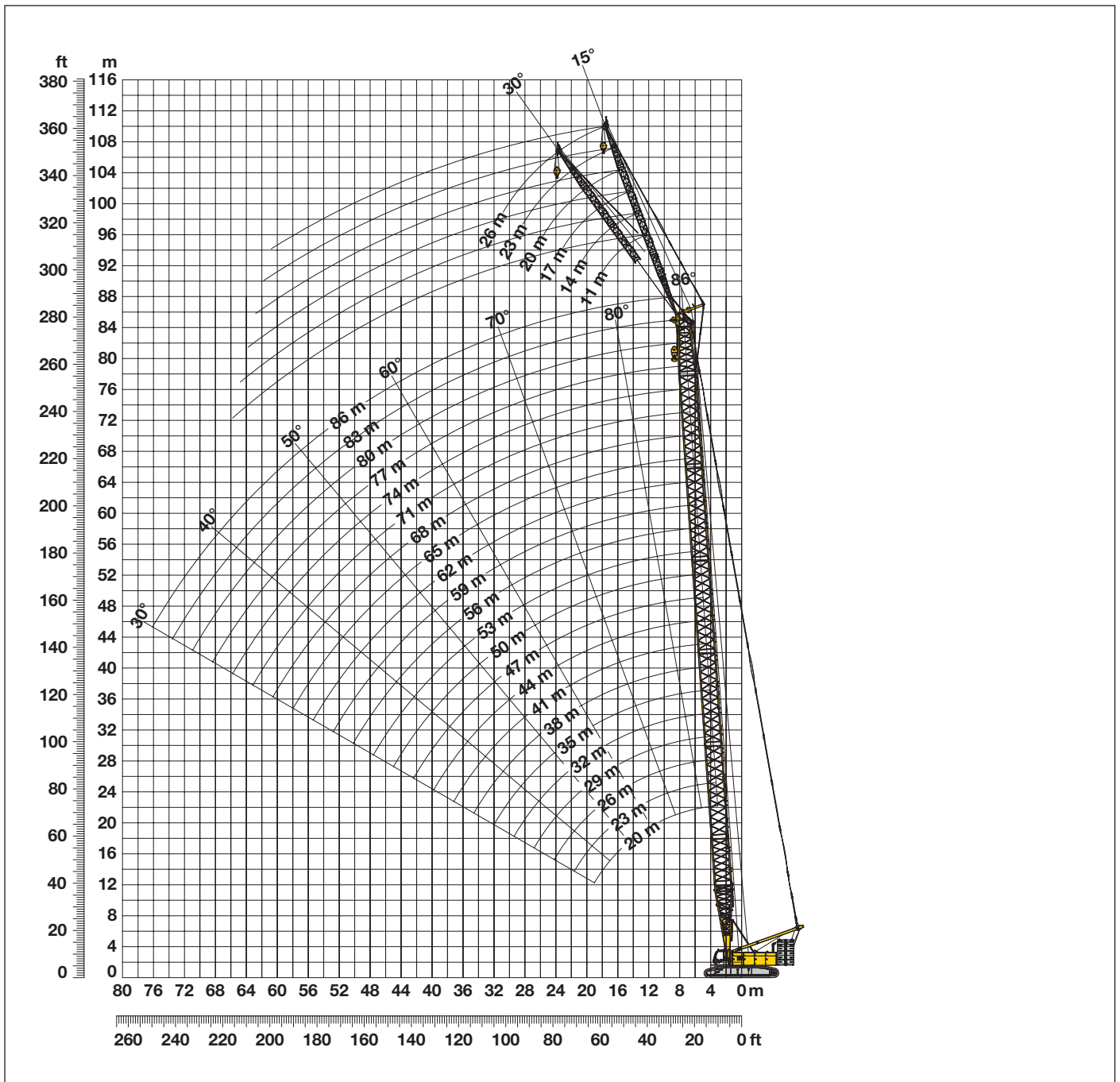

Auslegerzusammenbau für Hauptauslegerlängen von 20 m - 86 m – siehe Tabelle 1, Seite 12

Konfiguration mit feststehendem Nadelausleger (11 m - 26 m)

	Länge	Anzahl der Nadelauslegerstücke					
Nadelanlenkstück	5.5 m	1	1	1	1	1	1
Nadel-Z-Stück	3.0 m		1		1		1
Nadel-Z-Stück	6.0 m			1	1	2	2
Nadelkopf	5.5 m	1	1	1	1	1	1
Nadellänge (m)		11	14	17	20	23	26

Traglasten - festst. Nadelausleger (No. 1008.xx)

Offset 15°

Hauptausleger 20 m

Radius	Nadellänge (m)			
	11	14	20	26
(m)	t	t	t	t
13	44.3			
14	44.0	34.9		
16	40.6	33.1	23.9	
17	38.2	32.1	22.8	16.7
18	36.1	30.4	21.7	16.1
20	32.8	27.5	19.9	15.2
24	27.8	24.1	16.9	13.6
28	24.9	20.6	14.8	11.9
30	23.2	19.4	13.9	11.2
32		18.2	13.2	10.6
38			11.4	9.1
44				8.0

Hauptausleger 29 m

Radius	Nadellänge (m)			
	11	14	20	26
(m)	t	t	t	t
11	45.0			
12	45.0	38.3		
14	44.5	37.3	27.0	
16	43.8	35.8	25.2	17.6
20	38.9	32.9	22.0	15.7
28	28.9	25.4	17.0	13.2
32	26.8	22.3	15.3	11.7
36	24.1	20.2	13.9	10.7
38	22.9	19.2	13.4	10.2
40		18.3	13.0	9.8
46			11.5	8.7
50				8.2

Hauptausleger 38 m

Radius	Nadellänge (m)			
	11	14	20	26
(m)	t	t	t	t
10	45.0	39.2		
12	45.0	38.1	28.2	
14	45.0	37.0	26.6	18.9
16	43.9	36.2	25.2	17.7
20	40.9	32.7	22.9	16.0
28	33.2	26.5	18.5	13.7
36	27.0	22.0	15.2	11.6
44	23.1	18.9	13.1	10.0
46	22.3	18.2	12.7	9.6
48		17.7	12.3	9.3
55			11.1	8.4
60				7.9

Hauptausleger 47 m

Radius	Nadellänge (m)			
	11	14	20	26
(m)	t	t	t	t
9	45.0	40.2		
11	45.0	39.2	29.5	
13	44.4	38.4	28.0	19.3
16	43.2	36.5	26.0	17.8
20	39.3	33.8	23.7	16.3
28	34.3	28.9	19.9	14.1
36	30.5	26.0	16.7	12.5
44	24.4	21.6	14.5	10.8
50	19.9	19.2	13.2	9.8
55		17.3	12.4	9.1
60			11.6	8.6
65				8.1

Hauptausleger 56 m

Radius	Nadellänge (m)			
	11	14	20	26
(m)	t	t	t	t
7.1	45.0			
9	45.0	39.6		
11	45.0	38.6	28.6	
13	45.0	37.6	27.3	19.1
20	38.3	32.8	23.4	16.4
28	34.1	28.5	20.2	14.4
36	32.1	25.9	17.6	13.2
44	23.6	22.3	15.3	11.4
55	16.1	16.5	13.1	9.8
60	13.6	14.0	12.4	9.2
70			10.7	8.3
75				7.9

Hauptausleger 62 m

Radius	Nadellänge (m)			
	11	14	20	26
(m)	t	t	t	t
7.3	45.0			
9	45.0	39.4		
11	44.5	38.5	28.3	
14	43.3	36.7	26.4	18.5
20	36.9	32.1	23.4	16.3
36	30.0	25.4	18.4	13.3
44	23.1	22.4	15.9	11.9
55	15.5	15.9	13.7	10.2
65	11.0	11.3	12.0	9.0
70		9.5	10.2	8.6
75			8.6	8.3
80				7.5

Hauptausleger 68 m

Radius	Nadellänge (m)			
	11	14	20	26
(m)	t	t	t	t
7.5	45.0			
9	45.0	39.2		
11	44.1	38.3	27.8	
14	41.5	35.9	26.2	18.4
20	35.7	31.6	23.4	16.2
36	29.2	25.7	18.9	13.4
44	22.5	22.1	16.5	12.3
55	15.0	15.4	14.1	10.6
70	8.6	9.0	9.7	8.9
75		7.2	7.9	8.5
80			6.3	6.9
85				5.5

Hauptausleger 83 m

Radius	Nadellänge (m)			
	11	14	20	26
(m)	t	t	t	t
8	42.5			
10	40.5	36.8		
12	38.7	35.1	26.5	
14	36.8	33.6	25.4	17.7
20	31.6	29.6	22.9	15.8
28	28.4	26.1	20.7	14.3
36	28.4	25.4	19.3	13.4
44	21.0	21.2	17.8	12.7
55	13.6	14.0	14.5	11.2
75	5.1	5.5	6.2	6.9
85	2.1	2.5	3.2	3.8
90				2.5

Hauptausleger 86 m

Radius	Nadellänge (m)		
	11	14	17
(m)	t	t	t
8.1	42.0		
10	40.1	36.0	
11	39.2	35.1	31.6
16	34.8	31.4	28.5
20	30.8	28.8	26.8
28	26.7	24.9	23.7
36	26.7	24.5	22.7
44	20.4	20.8	20.4
55	13.3	13.7	14.2
75	4.7	5.0	5.5
80	3.1	3.5	3.9
85		2.1	2.5

Traglasten in Tonnen mit feststehendem Nadelausleger (No. 1008.xx) 124 t Ballast + 57 t Zentralballast. Oben angeführte Traglastwerte sind nur zur Information. Für Ihren aktuellen Hub verwenden Sie bitte die Traglastwerte aus dem Traglasttabellenbuch.

Traglasten - festst. Nadelausleger (No. 1008.xx)

Offset 30°

Hauptausleger 20 m

Radius	Nadellänge (m)			
	11	14	20	26
(m)	t	t	t	t
15	28.9			
16	28.0	22.9		
19	25.2	20.8	14.6	
22	22.8	18.6	13.3	10.6
24	21.4	17.5	12.5	9.9
26	20.2	16.6	11.8	9.4
28	19.4	15.8	11.2	8.9
30	18.8	15.2	10.7	8.5
32		14.8	10.3	8.0
34		14.5	9.9	7.7
40			9.3	6.9
46				6.5

Hauptausleger 29 m

Radius	Nadellänge (m)			
	11	14	20	26
(m)	t	t	t	t
13	33.3			
15	30.9	27.0		
18	28.3	24.2	16.0	
20	27.1	22.4	15.0	11.5
24	24.0	20.0	14.0	10.3
28	21.8	18.0	12.6	9.4
32	20.1	16.6	11.4	8.6
36	19.0	15.6	10.6	8.0
38	18.6	15.3	10.3	7.7
42		15.1	9.8	7.2
48			9.3	6.7
50				6.7

Hauptausleger 38 m

Radius	Nadellänge (m)			
	11	14	20	26
(m)	t	t	t	t
12	35.8			
13	34.7	27.7		
16	31.3	26.2	17.0	
19	29.1	23.8	15.7	12.0
20	28.4	23.3	15.3	11.7
24	26.3	20.8	14.5	10.6
32	22.1	17.5	12.0	9.0
40	19.5	15.6	10.5	7.9
46	18.5	14.8	9.8	7.3
48		14.6	9.6	7.1
55			9.3	6.7
60				6.6

Hauptausleger 47 m

Radius	Nadellänge (m)			
	11	14	20	26
(m)	t	t	t	t
11	37.9			
12	36.6	29.8		
15	33.5	28.5	17.9	
19	30.1	25.5	16.2	12.1
24	27.6	22.6	14.6	10.8
32	23.7	19.2	12.7	9.3
40	21.0	17.1	11.3	8.3
48	19.2	15.6	10.3	7.5
50	19.0	15.4	10.1	7.4
55		15.0	9.8	7.0
60			9.6	6.7
65				6.6

Hauptausleger 56 m

Radius	Nadellänge (m)			
	11	14	20	26
(m)	t	t	t	t
9.7	39.8			
12	37.4	30.1		
16	33.6	27.4	17.2	
19	31.1	25.5	16.1	12.1
24	28.7	23.0	14.7	10.9
32	25.3	19.8	12.9	9.7
40	22.4	17.5	11.6	8.6
48	20.3	16.1	10.6	7.8
60	13.8	14.1	9.6	7.0
65		12.0	9.5	6.8
70			9.3	6.7
75				6.6

Hauptausleger 62 m

Radius	Nadellänge (m)			
	11	14	20	26
(m)	t	t	t	t
9.9	39.6			
12	37.6	29.2		
16	34.1	27.4	17.3	
20	31.0	25.1	15.9	11.9
24	29.5	23.2	14.9	11.0
32	26.3	20.3	13.6	9.8
40	23.2	18.1	12.0	8.8
48	20.3	16.5	10.9	8.0
65	11.1	11.5	9.6	6.9
70		9.6	9.4	6.7
75			8.7	6.6
80				6.6

Hauptausleger 68 m

Radius	Nadellänge (m)			
	11	14	20	26
(m)	t	t	t	t
10.2	38.7			
12	37.0	28.8		
16	33.6	26.8	17.3	
20	30.8	24.7	16.1	11.9
32	26.0	20.4	13.9	9.9
40	23.4	18.6	12.3	8.9
48	19.8	17.1	11.2	8.2
65	10.7	11.1	9.8	7.1
70	8.8	9.2	9.5	6.9
75		7.3	8.2	6.7
80			6.5	6.7
85				5.7

Hauptausleger 83 m

Radius	Nadellänge (m)			
	11	14	20	26
(m)	t	t	t	t
10.7	32.9			
13	31.5	27.2		
17	29.0	25.0	17.2	
20	27.7	23.7	16.5	11.8
24	26.3	22.3	15.6	11.2
32	25.2	20.6	14.1	10.1
40	23.8	19.8	12.8	9.2
48	18.5	17.0	11.9	8.5
65	9.3	9.8	10.0	7.4
75	5.3	5.8	6.7	6.9
85	2.2	2.6	3.5	4.3
90			2.1	2.9

Hauptausleger 86 m

Radius	Nadellänge (m)			
	11	14	17	
(m)	t	t	t	
10.8	32.6			
13	31.0	26.3		
15	29.8	25.3	21.1	
18	28.1	23.8	20.0	
24	25.7	21.6	18.3	
32	24.8	20.0	16.6	
40	24.3	19.3	15.1	
48	18.1	16.8	14.1	
65	8.9	9.4	9.9	
75	4.9	5.4	5.9	
80	3.3	3.7	4.2	
85		2.3	2.7	

Traglasten in Tonnen mit feststehendem Nadelausleger (No. 1008.xx) 124 t Ballast + 57 t Zentralballast. Oben angeführte Traglastwerte sind nur zur Information. Für Ihren aktuellen Hub verwenden Sie bitte die Traglastwerte aus dem Traglasttabellenbuch.

Notizen

